

CALENDAR FOR THE BOARD OF SUPERVISORS
CONTRA COSTA COUNTY
AND FOR SPECIAL DISTRICTS, AGENCIES, AND AUTHORITIES GOVERNED BY THE BOARD
BOARD CHAMBERS, ADMINISTRATION BUILDING, 1025 ESCOBAR STREET
MARTINEZ, CALIFORNIA 94553-1229

KAREN MITCHOFF, CHAIR, 4TH DISTRICT
FEDERAL D. GLOVER, VICE CHAIR, 5TH DISTRICT
JOHN GIOIA, 1ST DISTRICT
CANDACE ANDERSEN, 2ND DISTRICT
DIANE BURGIS, 3RD DISTRICT

MONICA NINO, CLERK OF THE BOARD AND COUNTY ADMINISTRATOR, (925) 655-2075

PERSONS WHO WISH TO ADDRESS THE BOARD DURING PUBLIC COMMENT OR WITH RESPECT TO AN ITEM THAT IS ON THE AGENDA, MAY BE LIMITED TO TWO (2) MINUTES.
A LUNCH BREAK MAY BE CALLED AT THE DISCRETION OF THE BOARD CHAIR.

To slow the spread of COVID-19, the Health Officer's Shelter Order of September 14, 2020, prevents public gatherings ([Health Officer Order](#)). In lieu of a public gathering, the Board of Supervisors meeting will be accessible via television and live-streaming to all members of the public as permitted by the Governor's Executive Order N29-20. Board meetings are televised live on Comcast Cable 27, ATT/U-Verse Channel 99, and WAVE Channel 32, and can be seen live online at www.contracosta.ca.gov.

PERSONS WHO WISH TO ADDRESS THE BOARD DURING PUBLIC COMMENT OR WITH RESPECT TO AN ITEM THAT IS ON THE AGENDA MAY CALL IN DURING THE MEETING BY DIALING **888-251-2949** FOLLOWED BY THE ACCESS CODE **1672589#**. To indicate you wish to speak on an agenda item, please push "#2" on your phone.

All telephone callers will be limited to two (2) minutes apiece. The Board Chair may reduce the amount of time allotted per telephone caller at the beginning of each item or public comment period depending on the number of calls and the business of the day. Your patience is appreciated.

A lunch break or closed session may be called at the discretion of the Board Chair.

Staff reports related to open session items on the agenda are also accessible on line at www.contracosta.ca.gov.

ANNOTATED AGENDA & MINUTES
March 8, 2022

9:00 A.M. Convene, call to order and opening ceremonies.

Closed Session

A. CONFERENCE WITH LABOR NEGOTIATORS (Gov. Code § 54957.6)

Agency Negotiators: Monica Nino.

Employee Organizations and Unrepresented Employees: Public Employees Union, Local 1; AFSCME Locals 512 and 2700; California Nurses Assn.; SEIU Locals 1021 and 2015; District Attorney Investigators' Assn.; Deputy Sheriffs Assn.; United Prof. Firefighters I.A.F.F., Local 1230; Physicians' & Dentists' Org. of Contra Costa; Western Council of Engineers; United Chief Officers Assn.; Contra Costa County Defenders Assn.; Contra Costa County Deputy District Attorneys' Assn.; Prof. & Tech. Engineers IFPTE, Local 21; Teamsters Local 856; and all unrepresented employees.

B. PUBLIC EMPLOYEE PERFORMANCE EVALUATION

Title: County Administrator

C. CONFERENCE WITH LABOR NEGOTIATORS (Gov. Code § 54957.6)

Agency Negotiators: Karen Mitchoff, Federal Glover

Unrepresented employee: County Administrator

Inspirational Thought- *I do believe that every person has an equal opportunity to be a good and wise judge regardless of their background or life experiences.* ~ Sonia Sotomayor, US Supreme Court Associate Justice

Present: John Gioia, District I Supervisor; Candace Andersen, District II Supervisor; Diane Burgis, District III Supervisor; Karen Mitchoff, District IV Supervisor; Federal D. Glover, District V Supervisor

Staff Present: Monica Nino, County Administrator

Mary Ann McNett Mason, County Counsel

CONSIDER CONSENT ITEMS (Items listed as C.1 through C.49 on the following agenda) – Items are subject to removal from Consent Calendar by request of any Supervisor or on request for discussion by a member of the public. **Items removed from the Consent Calendar will be considered with the Discussion Items.**

PRESENTATIONS (5 Minutes Each)

PRESENTATION proclaiming March 2022 Social Work Month in Contra Costa County. (Roslyn Gentry, Employment and Human Services)

PRESENTATION recognizing March 2022 as Red Cross Awareness Month. (Supervisor Mitchoff)

Speaker: No name given.

DISCUSSION ITEMS

D.1 ACCEPT update on COVID-19; and PROVIDE direction to staff. (Anna Roth, Health Services Director)

Speakers: No Name Given; Caller 6770.

New cases of Covid-19 in Contra Costa County have dropped to 103 per day, a 33% decline from last week. Hospitalization is down to 61, a 25% decrease from last week. For comparison hospitalizations one month ago were at 235. Sadly, 96 patients passed away in January and 71 in February. The Omicron wave proved to be more deadly than the Delta wave. More people had died during this past wave because so many people got Covid at the same time.

Masking requirements were relaxed in February in the County, in alignment with state guidelines. As of March 11, 2022, masking will no longer be required indoors at K-12 schools.

Director Roth notes in regard to the callers questions about C.28 C.30 and C.31, nursing contracts: all the nurses are licensed and credentialed in the United States. These items are all agency contracts, with today's action being an update to reflect rate increases. There is no change in the payment limit on them.

AYE: District I Supervisor John Gioia, District II Supervisor Candace Andersen, District III Supervisor Diane Burgis, District IV Supervisor Karen Mitchoff, District V Supervisor Federal D. Glover

D.2 HEARING to consider an appeal of the County Planning Commission's approval of a tree permit to allow work within the dripline of 11 trees for the purpose of constructing a new single-family residence at 144 Brodia Way in unincorporated Walnut Creek. (Patrick Vaucheret - Applicant; Ezzat Akbar - Appellant) (Francisco Avila, Department of Conservation and Development)

Speakers: Appellant, Ezzat Akbari.

Written correspondence received from Michael Rost, East Municipal Utility District; Appellant Ezzat Akbari (attached).

D.3 HEARING on proposed implementation of the property tax cost recovery provisions of Revenue and Taxation Code 95.3; CONSIDER adopting report from the Auditor-Controller filed on February 1, 2022 of the 2020-21 fiscal year property tax-related costs, including the proposed charges against each local jurisdiction, excepting school entities, and CONSIDER adopting Resolution No. 2022/50 regarding implementation of Revenue and Taxation Code 95.3 for fiscal year 2021-22. (Lisa Driscoll, County Finance Director and Robert Campbell, County Auditor-Controller)

AYE: District I Supervisor John Gioia, District II Supervisor Candace Andersen, District III Supervisor Diane Burgis, District IV Supervisor Karen Mitchoff, District V Supervisor Federal D. Glover

D.4 CONSIDER authorizing the Board of Supervisors, in all its capacities, and its subcommittees, and directing its advisory bodies to continue teleconference meetings under Government Code section 54953(e), make related findings, and take related actions. (Mary Ann McNett Mason, County Counsel)

Speakers: No name given; Liz Ritchie.

ADOPTED the recommendations with amended language to change DIRECT in items number 4 and 5 to be AUTHORIZE.

The Board of Supervisors will be meeting in-person its chambers on March 29, 2022 and meetings thereafter. All advisory bodies, committees, and commissions established by the Board in all its capacities, members of staff, and participants in the meeting are welcome to continue participating in the meeting via remote is they so desire.

Masking is not required.

D. 5 CONSIDER Consent Items previously removed.

Items C.28, C.30 and C.31 regarding nursing contracts were set aside for the Health Director to answer questions from a member of the public, and subsequently adopted as presented.

Item C.14 was considered and approved in conjunction with item D.3

D. 6 PUBLIC COMMENT (2 Minutes/Speaker)

No Name Given, expressed concerns that parking meters in downtown Martinez would pose a financial and emotional burden on those who wish to attend Board meeting in person and suggested the use of a parking valet. Speaker was disturbed that an informational meeting had only one Board member, not a quorum, and objected to Board members responding to remarks she makes as a public speaker;

Chair Mitchoff clarified that many committees only have two Board members on them, so one being present constitutes a quorum, and Supervisor Gioia clarified that the meeting in question was informational only, no actions were taken

Caller 0667, spoke on the efficacy and government authorization of Covid-19 vaccines, and expressed interest in the county health services resuming the notation of how many Covid-19 fatalities were vaccinated or not vaccinated on the county website; and wonders if the population as a whole has subjected itself to acquired immune deficiency syndrome;

Cynthia LeBlanc, RCF Connects, an organization that connects established regulations. Several focus groups of black women and girls across the county were convened to understand the concerns issues and achievements. This resulted in several recommendations to ensure that black women and girls will be

valued, seen, heard, and served. There were many recommendations that came from that report, one of them being the establishment of a task force with representation from various community stakeholders as staff to guide them in addressing the recommendations. There was a press release that was issued last week, announcing the task force members. In the spirit of Black History Month and Women's History Month they are hoping to meet with each supervisor individually to review the report with them and to seek their support for these important initiatives;

Liz Ritchie, Richmond, spoke on the clinical trials of the Pfizer vaccine and read aloud a list of possible side effects.

D. 7 CONSIDER reports of Board members.

Supervisor Glover recognized the great efforts made by downtown Martinez in opening several new establishments, with great restaurants. Employees of the County and attendees of the Board meeting will have excellent opportunities for great dining;

Supervisor Andersen acknowledged how important the vaccines have been in the pandemic and expressed gratitude for their availability for family and friends and the many lives saved because of them.

ADJOURN

Adjourned today's meeting at 11:44 p.m.

CONSENT ITEMS

Road and Transportation

C. 1 APPROVE and AUTHORIZE the Public Works Director, or designee, to execute an amendment with Dewberry Engineers Inc. (dba Dewberry | Drake Haglan), acknowledging the Assignment and Assumption Agreement between Drake, Haglan & Associates, Inc. and Dewberry Engineers Inc. effective September 28, 2019, and adjusting the per phase payment limits and fixed fee amount for professional engineering services for the Byron Highway Bridge Replacement Project, with no change to the contract payment limit of \$1,403,456 or term September 11, 2018 through June 30, 2025, Byron area. (No fiscal impact)

AYE: District I Supervisor John Gioia, District II Supervisor Candace Andersen, District III Supervisor Diane Burgis, District IV Supervisor Karen Mitchoff, District V Supervisor Federal D. Glover

Engineering Services

C. 2 ADOPT Resolution No. 2022/63 approving the Final Map for subdivision SD21-09582, for a project being developed by SDC Delta Coves, LLC, as recommended by the Public Works Director, Bethel Island area. (No fiscal impact)

AYE: District I Supervisor John Gioia, District II Supervisor Candace Andersen, District III Supervisor Diane Burgis, District IV Supervisor Karen Mitchoff, District V Supervisor Federal D. Glover

C. 3 ADOPT Resolution No. 2022/67 approving the Stormwater Management Facilities Operation and Maintenance Agreement for development plan permit DP14-03041, for a project being developed by IPT Richmond DC III LLC, as recommended by the Public Works Director, Richmond area. (No fiscal impact)

AYE: District I Supervisor John Gioia, District II Supervisor Candace Andersen, District III Supervisor Diane Burgis, District IV Supervisor Karen Mitchoff, District V Supervisor Federal D. Glover

Special Districts & County Airports

C. 4 APPROVE and AUTHORIZE the Director of Airports, or designee, to execute a month-to-month hangar rental agreement with Robert Meinbress and Eric Meinbress, for a south-facing medium hangar at Buchanan Field Airport effective February 15, 2022, in the monthly amount of \$482, Pacheco area (100% Airport Enterprise Fund).

AYE: District I Supervisor John Gioia, District II Supervisor Candace Andersen, District III Supervisor Diane Burgis, District IV Supervisor Karen Mitchoff, District V Supervisor Federal D. Glover

C. 5 AUTHORIZE the Director of Airports, or designee, to submit an Airport Improvement Program (AIP) grant application to both the Federal Aviation Administration (FAA) and the California Department of Transportation-Division of Aeronautics (Caltrans) for approximately \$20,700,000 and \$150,000, respectively, to perform all related actions to replace the Air Traffic Control Tower at Buchanan Field; APPROVE and AUTHORIZE the Chair of the Board of Supervisors to sign a Statement of Acceptance; APPROVE and AUTHORIZE the Director of Airports, or designee, to sign an acceptance of up to \$150,000 of funds under the California Aid to Airports Program Grant Agreement-Federal AIP Matching Funds grant program. (90% FAA, 0.72% (maximum of \$150,000) Caltrans, and 9.28% Airport Enterprise Fund).

AYE: District I Supervisor John Gioia, District II Supervisor Candace Andersen, District III Supervisor Diane Burgis, District IV Supervisor Karen Mitchoff, District V Supervisor Federal D. Glover

Claims, Collections & Litigation

C. 6 DENY claims filed by Donald Benson, Julie Chu, Arturo Mendez, Chris and Kim Rivielle; DENY amended claim filed by Ronald Schaefer, individually and as the successor in-interest to the Estate of Joshua Schaefer.

AYE: District I Supervisor John Gioia, District II Supervisor Candace Andersen, District III Supervisor Diane Burgis, District IV Supervisor Karen Mitchoff, District V Supervisor Federal D. Glover

C. 7 RECEIVE public report of litigation settlement agreements that became final during the period of February 1, 2022, through March 3, 2022, as recommended by County Counsel.

AYE: District I Supervisor John Gioia, District II Supervisor Candace Andersen, District III Supervisor Diane Burgis, District IV Supervisor Karen Mitchoff, District V Supervisor Federal D. Glover

Honors & Proclamations

C. 8 ADOPT Resolution No. 2022/65 proclaiming March 2022 Social Work Month in Contra Costa County, as recommended by the Employment and Human Services Director.

AYE: District I Supervisor John Gioia, District II Supervisor Candace Andersen, District III Supervisor Diane Burgis, District IV Supervisor Karen Mitchoff, District V Supervisor Federal D. Glover

C. 9 ADOPT Resolution No. 2022/68 honoring Charles Boykins as an outstanding East Bay Standdown Coordinator and for his many years of service, as recommended by Supervisor Glover.

AYE: District I Supervisor John Gioia, District II Supervisor Candace Andersen, District III Supervisor Diane Burgis, District IV Supervisor Karen Mitchoff, District V Supervisor Federal D. Glover

C. 10 ADOPT Resolution No. 2022/70 recognizing March 2022 as American Red Cross Month, as recommended by Supervisor Mitchoff.

AYE: District I Supervisor John Gioia, District II Supervisor Candace Andersen, District III Supervisor Diane Burgis, District IV Supervisor Karen Mitchoff, District V Supervisor Federal D. Glover

C. 11 ADOPT Resolution No. 2022/74 declaring February 28, 2022 Rare Disease Day in Contra Costa County, as recommended by Supervisor Gioia.

AYE: District I Supervisor John Gioia, District II Supervisor Candace Andersen, District III Supervisor Diane Burgis, District IV Supervisor Karen Mitchoff, District V Supervisor Federal D. Glover

C. 12 ADOPT Resolution No. 2022/80 recognizing March 10, 2022 as the 63rd Anniversary of the Tibetan National Uprising and Affirm Support to the People of Tibet, as recommended by Supervisor Gioia.

AYE: District I Supervisor John Gioia, District II Supervisor Candace Andersen, District III Supervisor Diane Burgis, District IV Supervisor Karen Mitchoff, District V Supervisor Federal D. Glover

C. 13 ADOPT Resolution No. 2022/62 recognizing Barry Schamach on the occasion of his retirement after 31 years of service to Contra Costa County, as recommended by the Public Works Director.

AYE: District I Supervisor John Gioia, District II Supervisor Candace Andersen, District III Supervisor Diane Burgis, District IV Supervisor Karen Mitchoff, District V Supervisor Federal D. Glover

C. 14 ADOPT Resolution No. 2022/82 recognizing Lisa M. Driscoll upon the occasion of her retirement, as recommended by the County Administrator.

AYE: District I Supervisor John Gioia, District II Supervisor Candace Andersen, District III Supervisor Diane Burgis, District IV Supervisor Karen Mitchoff, District V Supervisor Federal D. Glover

Appointments & Resignations

C. 15 APPOINT Julius VanHook to the Community Based Organization Representative Seat 1, Neil Stratton to the At-Large Seat 4 on the Juvenile Justice Coordinating Council for terms ending on June 30, 2023, as recommended by the Public Protection Committee.

AYE: District I Supervisor John Gioia, District II Supervisor Candace Andersen, District III Supervisor Diane Burgis, District IV Supervisor Karen Mitchoff, District V Supervisor Federal D. Glover

Personnel Actions

C. 16 ADOPT Position Adjustment Resolution No. 25912 to add one Mental Health Specialist II (represented) position and one Mental Health Community Support Worker II (represented) position in the Behavioral Health division of the Health Services Department. (100% American Rescue Plan Act Community Mental Health Services Block Grant)

AYE: District I Supervisor John Gioia, District II Supervisor Candace Andersen, District III Supervisor Diane Burgis, District IV Supervisor Karen Mitchoff, District V Supervisor Federal D. Glover

C. 17 ADOPT Position Adjustment Resolution No. 25913 to increase the hours of one Registered Dental Assistant (represented) position from 32/40 hour part-time to full-time in the Health Services Department. (100% Hospital Enterprise Fund I)

AYE: District I Supervisor John Gioia, District II Supervisor Candace Andersen, District III Supervisor Diane Burgis, District IV Supervisor Karen Mitchoff, District V Supervisor Federal D. Glover

C. 18 ADOPT Position Adjustment Resolution No. 25914 to decrease the hours of two part-time Pediatrician-Ambulatory-Exempt (represented) positions from 31/40 to 26/40 hours and from full-time to 22/40 hours, and to increase the hours of one part-time Pediatrician-Ambulatory-Exempt (represented) position from 33/40 to 35/40 hours in the Health Services Department. (Cost savings, Hospital Enterprise Fund I)

AYE: District I Supervisor John Gioia, District II Supervisor Candace Andersen, District III Supervisor Diane Burgis, District IV Supervisor Karen Mitchoff, District V Supervisor Federal D. Glover

C. 19 ADOPT Position Adjustment Resolution No. 25915 to add one Assistant Director of Safety and Performance Improvement (represented) position, one Associate Medical Director-Exempt position, and one Chief Operating Officer-Exempt position in the Health Services Department. (100% State Public Health Workforce Development)

AYE: District I Supervisor John Gioia, District II Supervisor Candace Andersen, District III Supervisor Diane Burgis, District IV Supervisor Karen Mitchoff, District V Supervisor Federal D. Glover

C. 20 ADOPT Position Adjustment Resolution No. 25916 to add three Nutrition Assistant (represented) positions in the Health Services Department. (100% State)

AYE: District I Supervisor John Gioia, District II Supervisor Candace Andersen, District III Supervisor Diane Burgis, District IV Supervisor Karen Mitchoff, District V Supervisor Federal D. Glover

Leases

C. 21 APPROVE and AUTHORIZE the Public Works Director, or designee, to execute a lease amendment with Flavio Hernandez to extend through February 28, 2027, the term of the lease for the County-owned property located at 5830 Pacheco Boulevard, Pacheco, for the Rancho Grande Taqueria restaurant at an annual rent of \$36,000 for the first year, with annual increases thereafter. (100% General Fund)

AYE: District I Supervisor John Gioia, District II Supervisor Candace Andersen, District III Supervisor Diane Burgis, District IV Supervisor Karen Mitchoff, District V Supervisor Federal D. Glover

Grants & Contracts

APPROVE and AUTHORIZE execution of agreements between the County and the following agencies for receipt of fund and/or services:

C. 22 APPROVE and AUTHORIZE the Health Services Director, or designee, to execute a contract with Public Health Foundation Enterprises, Inc. (dba Heluna Health), to pay the County an amount of up to \$135,249 for training and participation in the Continuity of Operations Plan for state-wide COVID emergency testing for the period January 1, 2021 through September 22, 2022. (100% State, No County match)

AYE: District I Supervisor John Gioia, District II Supervisor Candace Andersen, District III Supervisor Diane Burgis, District IV Supervisor Karen Mitchoff, District V Supervisor Federal D. Glover

C. 23 APPROVE and AUTHORIZE the County Librarian, or designee, to apply for and accept a grant in the amount of \$5,000 from East Bay Community Foundation, administered by the Rodeo Municipal Advisory Council, for Rodeo Library services, pursuant to the local refinery Good Neighbor Agreement for the period July 1 through December 31, 2022. (Library Fund, no County match)

AYE: District I Supervisor John Gioia, District II Supervisor Candace Andersen, District III Supervisor Diane Burgis, District IV Supervisor Karen Mitchoff, District V Supervisor Federal D. Glover

APPROVE and AUTHORIZE execution of agreement between the County and the following parties as noted for the purchase of equipment and/or services:

C. 24 APPROVE and AUTHORIZE the Conservation and Development Director, as fiscal agent for a portion of the East Bay Regional Park District (EBRPD) Measure WW Local Grant funds, to execute and submit to EBRPD a Park Use Agreement with Urban Tilth, a nonprofit corporation, in an amount not to exceed \$306,715 to continue development of the Roots and Restoration Farm at 323 Brookside Drive in North Richmond; and to apply to EBRPD to reallocate \$16,805.12 of the \$3,046,374 of Measure WW funds awarded to the County to the Roots and Restoration Farm project. (100% EBRPD Measure WW funds)

AYE: District I Supervisor John Gioia, District II Supervisor Candace Andersen, District III Supervisor Diane Burgis, District IV Supervisor Karen Mitchoff, District V Supervisor Federal D. Glover

C. 25 APPROVE and AUTHORIZE the Health Services Director, or designee, to execute a contract amendment with Premier Surgery Center, L.P., to include the compensation for certain anesthesia-related dental services for developmentally disabled adult CCHP members, with no change in the payment limit of \$5,000,000 and no change in the original term of September 1, 2020 through August 31, 2022. (100% Contra Costa Health Plan Enterprise Fund II)

AYE: District I Supervisor John Gioia, District II Supervisor Candace Andersen, District III Supervisor Diane Burgis, District IV Supervisor Karen Mitchoff, District V Supervisor Federal D. Glover

C. 26 APPROVE and AUTHORIZE the Public Works Director, or designee, to execute a contract amendment with Hawley, Peterson & Snyder, Architects, effective March 8, 2022, to extend the term from October 8, 2022 through October 8, 2023, and increase the payment limit by \$500,000 to a new payment limit of \$1,250,000 to provide on-call architectural services for various facilities projects, Countywide. (100% Various Funds)

AYE: District I Supervisor John Gioia, District II Supervisor Candace Andersen, District III Supervisor Diane Burgis, District IV Supervisor Karen Mitchoff, District V Supervisor Federal D. Glover

C. 27 APPROVE and AUTHORIZE the Health Services Director, or designee, to execute a contract with Seva Homecare, LLC (dba Alliance Home Health Care), in an amount not to exceed \$225,000 to provide home health care services to Contra Costa Health Plan members and County recipients for the period March 1, 2022 through February 28, 2023. (100% Contra Costa Health Plan Enterprise Fund II)

AYE: District I Supervisor John Gioia, District II Supervisor Candace Andersen, District III Supervisor Diane Burgis, District IV Supervisor Karen Mitchoff, District V Supervisor Federal D. Glover

C. 28 APPROVE and AUTHORIZE the Health Services Director, or designee, to execute a contract amendment with Medical Solutions, LLC (dba Nebraska Medical Solutions), effective March 1, 2022, to increase the crisis rates for temporary nurse staffing services at Contra Costa Regional Medical Center, Health Centers and Detention Facilities with no change in the payment limit of \$4,800,000 or term July 1, 2021 through June 30, 2022. (100% Hospital Enterprise Fund I)

AYE: District I Supervisor John Gioia, District II Supervisor Candace Andersen, District III Supervisor Diane Burgis, District IV Supervisor Karen Mitchoff, District V Supervisor Federal D. Glover

C. 29 APPROVE and AUTHORIZE the Purchasing Agent to execute, on behalf of the Health Services Director, a purchase order with the California Department of Technology, in an amount not to exceed \$12,235,000 for the procurement of Microsoft M365 G5 licenses for Contra Costa Health Services; and APPROVE and AUTHORIZE the Health Services Director, or designee, to execute a contract with the California Department of Technology for Microsoft software licenses for the period March 1, 2022 to March 31, 2026. (80% Hospital Enterprise Fund I, 20% Epidemiology and Laboratory Capacity Grant)

AYE: District I Supervisor John Gioia, District II Supervisor Candace Andersen, District III Supervisor Diane Burgis, District IV Supervisor Karen Mitchoff, District V Supervisor Federal D. Glover

C. 30 APPROVE and AUTHORIZE the Health Services Director, or designee, to execute a contract amendment with AYA Healthcare, Inc., effective March 1, 2022, to increase the crisis rates for temporary nursing services for Contra Costa Regional Medical Center and Health Centers with no change in the payment limit of \$3,000,000 or term July 1, 2021 through June 30, 2022. (100% Hospital Enterprise Fund I)

AYE: District I Supervisor John Gioia, District II Supervisor Candace Andersen, District III Supervisor Diane Burgis, District IV Supervisor Karen Mitchoff, District V Supervisor Federal D. Glover

C. 31 APPROVE and AUTHORIZE the Health Services Director, or designee, to execute a contract amendment with Maxim Healthcare Services, Inc., effective March 1, 2022, to increase the crisis rates for temporary nurse staffing services at Contra Costa Regional Medical Center and Health Centers with no change in the payment limit of \$2,000,000 or term July 1, 2021 through June 30, 2022. (100% Hospital Enterprise Fund I)

AYE: District I Supervisor John Gioia, District II Supervisor Candace Andersen, District III Supervisor Diane Burgis, District IV Supervisor Karen Mitchoff, District V Supervisor Federal D. Glover

C. 32 APPROVE and AUTHORIZE the Purchasing Agent, or designee, to execute on behalf of the Public Works Director, a purchase order with Air Products Group in an amount not to exceed \$550,000 for heating, ventilation and air conditioning filtration components for the period of March 8, 2022 through February 28, 2024, Countywide. (100% General Fund)

AYE: District I Supervisor John Gioia, District II Supervisor Candace Andersen, District III Supervisor Diane Burgis, District IV Supervisor Karen Mitchoff, District V Supervisor Federal D. Glover

C. 33 APPROVE and AUTHORIZE the Human Resources Director, or designee, to execute a contract amendment with Segal Advisors, Inc. to increase the payment limit by \$60,000 to a new payment limit of \$270,000 and to extend the term from April 1, 2022 through March 31, 2023 for additional fiduciary consulting services. (100% Plan Participant Fees)

AYE: District I Supervisor John Gioia, District II Supervisor Candace Andersen, District III Supervisor Diane Burgis, District IV Supervisor Karen Mitchoff, District V Supervisor Federal D. Glover

C. 34 APPROVE and AUTHORIZE the Health Services Director, or designee, to execute a contract with Robin Wendy Asher, M.D., in an amount not to exceed \$239,616 to provide outpatient psychiatric care services to children and adolescents in Central Contra Costa County for the period April 1, 2022 through March 31, 2023. (50% Federal Medi-Cal, 50% Mental Health Realignment)

AYE: District I Supervisor John Gioia, District II Supervisor Candace Andersen, District III Supervisor Diane Burgis, District IV Supervisor Karen Mitchoff, District V Supervisor Federal D. Glover

C. 35 APPROVE and AUTHORIZE the Health Services Director, or designee, to execute a contract amendment with the U.S. Department of Veterans Affairs, Northern California Health Care System, to increase the payment limit by \$680,000 to a new payment limit of \$2,974,377 and extend the term from March 31, 2022 to March 31, 2023 to continue providing nuclear medicine services at Contra Costa Regional Medical Center. (100% Hospital Enterprise Fund I)

AYE: District I Supervisor John Gioia, District II Supervisor Candace Andersen, District III Supervisor Diane Burgis, District IV Supervisor Karen Mitchoff, District V Supervisor Federal D. Glover

C. 36 APPROVE and AUTHORIZE the Health Services Director, or designee, to execute a contract with Golden State Dermatology Associates, Inc., in an amount not to exceed \$1,200,000 to provide dermatology and otolaryngology services to Contra Costa Health Plan members and County recipients for the period April 1, 2022 through March 31, 2025. (100% Contra Costa Health Plan Enterprise Fund II)

AYE: District I Supervisor John Gioia, District II Supervisor Candace Andersen, District III Supervisor Diane Burgis, District IV Supervisor Karen Mitchoff, District V Supervisor Federal D. Glover

C. 37 APPROVE and AUTHORIZE the Health Services Director, or designee, to execute a contract with John Muir Health, Inc. (dba Community Health Improvement), in an amount not to exceed \$3,000 for the County's use of a mobile van to provide healthcare services to low-income persons for the period January 1, 2022 through December 31, 2022. (100% Federal Healthcare for the Homeless Grant)

AYE: District I Supervisor John Gioia, District II Supervisor Candace Andersen, District III Supervisor Diane Burgis, District IV Supervisor Karen Mitchoff, District V Supervisor Federal D. Glover

C. 38 APPROVE and AUTHORIZE the Purchasing Agent to execute, on behalf of the Sheriff-Coroner, a purchase order with Surtec Inc., in the amount of \$450,000 to supply the County's detention facilities with custodial supplies/specialty products and janitorial equipment repair for the period March 1, 2022 through February 28, 2023. (100% General Fund)

AYE: District I Supervisor John Gioia, District II Supervisor Candace Andersen, District III Supervisor Diane Burgis, District IV Supervisor Karen Mitchoff, District V Supervisor Federal D. Glover

AYE: District I Supervisor John Gioia, District II Supervisor Candace Andersen, District III Supervisor Diane Burgis, District IV Supervisor Karen Mitchoff, District V Supervisor Federal D. Glover

Other Actions

C. 39 APPROVE Administrative Bulletin 110.5 Legislation, Regulation, and Intergovernmental Relations, as recommended by the County Administrator and the Legislation Committee.

AYE: District I Supervisor John Gioia, District II Supervisor Candace Andersen, District III Supervisor Diane Burgis, District IV Supervisor Karen Mitchoff, District V Supervisor Federal D. Glover

C. 40 APPROVE AND AUTHORIZE the Clerk-Recorder, or designee, to execute a contract with the City of Brentwood at no cost to rent the Brentwood Community Center for the April 5, 2022 Assembly District 11 Special Election, as recommended by the Clerk-Recorder.

AYE: District I Supervisor John Gioia, District II Supervisor Candace Andersen, District III Supervisor Diane Burgis, District IV Supervisor Karen Mitchoff, District V Supervisor Federal D. Glover

C. 41 APPROVE AND AUTHORIZE the Clerk-recorder, or designee, to execute a contract with the City of Brentwood at no cost to rent the Brentwood Community Center for the June 7, 2022 Gubernatorial Primary Election, as recommended by the Clerk-Recorder.

AYE: District I Supervisor John Gioia, District II Supervisor Candace Andersen, District III Supervisor Diane Burgis, District IV Supervisor Karen Mitchoff, District V Supervisor Federal D. Glover

C. 42 APPROVE AND AUTHORIZE the Clerk-Recorder, or designee, the execute a contract with the City of Brentwood at no cost to rent the Brentwood Community Center for the November 8, 2022 Consolidated General Election, as recommended by the Clerk-Recorder.

AYE: District I Supervisor John Gioia, District II Supervisor Candace Andersen, District III Supervisor Diane Burgis, District IV Supervisor Karen Mitchoff, District V Supervisor Federal D. Glover

C. 43 ACCEPT the quarterly donation report from the Animal Services Department for the period of October 1, 2021 through December 31, 2021, as recommended by the Animal Services Director. (No Fiscal Impact)

AYE: District I Supervisor John Gioia, District II Supervisor Candace Andersen, District III Supervisor Diane Burgis, District IV Supervisor Karen Mitchoff, District V Supervisor Federal D. Glover

C. 44 APPROVE and AUTHORIZE the County Administrator, or designee, to execute an Acknowledgement of Subordination with the Successor Agency to the Hercules Redevelopment Agency, in connection with an upcoming issuance of tax allocation refunding bonds by the Successor Agency, as recommended by the County Administrator. (No immediate fiscal impact)

AYE: District I Supervisor John Gioia, District II Supervisor Candace Andersen, District III Supervisor Diane Burgis, District IV Supervisor Karen Mitchoff, District V Supervisor Federal D. Glover

C. 45 UPDATE the official list of persons to serve, in priority order, as standby officers for the respective members of the Board of Supervisors, as recommended by the County Administrator.

AYE: District I Supervisor John Gioia, District II Supervisor Candace Andersen, District III Supervisor Diane Burgis, District IV Supervisor Karen Mitchoff, District V Supervisor Federal D. Glover

C. 46 APPROVE participation in the California Office of the Small Business Advocate's California Microbusiness COVID-19 Relief Grant Program through delegating program administration to Chabot-Las Positas Community College District, and AUTHORIZE the Conservation and Development Director to send a letter of support for the District's application on behalf of the County, to give local microenterprises access to the \$1,454,492 in funds allocated to Contra Costa County. (No fiscal impact)

AYE: District I Supervisor John Gioia, District II Supervisor Candace Andersen, District III Supervisor Diane Burgis, District IV Supervisor Karen Mitchoff, District V Supervisor Federal D. Glover

C. 47 APPROVE and AUTHORIZE the Sheriff-Coroner, or designee to enter into a Site License Agreement with the Contra Costa Community College District to allow the County, through the Office of the Sheriff, to install, access, and maintain outdoor emergency sirens on property owned by the Contra Costa Community College District commencing on March 8, 2022, and renewing automatically on a yearly basis. (No fiscal impact)

AYE: District I Supervisor John Gioia, District II Supervisor Candace Andersen, District III Supervisor Diane Burgis, District IV Supervisor Karen Mitchoff, District V Supervisor Federal D. Glover

C. 48 RECEIVE the Sheriff-Coroner's FY 2020/21 Annual P-6 Zone Deployment Report, from the County Service Area P-6 Zone Central Administrative Base Fund to provide police protection services in certain unincorporated county areas and partially fund the Sheriff's Helicopter Program. (No fiscal impact)

AYE: District I Supervisor John Gioia, District II Supervisor Candace Andersen, District III Supervisor Diane Burgis, District IV Supervisor Karen Mitchoff, District V Supervisor Federal D. Glover

C. 49 AUTHORIZE the Board Chair to sign, on behalf of the Board of Supervisors, the argument in favor and any associated rebuttal argument related to a tax measure on the June 7, 2022 election ballot that would extend the Contra Costa County Abandoned Vehicle Abatement Program and Fee, as recommended by the Conservation and Development Director. (No fiscal impact)

AYE: District I Supervisor John Gioia, District II Supervisor Candace Andersen, District III Supervisor Diane Burgis, District IV Supervisor Karen Mitchoff, District V Supervisor Federal D. Glover

GENERAL INFORMATION

The Board meets in all its capacities pursuant to Ordinance Code Section 24-2.402, including as the Housing Authority and the Successor Agency to the Redevelopment Agency. Persons who wish to address the Board should complete the form provided for that purpose and furnish a copy of any written statement to the Clerk.

Any disclosable public records related to an open session item on a regular meeting agenda and distributed by the Clerk of the Board to a majority of the members of the Board of Supervisors less than 96 hours prior to that meeting are available for public inspection at 1025 Escobar Street, First Floor, Martinez, CA 94553, during normal business hours.

All matters listed under CONSENT ITEMS are considered by the Board to be routine and will be enacted by one motion. There will be no separate discussion of these items unless requested by a member of the Board or a member of the public prior to the

time the Board votes on the motion to adopt.

Persons who wish to speak on matters set for PUBLIC HEARINGS will be heard when the Chair calls for comments from those persons who are in support thereof or in opposition thereto. After persons have spoken, the hearing is closed and the matter is subject to discussion and action by the Board. Comments on matters listed on the agenda or otherwise within the purview of the Board of Supervisors can be submitted to the office of the Clerk of the Board via mail: Board of Supervisors, 1025 Escobar Street, First Floor, Martinez, CA 94553 or to clerkoftheboard@cob.cccounty.us.

The County will provide reasonable accommodations for persons with disabilities planning to attend Board meetings who contact the Clerk of the Board at least 24 hours before the meeting, at (925) 655-2000. An assistive listening device is available from the Clerk, First Floor.

Copies of recordings of all or portions of a Board meeting may be purchased from the Clerk of the Board. Please telephone the Office of the Clerk of the Board, (925) 655-2000, to make the necessary arrangements.

Forms are available to anyone desiring to submit an inspirational thought nomination for inclusion on the Board Agenda. Forms may be obtained at the Office of the County Administrator or Office of the Clerk of the Board, 1025 Escobar Street, Martinez, California.

Subscribe to receive the weekly Board Agenda by calling the Office of the Clerk of the Board, (925) 655-2000 or using the County's on line subscription feature at the County's Internet Web Page, where agendas and supporting information may also be viewed:

www.contracosta.ca.gov

STANDING COMMITTEES

The **Airport Committee** (Supervisors Karen Mitchoff and Diane Burgis) meets quarterly on the second Wednesday of the month at 11:00 a.m. at the Director of Airports Office, 550 Sally Ride Drive, Concord.

The **Family and Human Services Committee** (Supervisors John Gioia and Candace Andersen) meets on the fourth Monday of the month at 9:00 a.m. in Room 110, County Administration Building, 1025 Escobar Street, Martinez.

The **Finance Committee** (Supervisors John Gioia and Karen Mitchoff) meets on the first Monday of the month at 9:00 a.m. in Room 110, County Administration Building, 1025 Escobar Street, Martinez.

The **Hiring Outreach Oversight Committee** (Supervisors Federal D. Glover and John Gioia) meets quarterly on the first Monday of the month at 10:30 a.m. in Room 110, County Administration Building, 1025 Escobar Street, Martinez.

The **Internal Operations Committee** (Supervisors Candace Andersen and Diane Burgis) meets on the second Monday of the month at 10:30 a.m. in Room 110, County Administration Building, 1025 Escobar Street, Martinez.

The **Legislation Committee** (Supervisors Karen Mitchoff and Diane Burgis) meets on the second Monday of the month at 1:00 p.m. in Room 110, County Administration Building, 1025 Street, Martinez.

The **Public Protection Committee** (Supervisors Andersen and Federal D. Glover) meets on the fourth Monday of the month at 10:30 a.m. in Room 110, County Administration Building, 1025 Escobar Street, Martinez.

The **Sustainability Committee** (Supervisors Federal D. Glover and John Gioia) meets on the fourth Monday of every other month at 1:00 p.m. in Room 110, County Administration Building, 1025 Escobar Street, Martinez.

The **Transportation, Water & Infrastructure Committee** (Supervisors Candace Andersen and Karen Mitchoff) meets on the second Monday of the month at 9:00 a.m. in Room 110, County Administration Building, 1025 Escobar Street, Martinez.

AGENDA DEADLINE: Thursday, 12 noon, 12 days before the Tuesday Board meetings.

Glossary of Acronyms, Abbreviations, and other Terms (in alphabetical order):

Contra Costa County has a policy of making limited use of acronyms, abbreviations, and industry-specific language in its Board of Supervisors meetings and written materials. Following is a list of commonly used language that may appear in oral presentations and written materials associated with Board meetings:

AB Assembly Bill
ABAG Association of Bay Area Governments
ACA Assembly Constitutional Amendment
ADA Americans with Disabilities Act of 1990
AFSCME American Federation of State County and Municipal Employees
AICP American Institute of Certified Planners
AIDS Acquired Immunodeficiency Syndrome
ALUC Airport Land Use Commission
AOD Alcohol and Other Drugs
ARRA American Recovery & Reinvestment Act of 2009
BAAQMD Bay Area Air Quality Management District
BART Bay Area Rapid Transit District
BayRICS Bay Area Regional Interoperable Communications System
BCDC Bay Conservation & Development Commission
BGO Better Government Ordinance
BOS Board of Supervisors
CALTRANS California Department of Transportation
CalWIN California Works Information Network
CalWORKS California Work Opportunity and Responsibility to Kids
CAER Community Awareness Emergency Response
CAO County Administrative Officer or Office
CCCPCD (ConFire) Contra Costa County Fire Protection District
CCHP Contra Costa Health Plan
CCTA Contra Costa Transportation Authority
CCRMC Contra Costa Regional Medical Center
CCWD Contra Costa Water District
CDBG Community Development Block Grant
CFDA Catalog of Federal Domestic Assistance
CEQA California Environmental Quality Act
CIO Chief Information Officer
COLA Cost of living adjustment
ConFire (CCCPCD) Contra Costa County Fire Protection District
CPA Certified Public Accountant
CPI Consumer Price Index
CSA County Service Area
CSAC California State Association of Counties
CTC California Transportation Commission
dba doing business as
DSRIP Delivery System Reform Incentive Program
EBMUD East Bay Municipal Utility District
ECCPCD East Contra Costa Fire Protection District
EIR Environmental Impact Report
EIS Environmental Impact Statement
EMCC Emergency Medical Care Committee
EMS Emergency Medical Services
EPSDT Early State Periodic Screening, Diagnosis and Treatment Program (Mental Health)
et al. et alii (and others)
FAA Federal Aviation Administration
FEMA Federal Emergency Management Agency
F&HS Family and Human Services Committee
First 5 First Five Children and Families Commission (Proposition 10)
FTE Full Time Equivalent
FY Fiscal Year

GHAD Geologic Hazard Abatement District
GIS Geographic Information System
HCD (State Dept of) Housing & Community Development
HHS (State Dept of) Health and Human Services
HIPAA Health Insurance Portability and Accountability Act
HIV Human Immunodeficiency Syndrome
HOV High Occupancy Vehicle
HR Human Resources
HUD United States Department of Housing and Urban Development
IHSS In-Home Supportive Services
Inc. Incorporated
IOC Internal Operations Committee
ISO Industrial Safety Ordinance
JPA Joint (exercise of) Powers Authority or Agreement
Lamorinda Lafayette-Moraga-Orinda Area
LAFCo Local Agency Formation Commission
LLC Limited Liability Company
LLP Limited Liability Partnership
Local 1 Public Employees Union Local 1
LVN Licensed Vocational Nurse
MAC Municipal Advisory Council
MBE Minority Business Enterprise
M.D. Medical Doctor
M.F.T. Marriage and Family Therapist
MIS Management Information System
MOE Maintenance of Effort
MOU Memorandum of Understanding
MTC Metropolitan Transportation Commission
NACo National Association of Counties
NEPA National Environmental Policy Act
OB-GYN Obstetrics and Gynecology
O.D. Doctor of Optometry
OES-EOC Office of Emergency Services-Emergency Operations Center
OPEB Other Post Employment Benefits
OSHA Occupational Safety and Health Administration
PARS Public Agencies Retirement Services
PEPRA Public Employees Pension Reform Act
Psy.D. Doctor of Psychology
RDA Redevelopment Agency
RFI Request For Information
RFP Request For Proposal
RFQ Request For Qualifications
RN Registered Nurse
SB Senate Bill
SBE Small Business Enterprise
SEIU Service Employees International Union
SUASI Super Urban Area Security Initiative
SWAT Southwest Area Transportation Committee
TRANSPAC Transportation Partnership & Cooperation (Central)
TRANSPLAN Transportation Planning Committee (East County)
TRE or **TTE** Trustee
TWIC Transportation, Water and Infrastructure Committee
UASI Urban Area Security Initiative
VA Department of Veterans Affairs
vs. versus (against)
WAN Wide Area Network
WBE Women Business Enterprise
WCCTAC West Contra Costa Transportation Advisory Committee



Contra
Costa
County

To: Board of Supervisors
From: Monica Nino, County Administrator
Date: March 8, 2022

Subject: Update on COVID -19

RECOMMENDATION(S):

ACCEPT update on COVID 19 and PROVIDE direction to staff.

FISCAL IMPACT:

Administrative Reports with no specific fiscal impact.

BACKGROUND:

The Health Services Department has established a website dedicated to COVID-19, including daily updates. The site is located at: <https://www.coronavirus.cchealth.org/>

APPROVE

OTHER

RECOMMENDATION OF CNTY ADMINISTRATOR

RECOMMENDATION OF BOARD COMMITTEE

Action of Board On: **03/08/2022** APPROVED AS RECOMMENDED OTHER

Clerks Notes:

VOTE OF SUPERVISORS

AYE: John Gioia, District I Supervisor
Candace Andersen, District II Supervisor
Diane Burgis, District III Supervisor
Karen Mitchoff, District IV Supervisor
Federal D. Glover, District V Supervisor

I hereby certify that this is a true and correct copy of an action taken and entered on the minutes of the Board of Supervisors on the date shown.

ATTESTED: March 8, 2022

Monica Nino, County Administrator and Clerk of the Board of Supervisors

By: June McHuen, Deputy

Contact: Monica Nino

cc:

CLERK'S ADDENDUM

Speakers: No Name Given; Caller 6770.

New cases of Covid-19 in Contra Costa County have dropped to 103 per day, a 33% decline from last week. Hospitalization is down to 61, a 25% decrease from last week. For comparison hospitalizations one month ago were at 235. Sadly, 96 patients passed away in January and 71 in February. The Omicron wave proved to more deadly than the Delta wave. More people had died during this past wave because so many people got Covid at the same time.

Masking requirements were relaxed in February in the County, in alignment with state guidelines. As of March 11, 2022, masking will no longer be required indoors at K-12 schools.

Director Roth notes in regard to the callers questions about C.28 C.30 and C.31, nursing contracts: all the nurses are licensed and credentialed in the United States. These items are all agency contracts, with today's action being an update to reflect rate increases. There is no change in the payment limit on them. .



Contra
Costa
County

To: Board of Supervisors
From: John Kopchik, Director, Conservation & Development Department
Date: March 8, 2022

Subject: Appeal of the County Planning Commission’s approval of a Tree Permit to build a new home at 144 Brodia Way in the unincorporated Walnut Creek

RECOMMENDATION(S):

1. OPEN the public hearing on an appeal of the County Planning Commission’s approval of a tree permit, RECEIVE testimony, and CLOSE the public hearing.
2. DETERMINE that the project is categorically exempt from the California Environmental Quality Act (CEQA), under CEQA Guidelines Section 15303(a) (new construction of one single-family residence).
3. DENY the appeal by Ezzat Akbari.
4. APPROVE a tree permit to work within the dripline of 11 code protected trees for the purpose of constructing a new single-family residence on a vacant lot located at 144 Brodia Way in the unincorporated Walnut Creek area (County File #CDTP21-00031).
5. APPROVE the attached findings and conditions of approval.
6. DIRECT the Department of Conservation and Development to file a Notice of Exemption with the County Clerk

FISCAL IMPACT:

None. The applicant is obligated to pay any additional costs beyond the initial deposit associated with processing the application.

APPROVE

OTHER

RECOMMENDATION OF CNTY ADMINISTRATOR

RECOMMENDATION OF BOARD COMMITTEE

Action of Board On: **03/08/2022** APPROVED AS RECOMMENDED OTHER

Clerks Notes:

VOTE OF SUPERVISORS

I hereby certify that this is a true and correct copy of an action taken and entered on the minutes of the Board of Supervisors on the date shown.

ATTESTED: March 8, 2022

Monica Nino, County Administrator and Clerk of the Board of Supervisors

Contact: Diana Lecca, 925-655-2868

By: , Deputy

cc:

BACKGROUND:

This is an appeal by a neighboring property owner of the County Planning Commission's (CPC) decision approving a tree permit to work within the dripline of eleven code protected trees in order to construct a new single-family residence on a vacant lot.

On May 27, 2021, the tree permit application was submitted to the Department of Conservation and Development, Current Planning Division. The proposal includes: construction of a 3,665 square-foot new residence, 190 cubic yards of fill, and 270 cubic yards of cut, and installation of site drainage. On July 27, 2021, a Notice of Tentative Approval of a tree permit was mailed to adjacent property owners and an appeal was received within the allowed amount of time.

APPEAL OF THE ZONING ADMINISTRATOR'S DECISION:

On August 4, 2021, one letter appealing the Zoning Administrator's decision was filed with the Department of Conservation and Development by Ezzat Akbari (neighbor) stating concerns regarding improper drainage from the proposed new residence.

Prior to submitting an application to the Department of Conservation and Development, the applicant for this project was made aware of drainage issues and instructed to begin the permitting process necessary to acquire a Drainage Permit from the Public Works Department. The applicant and owner of 144 Brodia Way has gone through the process with Public Works and received preliminary approval for Flood Control measures that will need to be installed. These provisions are to be updated and finalized once the Public Works Flood Control & Water Conservation District reviews the final plans.

Additionally, Planning staff reached out to the Department of Conservation and Development Grading staff to acquire further insight on potential issues pertaining to grading, drainage, and run-off. Grading staff reviewed the plans for the proposed new residence, and the proposed grading work and indicated no concerns regarding run-off. Grading staff also conducted a site visit to assess the property and ultimately indicated that the proposed natural channel would be an adequate alternative conveyance of run-off water generated within the site.

Staff included conditions of approval for the permit that, if approved, would require the applicant to comply with all County Flood Control and Water Conservation District requirements and provisions. On October 27, 2021, the County Planning Commission heard the publicly noticed appeal and voted unanimously to deny the appeal and uphold the Zoning Administrator's decision.

APPEAL OF THE PLANNING COMMISSION DECISION: One letter of appeal submitted by neighbor Ezzat Akbari was received by the Department of Conservation and Development on November 8, 2021.

Summary of Appeal Point #1: The appellant reiterates the concern of potential excessive rainwater run-off originating from the subject property and other upstream parcels. Their concern lies with the run-off accumulation from these properties that may discharge onto the appellant's property and on the adjacent downstream property of 449 La Casa Via.

Staff Response: The concerns raised by the appellant pertaining to the project's drainage are typically reviewed and addressed by the Public Works Department. Public Works staff has reviewed the proposed drainage plan and has provided the applicant with minor comments and identified several items that are to be revised and finalized upon the submittal of final plans for a building permit. At this stage, Public Works staff has determined that the proposed measures are sufficient for mitigating potential run-off. The Planning Commission approved several conditions of approval to address potential runoff, including requiring the owner to obtain the necessary drainage permit and comply with flood control provisions. These conditions will ensure that potential flooding and runoff from the subject property are properly addressed and minimized.

Summary of Appeal Point #2: Permanent damage of the subject trees would cause land erosion and instability. The work under the dripline will create additional flooding conditions for the subject property, the appellant's property and the adjacent property downstream.

Staff Response: The work under the dripline which includes re-grading the channel to lead potential run-off into a proposed drainage inlet has been reviewed by Public Works staff as well as Grading staff and found to be appropriate for this project. Planning staff also determined that in order to avoid working under the dripline of the trees, the house would have to be relocated to a southern portion of the property. Staff believes this relocation is not appropriate as additional grading to the property would need to be carried out which may cause additional drainage infrastructure to be installed. Additionally, the southern portion of the subject parcel has steeply sloped topography, thus creating difficult conditions for construction.

CONCLUSION

The appeal raises issues similar to those presented to the County Planning Commission. Staff believes that these issues were adequately addressed by the Planning Commission. The project is consistent with other residential development in the area. The project setting is not within an area where views or natural resources will be negatively impacted. Numerous conditions of approval have been added to this project which address concerns raised by the appellant. The proposed project, as conditioned, complies with the development standards as outlined in the County General Plan and R-40 Zoning District for this area of unincorporated Walnut Creek. Furthermore, all public agencies with responsibility for permitting of the project have reviewed the proposal and indicated that they had no concerns. Considering these facts, staff recommends that the Board of Supervisors deny the appeal and approve the tree permit, County File #CDTP21-00031.

CONSEQUENCE OF NEGATIVE ACTION:

If the appeal is granted, the tree permit would be denied.

CLERK'S ADDENDUM

Speakers: Appellant, Ezzat Akbari. Written correspondence received from Michael Rost, East Municipal Utility District; Appellant Ezzat Akbari (attached).

ATTACHMENTS

Appeal Letter

CDTP21-00031 Findings and Conditions

Additional Maps and Project Plans

CDTP21-00031 Presentation

From: Ezzat Akbari
124 Brodia Way
Walnut Creek, CA 94598

November 3, 2021

Re: Letter of Appeal of the County Planning Commission's decision on October 27, 2021 regarding the Tentative Approval of a Tree Permit (County File #CDTP21-00031)

To: Department of Conservation and Development
Community Development Division
30 Muir Road
Martinez, CA 94553
Attn: Diana Lecca

Dear Ms. Lecca,

This correspondence is a Letter of Appeal of the County Planning Commission's decision on October 27, 2021 regarding the Tentative Approval for a Tree Permit (County File #CDTP21-00031) for 144 Brodia Way in unincorporated area of Walnut Creek (APN 140-180-009).

There is a misunderstanding regarding the nature of the flooding concern for 144 Brodia Way. Per CPC Staff Report, Department of Conservation and Development Grading staff "*indicated that the proposed natural channel will be an adequate conveyance of run-off water generated within the site.*" The proposed drainage plan for County File #CDTP21-00031 focuses on addressing run-off water generated within 144 Brodia Way. It does not recognize the primary flooding concern is caused by storm water of far greater volume and velocity coming from upstream properties (as 25 years of experience living onsite has demonstrated). This storm water has not been controlled, contained, or regulated in an effective manner by existing drainage paths in 154 and 144 Brodia Way leading to flooding of 144 and 124 Brodia Way.

The drainage plan DP402-21 proposes to remove the existing 36" storm drain line in 144 Brodia Way. Instead, upstream storm water is intended to be diverted onto an inadequate carved-out and graded drainage channel running closer to Brodia Way (in violation of County Code 914-2.004, discussed below), leading to less not more control and containment of the upstream storm water. This is under the pretext that the existing 36" storm drain line is unpermitted and does not follow the path of the original natural drainage channel. I have the permit for this 36" storm drain line issued to a prior owner of the property. Both 124 and 144 Brodia Way had the same owner at the time the permit was issued (June 1974). The permit shows the 36" storm drain line clearly follows the path of the original natural drainage channel. The greater concern is ensuring all upstream storm water does indeed flow into this 36" line at the inlet on 144 Brodia Way. Removing the 36" line as proposed in DP 402-21 to build a home directly

in the path of an incoming flood will have disastrous consequences for both 144 and 124 Brodia Way. A flood will not take the detour onto the channel. I will not accept the flow of surface waters from 144 Brodia Way onto 124 Brodia Way as a result of diversion of storm water by the inadequate and ineffective storm drainage plan proposed in DP 402-21.

Under Code section 914-2.004(a), the proposed drainage plan DP402-21 qualifies for the following factors for denial:

All surface waters flowing from the subdivision in any form or manner shall be collected and conveyed without diversion or damage to any improvement, building or dwelling to a natural watercourse having definable bed and banks, or to an existing public storm drainage facility having adequate capacity to its point of discharge into a natural watercourse, or the advisory agency, in its discretion, may require that flows from the subdivision be regulated so as not to exceed the capacity of watercourses downstream when considered with regard to the development potential of the drainage basin or watershed. The existing proposal for 144 Brodia Way is attempting to divert surface water by changing the grading of the property to avoid damage to buildings or dwellings on 144 and 124 Brodia Way. In addition flows from 144 Brodia Way have already exceeded the capacity of watercourses downstream during flooding incidents, in violation of 914-2.004(a).

Under Code section 816-6.8010, the trees qualify for the following factors for denial:

(3) (B) - *It is reasonably likely that alteration or removal of the tree will cause problems with drainage, erosion control, land stability, windscreen, visual screening, and/or privacy and said problems cannot be mitigated as part of the proposed removal of the tree.* The new channel within the drip line of the trees will lead to drainage problems, substantial erosion, and land stability concerns for the pavement of Brodia Way and downstream properties. The volume and velocity of storm water entering 144 and 124 Brodia Way from upstream properties has already led to flooding and land instability in the past. Land instability will lead to impairment of Brodia Way, a private road with no substantial substructure. Attempting to divert flood water away from the building site towards the trees will lead to additional new drainage and land stability concerns without addressing existing problems.

(3) (E) - *If the permit involves trenching or grading and there are other reasonable alternatives including an alternate route, use of retaining walls, use of pier and grade beam foundations and/or relocating site improvements.* The proposed drainage plan focuses on run-off water generated within the site and does not acknowledge the primary flooding concern from storm water entering the property from upstream properties. There are reasonable alternatives to the trenching and grading in the proposed project. For example, there is no need to relocate the proposed site of the residence if the existing 36" storm drain line is removed (as already proposed) and replaced with a concrete storm drain line of comparable or greater drainage capacity. This concrete line also needs to be extended to the existing line emerging from

upstream developments to control and contain upstream storm water. Other developments in the neighborhood are already constructed with this type of drainage. There also needs to be regulation of the flow of upstream storm water to prevent overflow and flooding in both 144 Brodia Way and 449 La Casa Via.

(3) (F) - *Any other reasonable and relevant factors specified by the director.* The proposed grading attempts to divert upstream storm water and increases flooding risk for 124 Brodia Way. It also puts the building site on 144 Brodia Way at risk of flooding. 144 Brodia Way has a history of flooding caused by storm water from upstream properties and the proposed drainage plan only increases the flooding risk.

Respectfully yours,

Ezzat Akbari



UNITED STATES
POSTAL SERVICE®

POSTAL MONEY ORDER

Serial Number
27615500921

U.S. Dollars and Cents
\$250.00
Two Hundred Fifty Dollars and 00/100 *****

942960100

Pay to
Contra Costa County
30 Muir Road

From
Ezzat Akbar

Clerk 04

Address
Martinez, CA 94553
Memo For Appeal #CDT p.21

Address
124 Brodia Way
Walnut Creek, CA 94598



POSTNET
:00000080021

SEE REVERSE WARNING - NEGOTIABLE ONLY IN THE U.S. AND POSSESSIONS
27615500921

**FINDINGS AND CONDITIONS OF APPROVAL FOR COUNTY FILE #CDTP21-00031;
PATRICK VAUCHERET (APPLICANT) & MANGALPAL TAKHAR AND SONYA SACHDEVA
(PROPERTY OWNERS):**

I. FINDINGS

A. Required Factors for Granting Permit. The County Board of Supervisors is satisfied that the following factors as provided by County Code Section 816-6.8010 for granting a Tree Permit have been satisfied as follows:

- Development to construct a new single-family residence and driveway on a vacant lot requires work to be done in the dripline of eleven code-protected trees, and this development could not be reasonably accommodated on another area of the lot.

B. Required Factors for Denying a Tree Permit. The County Board of Supervisors is satisfied that none of the factors as provided by County Code Section 816-6.8010 for denying (or modifying) a tree permit application apply to the subject property.

C. California Environmental Quality Act (CEQA). The project is exempt under CEQA: Categorical Exemption – Class 3: CEQA Guidelines Section 15303, New Construction or Conversion of Small Structures, (a) One single-family residence. Given that the project is to build a new single-family residence with associated grading and to retain the site’s existing trees, granting of an exemption to CEQA is appropriate for the project as proposed.

II. CONDITIONS OF APPROVAL FOR COUNTY FILE #CDTP21-00031:

Project Approval

1. This application for a Tree Permit to allow work within the dripline of 11 code protected trees—ten Pine trees of sizes ranging between 8”–16” in diameter, and one Oak tree of 10” in diameter—on a vacant lot for the construction of a new single-family residence, including grading of 190 cubic yards of cut, and 270 cubic yards of fill, is hereby APPROVED.
2. This application for a Tree Permit is approved based on the following documents:
 - Application documents submitted on May 27, 2021;
 - Updated Site Plan received on July 15, 2021.

3. Any changes to the approved plans stated above must be submitted for review and approval by CDD and may require the filing of a new application.
4. Code-protected trees that are not included under this permit shall not be removed or altered. Proposed removal or alteration of a tree or trees not identified in this permit may require the submittal of a Tree Permit application for review and consideration by CDD.

Payment of Fees

5. This Tree Permit application was subject to an initial deposit of \$2,000.00. The application is subject to time and material costs if the application review expenses exceed the initial deposit. **Any additional fee due must be paid prior to submittal of a building permit, or 60 days of the effective date of this permit, whichever occurs first.** The fees include costs through permit issuance and final file preparation. Pursuant to Contra Costa County Board of Supervisors Resolution Number 2019/553, where a fee payment is over 60 days past due, the Department of Conservation and Development may seek a court judgement against the applicant and will charge interest at a rate of ten percent (10%) from the date of judgement. The applicant may obtain current costs by contacting the project planner.

Park Impact Fee

6. Prior to the issuance of building permits, the applicant shall pay a fee of \$8,292.00 for construction of a single-family detached on a vacant parcel for park and recreation improvements in the area as established by the Board of Supervisors; however, the actual fee amount collected shall be that which is applicable at the time of building permit issuance.

Security for Possible Damage to Tree Intended for Preservation:

7. Pursuant to the requirements of Section 816-6.1204 of the Tree Protection and Preservation Ordinance, to address the possibility that construction activity damages trees that are to be preserved, the applicant shall provide the County with a security to allow for replacement of trees that are significantly damaged or destroyed by construction activity. **Prior to submitting for building permits**, the applicant shall provide a cash or surety bond that is acceptable to the CDD.
 - A. Amount of Security: The security shall be an amount sufficient to cover:

1. Preparation of a landscaping and irrigation plan by a licensed landscape architect, arborist, or landscape contractor for the review and approval of the CDD. The plan shall provide for planting of up to **11** trees of a native indigenous species, of 15-gallons in size. The plan shall comply with the State's Model Water Efficient Landscape Ordinance, and verification of such shall accompany the plan. **If deemed necessary by the CDD, the plan shall be implemented prior to final building inspection.**
 2. The estimated materials and labor costs to complete the improvements shown on the approved planting and irrigation plan (accounting for supply, delivery, and installation of trees and irrigation).
 3. The bond shall include the amount of the approved cost estimate, plus a 20% inflation surcharge.
- B. Initial Deposit for Processing of Security: The County ordinance requires that the applicant pay fees to cover all staff time and material costs for processing the required security. At the time of submittal of the security, the applicant shall pay an initial deposit of \$200.00.
- C. Duration of Security: The security shall be retained by the County for a minimum of 12 months and up to 24 months beyond the completion of the tree alteration improvements (i.e., date of final inspection). After the final inspection has been completed, the applicant shall submit a letter to the CDD, composed by a consulting arborist, describing any construction impacts to trees intended for preservation. As a prerequisite of releasing the bond between 12- and 24-months, the applicant shall arrange for the consulting arborist to inspect the trees and to prepare a report on the trees' health. The report shall be submitted to the CDD for review, and it shall include any additional measures necessary for preserving the health of the trees.

Arborist Expense

8. The expenses associated with all required arborist services shall be borne by the applicant and/or property owner.

Drainage Improvement

9. Applicant shall collect and convey all stormwater entering and/or originating on this property, without diversion and within an adequate storm drainage system, to an adequate natural watercourse having definable bed and banks, or to an existing adequate public storm drainage system which conveys the stormwater to an

adequate natural watercourse, in accordance with Division 914 of the Ordinance Code.

10. **Prior to issuance of a Building Permit**, the applicant shall provide to the Public Works Department, the finalized plans addressing the drainage measures.
11. Applicant shall comply with the special provisions as established in Drainage Permit #DP 402-21.

Construction Period Requirements and Restrictions

12. Site Preparation: Prior to the start of construction or any clearing, stockpiling, trenching, grading, compaction, paving or change in ground elevation on site with the trees to be preserved, the Applicant shall install protective fencing at or beyond the drip lines of the trees to be preserved and along the boundaries of all other protected trees within the vicinity of construction. The fencing shall remain in place for the duration of construction activities. Prior to grading or issuance of any permits, the fences may be inspected, and the location thereof approved by the Building Inspection Division or Community Development Division staff. *Construction plans shall stipulate on their face where temporary fencing is to be placed. The required fencing shall be installed prior to the commencement of any construction activity and left in place until construction activities have been resumed.*

Archeology

13. If archaeological materials are uncovered during grading, trenching, or other onsite excavation, all work within 30 yards of these materials shall be stopped until a professional archaeologist who is certified by the Society for California Archaeology (SCA) and/or the Society of Professional Archaeology (SOPA), and the Native American tribe that has requested consultation and/or demonstrated interest in the project site, have had an opportunity to evaluate the significance of the find and suggest appropriate mitigation(s) if deemed necessary.
14. Should human remains be uncovered during grading, trenching, or other on-site excavation(s), earthwork within 30 yards of these materials shall be stopped until the County coroner has had an opportunity to evaluate the significance of the human remains and determine the proper treatment and disposition of the remains. Pursuant to California Health and Safety Code Section 7050.5, if the coroner determines the remains may those of a Native American, the coroner is responsible for contacting the Native American Heritage Commission (NAHC) by telephone within 24 hours. Pursuant to California Public Resources Code Section 5097.98, the NAHC will then determine a Most Likely Descendant (MLD) tribe and contact them. The MLD tribe has 48 hours from the time they are given access to the site to make

recommendations to the landowner for treatment and disposition of the ancestor's remains. The landowner shall follow the requirements of Public Resources Code Section 5097.98 for the remains.

Landscaping

15. If any landscaping is proposed to be installed during construction of the approved project that equals 2,500 square-feet or more, prior to issuance of a building permit a Compliance Review application shall be submitted and approved that shows compliancy with the State's Model Water Efficient Landscape Ordinance (WELO).

Construction Period Restrictions and Requirements Best Management Practices (BMPs)

The following Best Management Practices shall be implemented during project construction and **shall be present on the site plan for building permit(s) as construction notes:**

16. The applicant shall comply with the following restrictions and requirements:

Construction activities shall be limited to the hours of 8:00 A.M. to 5:00 P.M., Monday through Friday, and are prohibited on state and federal holidays on the calendar dates that these holidays are observed by the state or federal government as listed below:

- New Year's Day (State and Federal)
- Birthday of Martin Luther King, Jr. (State and Federal)
- Washington's Birthday (Federal)
- Lincoln's Birthday (State)
- President's Day (State and Federal)
- Cesar Chavez Day (State)
- Memorial Day (State and Federal)
- Independence Day (State and Federal)
- Labor Day (State and Federal)
- Columbus Day (State and Federal)
- Veterans Day (State and Federal)
- Thanksgiving Day (State and Federal)
- Day after Thanksgiving (State)
- Christmas Day (State and Federal)

For information on the actual days and dates that these holidays occur, please visit the following websites:

Federal: <http://www.federalreserve.gov/aboutthefed/k8.htm>

State: <http://www.sos.ca.gov/holidays.htm>

17. The project sponsor shall require their contractors and subcontractors to fit all internal combustion engines with mufflers which are in good condition and shall locate stationary noise-generating equipment such as air compressors and concrete pumps as far away from sensitive receptors as possible.
18. The applicant shall make a good-faith effort to avoid interference with existing neighborhood traffic flows.
19. Transporting of heavy equipment and trucks shall be limited to the hours of 9:00 A.M. to 4:00 P.M., Monday through Friday, and is prohibited on state and federal holidays.
20. Unnecessary idling of internal combustion engines is prohibited.
21. The site shall be maintained in an orderly fashion. Following the cessation of construction activity, all debris shall be removed from the site.
22. The applicant shall immediately notify the CDD of any damage that occurs to any trees during the construction process. Any tree not approved for destruction or removal that dies or is significantly damaged as a result of construction or grading shall be replaced with a tree or trees of equivalent size and of a species as approved by the CDD to be reasonably appropriate for the particular situation.
23. No parking or storage of vehicles, equipment, machinery, or construction materials and no dumping of paints, oils, contaminated water, or any chemicals shall be permitted within the drip line of any tree to be preserved.
24. No grading, compaction, stockpiling, trenching, paving, or change in ground elevation shall be permitted within the drip line of any tree intended for preservation unless such activities are indicated on the improvement plans approved by the CDD. If any of the activities listed above occur within the drip line of a tree to be preserved, an arborist may be required to be present. The arborist shall have the authority to require implementation of measures to protect the tree.

ADVISORY NOTES

ADVISORY NOTES ARE NOT CONDITIONS OF APPROVAL; THEY ARE PROVIDED TO ALERT THE APPLICANT TO ADDITIONAL ORDINANCES, STATUTES, AND LEGAL REQUIREMENTS OF THE COUNTY AND OTHER PUBLIC AGENCIES THAT MAY BE APPLICABLE TO THIS PROJECT.

- A. NOTICE OF OPPORTUNITY TO PROTEST FEES, ASSESSMENTS, DEDICATIONS, RESERVATIONS OR OTHER EXACTIONS PERTAINING TO THE APPROVAL OF THIS PERMIT.

Pursuant to California Government Code Section 66000, et seq., the applicant has the opportunity to protest fees, dedications, reservations or exactions required as part of this project approval. To be valid, a protest must be in writing pursuant to Government Code Section 66020 and must be delivered to the Community Development Division within a 90-day period that begins on the date that this project is approved. If the 90th day falls on a day that the Community Development Division is closed, then the protest must be submitted by the end of the next business day.

- B. Additional requirements may be imposed by the following agencies:
- Contra Costa County Building Inspection Division
 - Contra Costa County Grading Division
 - Contra Costa County Public Works Division
 - Contra Costa County Fire Protection District
 - Central Contra Costa Sanitary District
 - East Bay Municipal Utility District



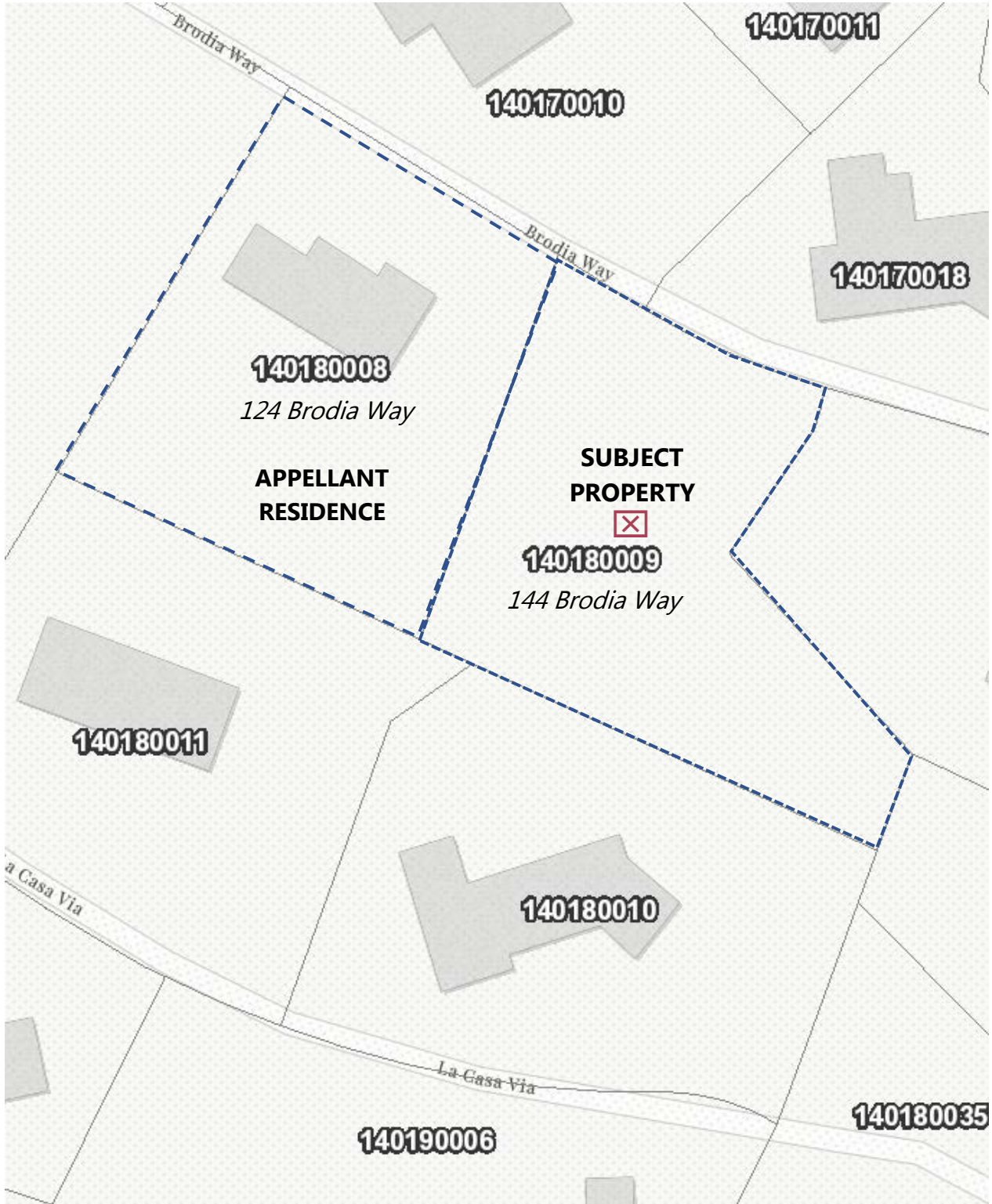



ATTACHMENT A



Appellant residence in relation to the Applicant/Owner residence



Legend

-  Board of Supervisors' Districts
-  City Limits
- Unincorporated
-  Address Points
-  Streets
-  Building Outlines
-  Assessment Parcels
- World Imagery
- Low Resolution 15m Imagery
- High Resolution 60cm Imagery
- High Resolution 30cm Imagery
- Citations

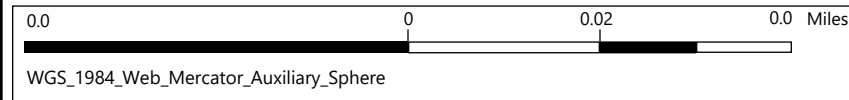

This map is a user generated static output from an Internet mapping site and is for reference only. Data layers that appear on this map may or may not be accurate, current, or otherwise reliable.
THIS MAP IS NOT TO BE USED FOR NAVIGATION

1: 1,128



Notes

Zoning Map



Legend

- Board of Supervisors' Districts
- City Limits
- Unincorporated**
- Zoning**
- R-6 (Single Family Residential)
- R-6, -FH -UE (Flood Hazard and A
- R-6 -SD-1 (Slope Density Hillside E
- R-6 -TOV -K (Tree Obstruction anc
- R-6, -UE (Urban Farm Animal Excl
- R-6 -X (Railroad Corridor Combinir
- R-7 (Single Family Residential)
- R-7 -X (Railroad Corridor Combinin
- R-10 (Single Family Residential)
- R-10, -UE (Urban Farm Animal Exc
- R-12 (Single Family Residential)
- R-15 (Single Family Residential)
- R-20 (Single Family Residential)
- R-20, -UE (Urban Farm Animal Exc
- R-40 (Single Family Residential)
- R-40, -FH -UE (Flood Hazard and A
- R-40, -UE (Urban Farm Animal Exc
- R-65 (Single Family Residential)
- R-100 (Single Family Residential)
- D-1 (Two Family Residential)
- D-1 -T (Transitional Combining Dist
- D-1, -UE (Urban Farm Animal Excl
- M-12 (Multiple Family Residential)
- M-12 -FH (Flood Hazard Combining
- M-17 (Multiple Family Residential)
- M-29 (Multiple Family Residential)
- F-R (Forestry Recreational)
- F-R -FH (Flood Hazard Combining I
- F-1 (Water Recreational)
- F-1 -FH (Flood Hazard Combining I
- A-2 (General Agriculture)
- A-2, -BS (Boat Storage Combining I
- A-2, -BS -SG (Boat Storage and So
- A-2 -FH (Flood Hazard Combining I
- A-2, -FH -SG (Flood Hazard and Sc

1: 1,128



0.0 0 0.02 0.0 Miles

WGS_1984_Web_Mercator_Auxiliary_Sphere

This map is a user generated static output from an Internet mapping site and is for reference only. Data layers that appear on this map may or may not be accurate, current, or otherwise reliable.

THIS MAP IS NOT TO BE USED FOR NAVIGATION

Notes

General Plan Map



Legend

- Board of Supervisors' Districts
- City Limits
- Unincorporated
- General Plan
 - SV (Single Family Residential - Ver
 - SL (Single Family Residential - Low
 - SM (Single Family Residential - Me
 - SH (Single Family Residential - Hig
 - ML (Multiple Family Residential - Lc
 - MM (Multiple Family Residential - M
 - MH (Multiple Family Residential - H
 - MV (Multiple Family Residential - V
 - MS (Multiple Family Residential - V
 - CC (Congregate Care/Senior Housi
 - MO (Mobile Home)
 - M-1 (Parker Avenue Mixed Use)
 - M-2 (Downtown/Waterfront Rodeo I
 - M-3 (Pleasant Hill BART Mixed Use
 - M-4 (Willow Pass Road Mixed Use)
 - M-5 (Willow Pass Road Commercia
 - M-6 (Bay Point Residential Mixed U
 - M-7 (Pittsburg/Bay Point BART Star
 - M-8 (Dougherty Valley Village Cent
 - M-9 (Montalvin Manor Mixed Use)
 - M-10 (Willow Pass Business Park M
 - M-11 (Appian Way Mixed Use)
 - M-12 (Triangle Area Mixed Use)
 - M-13 (San Pablo Dam Road Mixed
 - M-14 (Heritage Mixed Use)
 - CO (Commercial)
 - OF (Office)
 - BP (Business Park)
 - LI (Light Industry)
 - HI (Heavy Industry)
 - AL, OIBA (Agricultural Lands & Off
 - CR (Commercial Recreation)
 - ACO (Airport Commercial)
 - LF (Landfill)
 - PS (Public/Semi-Public)

1: 1,128



0.0 0 0.02 0.0 Miles

WGS_1984_Web_Mercator_Auxiliary_Sphere

This map is a user generated static output from an Internet mapping site and is for reference only. Data layers that appear on this map may or may not be accurate, current, or otherwise reliable.

THIS MAP IS NOT TO BE USED FOR NAVIGATION

Notes

- 1-1965- 30LSM41 10/15/64
- 2-1969- 36LSM26 8/4/65
- 3- 23PM11 7/19/72
- 4- 64PM44 4/12/78 REVERTING TO ACREAGE
- 5- 140PM45 6/22/89
- 6- 169PM9 5/14/96
- 7- 194PM50 10/25/05

RO SAN MIGUEL
NO. 4 HILL LAND

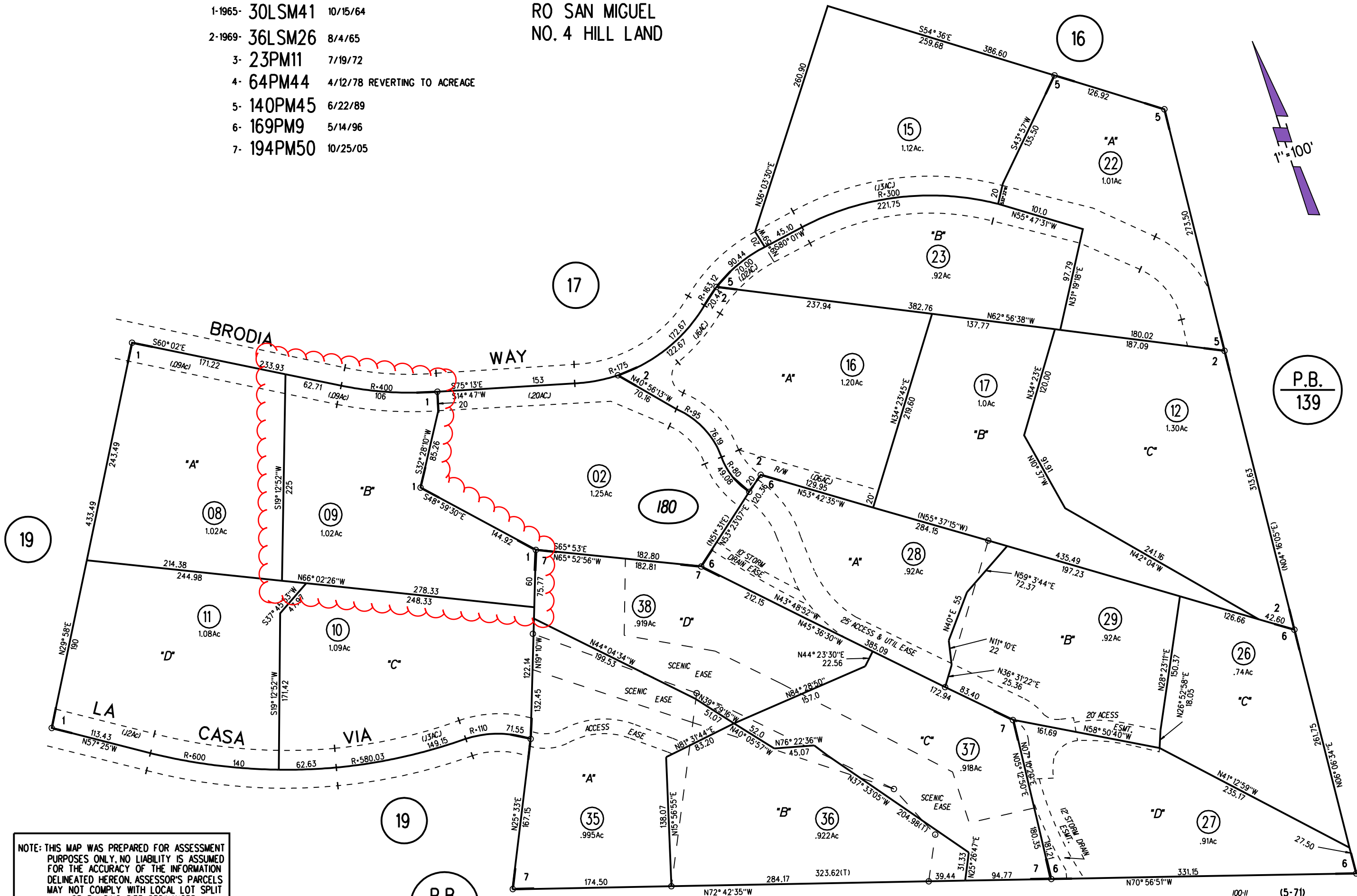

NOTE: THIS MAP WAS PREPARED FOR ASSESSMENT PURPOSES ONLY. NO LIABILITY IS ASSUMED FOR THE ACCURACY OF THE INFORMATION DELINEATED HEREON. ASSESSOR'S PARCELS MAY NOT COMPLY WITH LOCAL LOT SPLIT OR BUILDING SITE ORDINANCES.

P.B.
180

180 38
3/12/08

100-11 (5-71)
ASSESSOR'S MAP
BOOK 140 PAGE 18
CONTRA COSTA COUNTY, CALIF.

ADDRESS

144 Brodia Way
Walnut Creek, CA 94598

DRAINAGE PERMIT PENDING

Planning Application contingent
on Drainage Permit DP 402-21.
Department: Contra Costa
County Flood Control

PROJECT TEAM

Owner:
MangalPal Takhar and
Sonya Sachdeva
1 408 421 1641

Applicant/Designer:
CITE I DESIGNS/Patrick Vaucheret
214 Whitney Ct
Walnut Creek, CA 94598
1 415 637 6207

Civil Engineer:
Design Resource Inc.
3021 Citrus Circle Ste 150
Walnut Creek, CA 94598
1 925 210 9300

Structural Engineer:
Teal Engineering Inc./Ron Teal
1 925 212-0767

CODE COMPLIANCE

All Construction Shall Conform to:
2019 CALIFORNIA BUILDING CODE CBC
2019 CALIFORNIA RESIDENTIAL CODE CRC
2019 CALIFORNIA PLUMBING CODE CPC
2019 CALIFORNIA MECHANICAL CODE CMC
2019 CALIFORNIA ELECTRICAL CODE CEC
2019 CALIFORNIA REFERENCED STANDARDS
CODE
2019 CALIFORNIA ENERGY CODE
2019 CGBC - CALIFORNIA GREEN BUILDINGS
CODE
2019 CALIFORNIA FIRE CODE

PROJECT

APN 140-180-009
Parcel Area 44,431 sq. ft.
Zoning R-40
Building Height 2.5 Stories/35' max.
Coverage 50% max.
ADU up to 2 units

Setbacks minimum
Front 25'
Side 20'-40' aggregated
Rear 15'

Parking 2 space per unit 9ft x 19ft

RECEIVED on 05/27/2021 CDT21-00031
By Contra Costa County
Department of Conservation and Development

CITE I DESIGNS



CITE I DESIGNS
Patrick Vaucheret
214 Whitney Ct
Walnut Creek, CA 94598
1 415 637 6207

Owner:
Mangalpal Takhar and
Sonya Sachdeva

VICINITY MAP

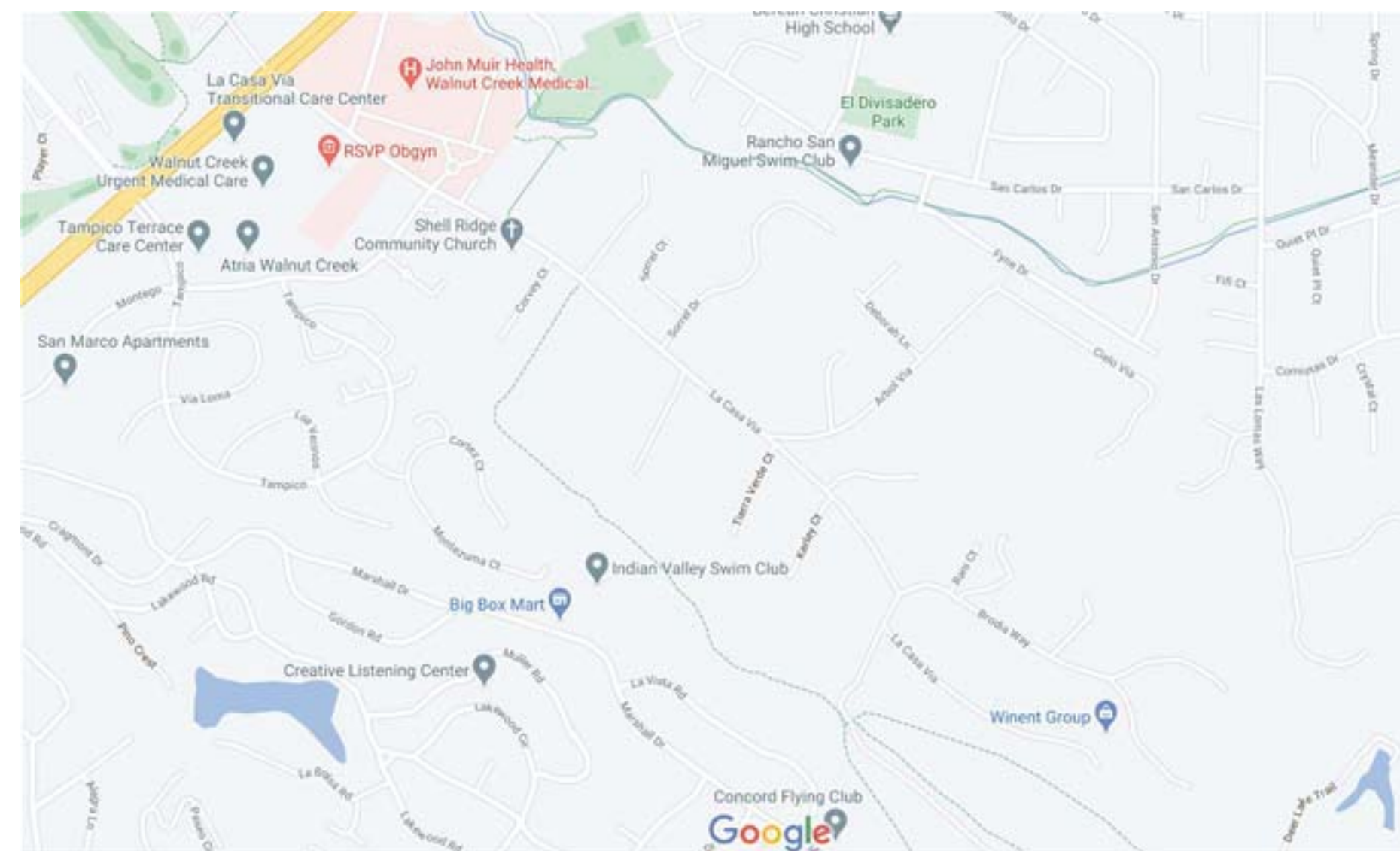

GRAPHIC SYMBOLS

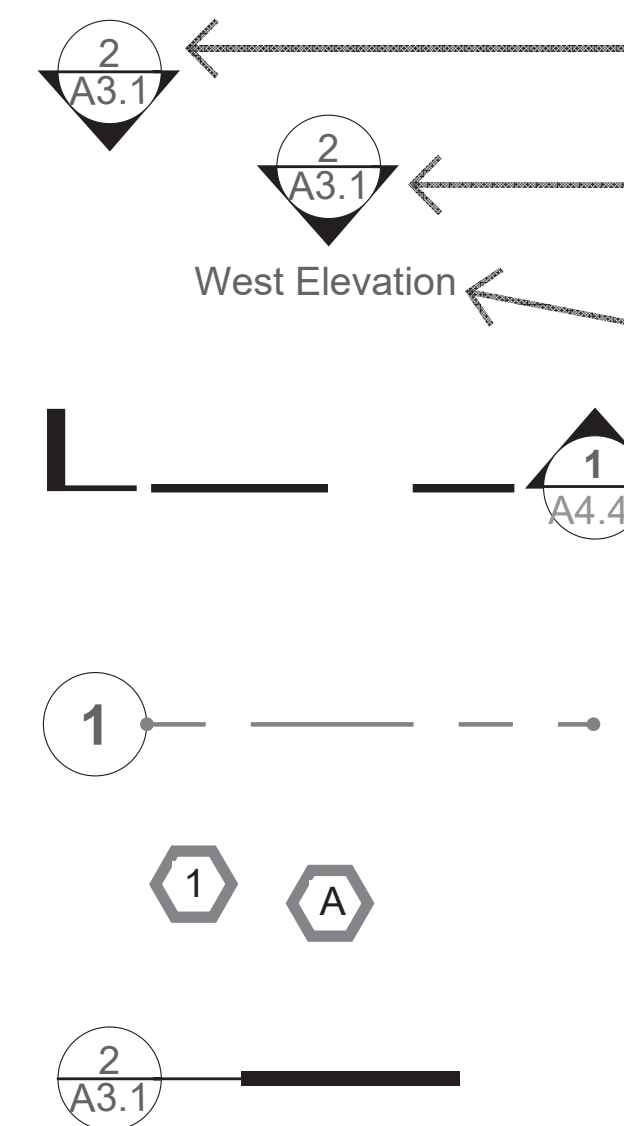

View number

Sheet number

View title

Section line/orientation

Grid line and number

Window/Door tag

Detail tag

PROJECT PARCEL

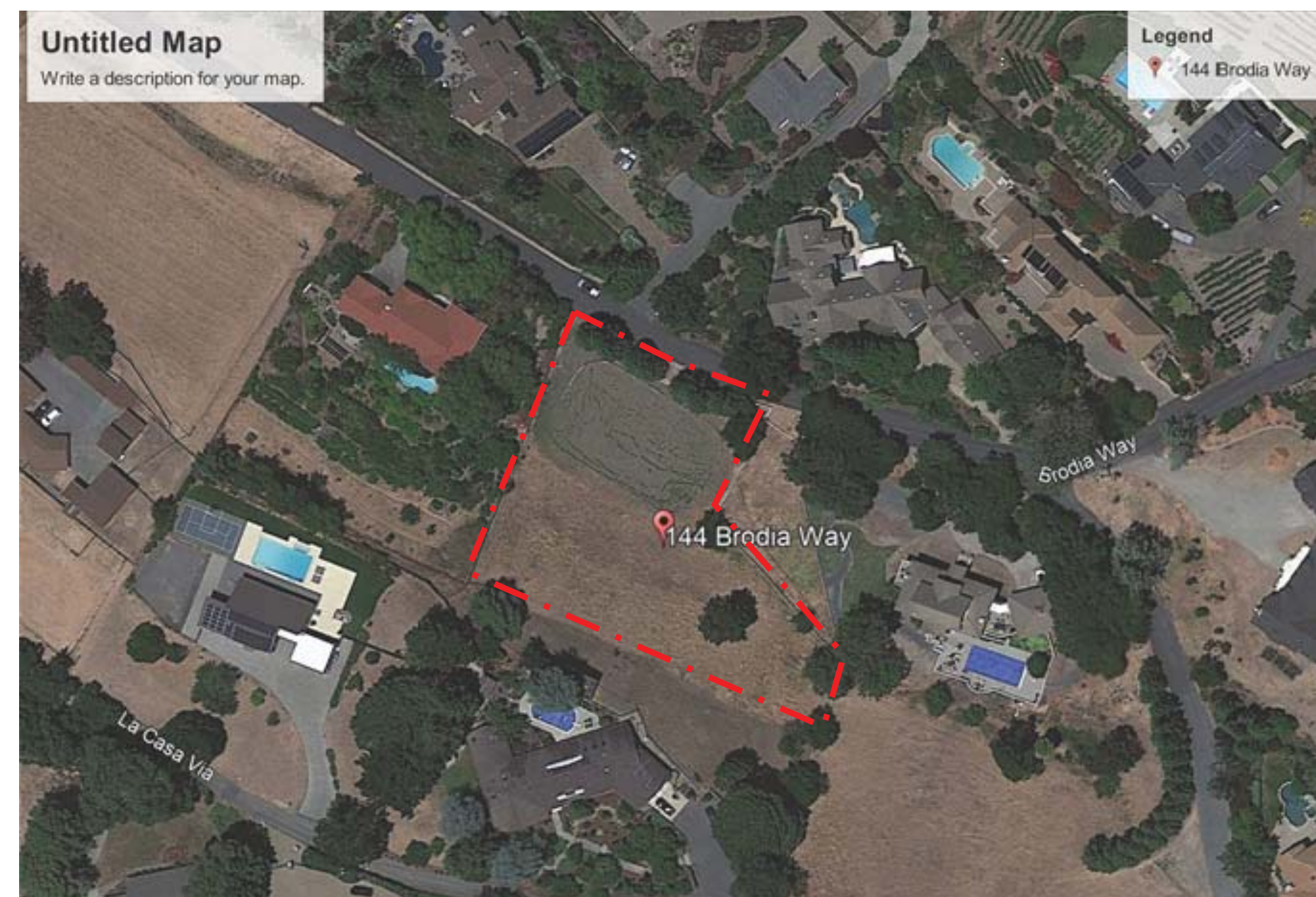

PROJECT OVERVIEW



Proposed

Building Height 2 stories/ 27'
First Floor Area 2,275 sq. ft.
Second Floor Area 1,390sq. ft.
Total Floor Area 3,665 sq. ft.

Garage 705 sq. ft.
Parking Spaces 3 car garage
(including 2 standard spaces 9ft x 19ft)
Impervious area 5,806 sq. ft.

Solar Panels 3.6 to 4KW System

SHEETS INDEX

A0.0	Cover
TS	Topographic Survey
GP	Grading Plan Sheet 1 & Sheet2
A1.1	Existing Context Site Plan
A1.2	Context Site Plan
A1.3	Detailed Site Plan
A2.1	First Floor Plan
A2.2	Second Floor Plan
A2.3	Roof Plan
A4.1	Elevations and Materials
A4.2	Elevations and Materials
A5.1	Sections
A6.1	Exterior Materials Samples
A7.1	Perspectives

BRODIA WAY RESIDENCE

144 Brodia Way
WALNUT CREEK, CA

Contra Costa County
Dept. of Conservation
and Development
Community Development
Division

Planning Application
20 APRIL 2021

COVER

A0.0

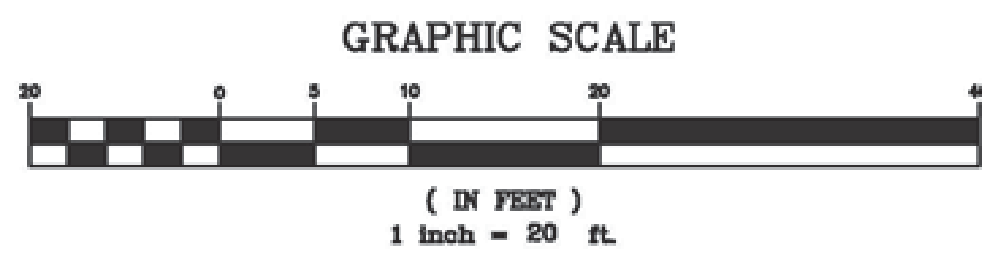
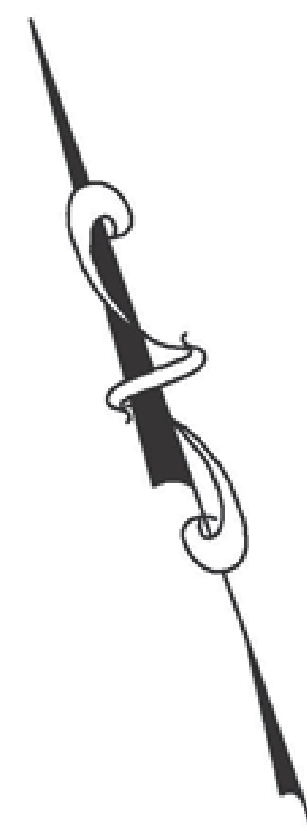

READ & ACKNOWLEDGED
Pg.01

Buyer _____
 Date _____
 Buyer _____
 Date _____

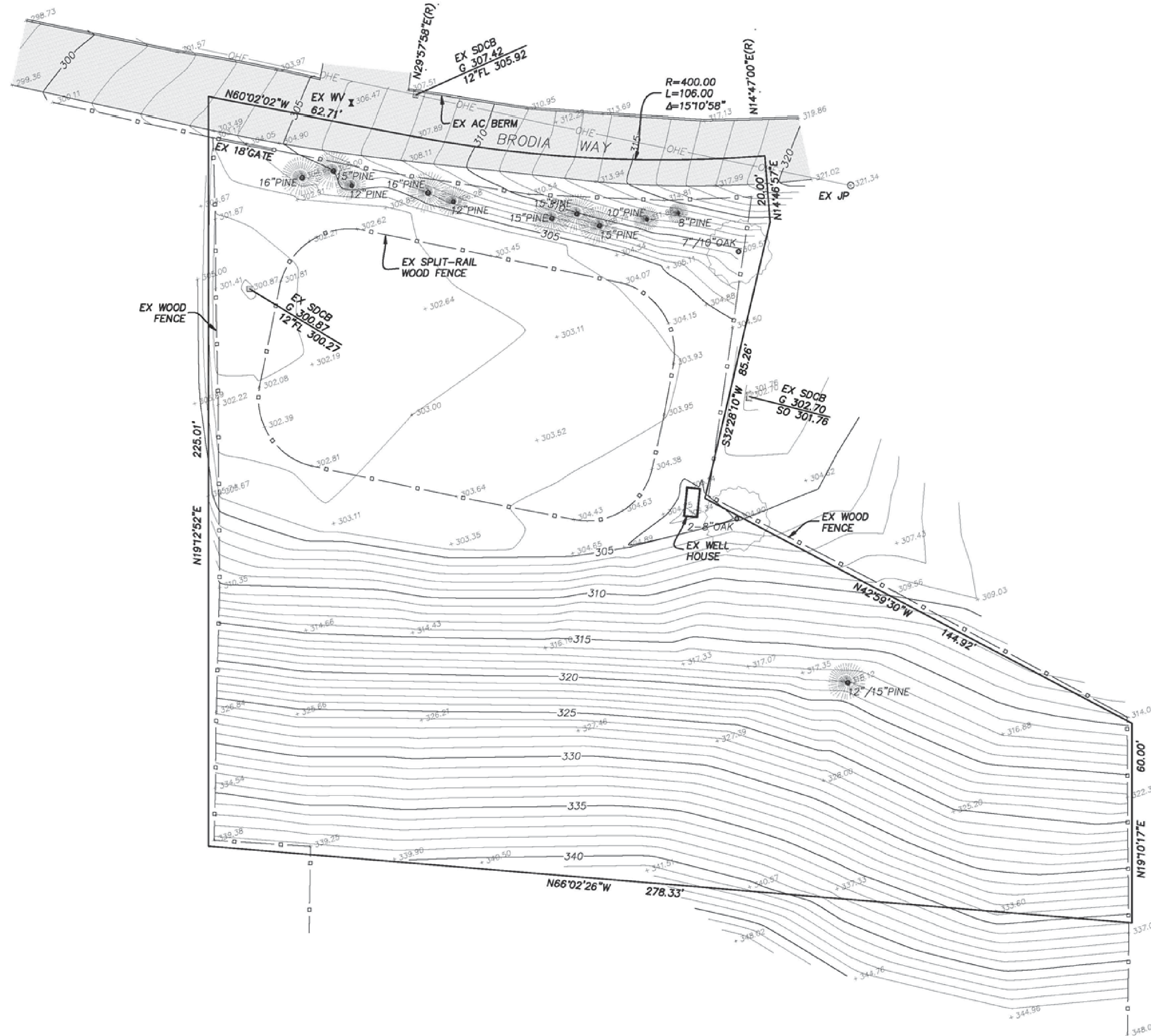

EX SSMH
 RIM 341.87
 FL 330.17

DATE: 2/6/2017
 SCALE: AS SHOWN
 DESIGNED BY:
 DRAWN BY: RF
 CHECKED BY: GM



No.	DATE	APVD.	REVISION

TERRA FIRMA
 ENGINEERING-SURVEYING-LAND PLANNING
 GOLF COURSE DESIGN
 3710 LONE TREE WAY #113, ANTIOCH, CA. 94509
 PH: 925-437-3700



WALNUT CREEK

TOPOGRAPHIC SURVEY
144 BRODIA WAY
 CONTRA COSTA COUNTY

CALIFORNIA

SHEET
 1
 OF 1 SHEETS
 PROJECT NO.
 1654

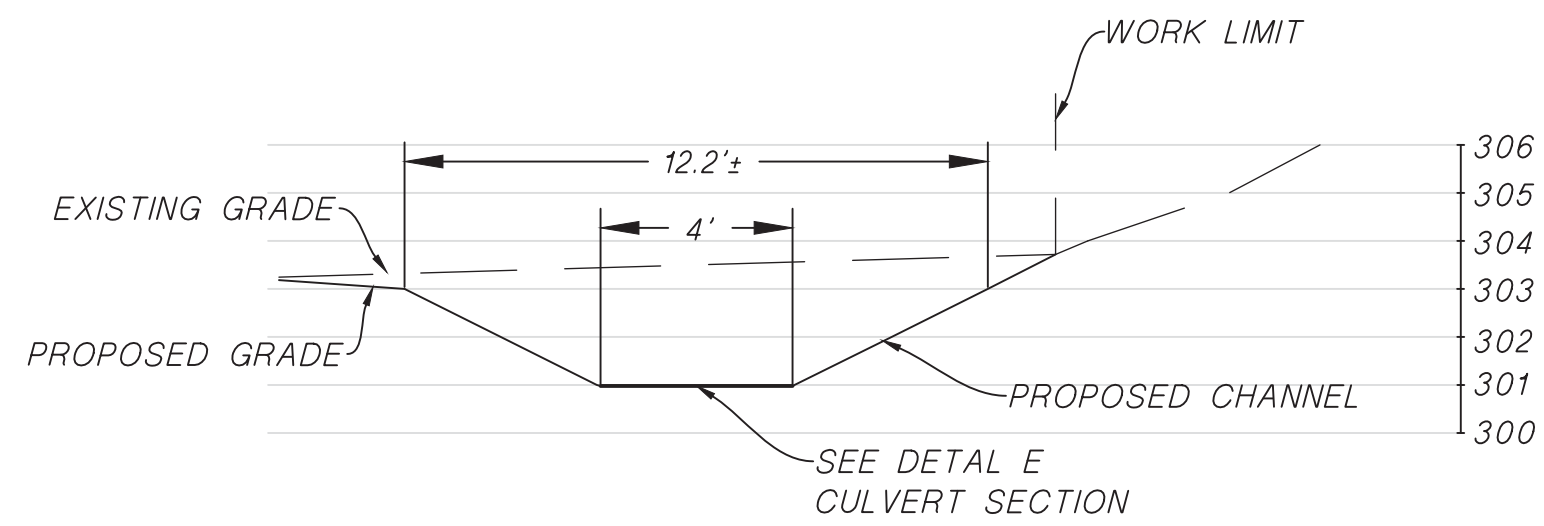

SECTION A-A

HORI. 1"=4'
VERT. 1"=4'

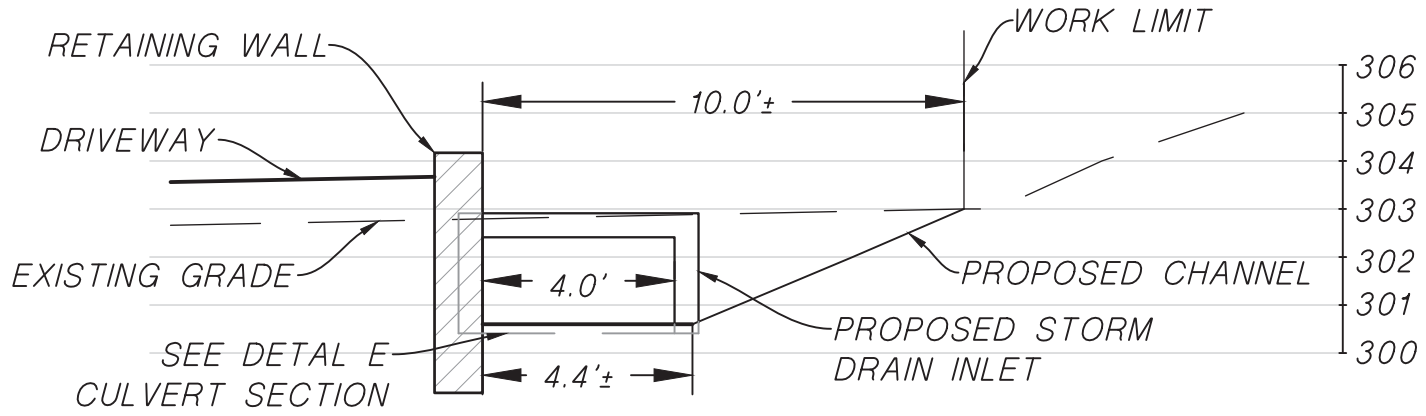

SECTION B-B

HORI. 1"=4'
VERT. 1"=4'

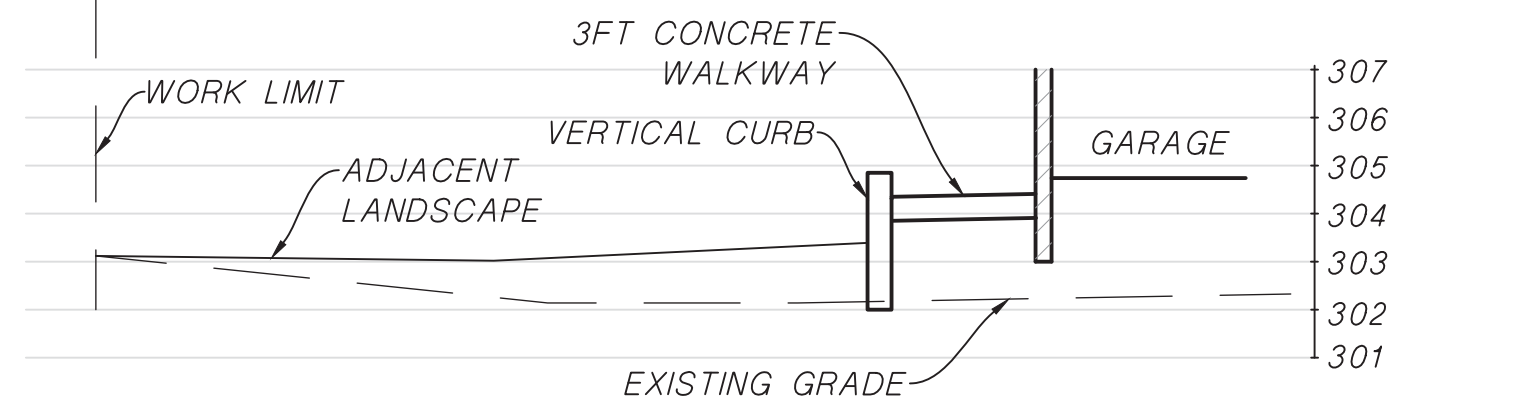

SECTION C-C

HORI. 1"=4'
VERT. 1"=4'

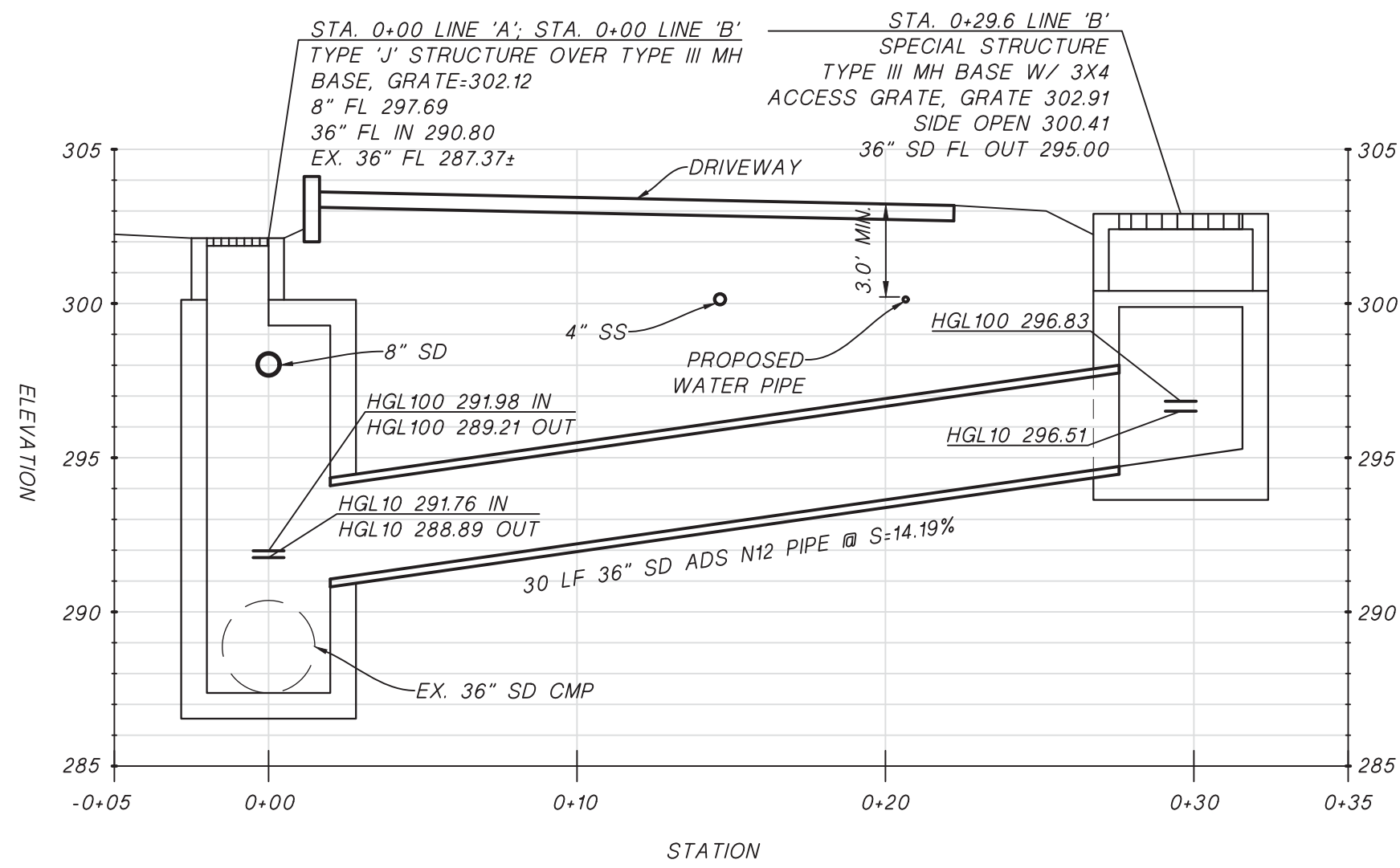

36" SD PROFILE D-D

HORI. 1"=5'
VERT. 1"=5'

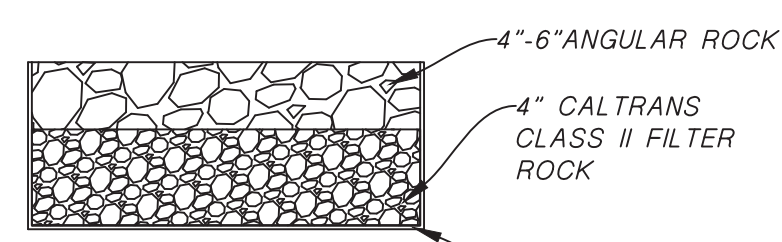

DETAIL E

CULVERT SECTION PER GEOTECH RECOMMENDATIONS
NOT TO SCALE

PRELIMINARY

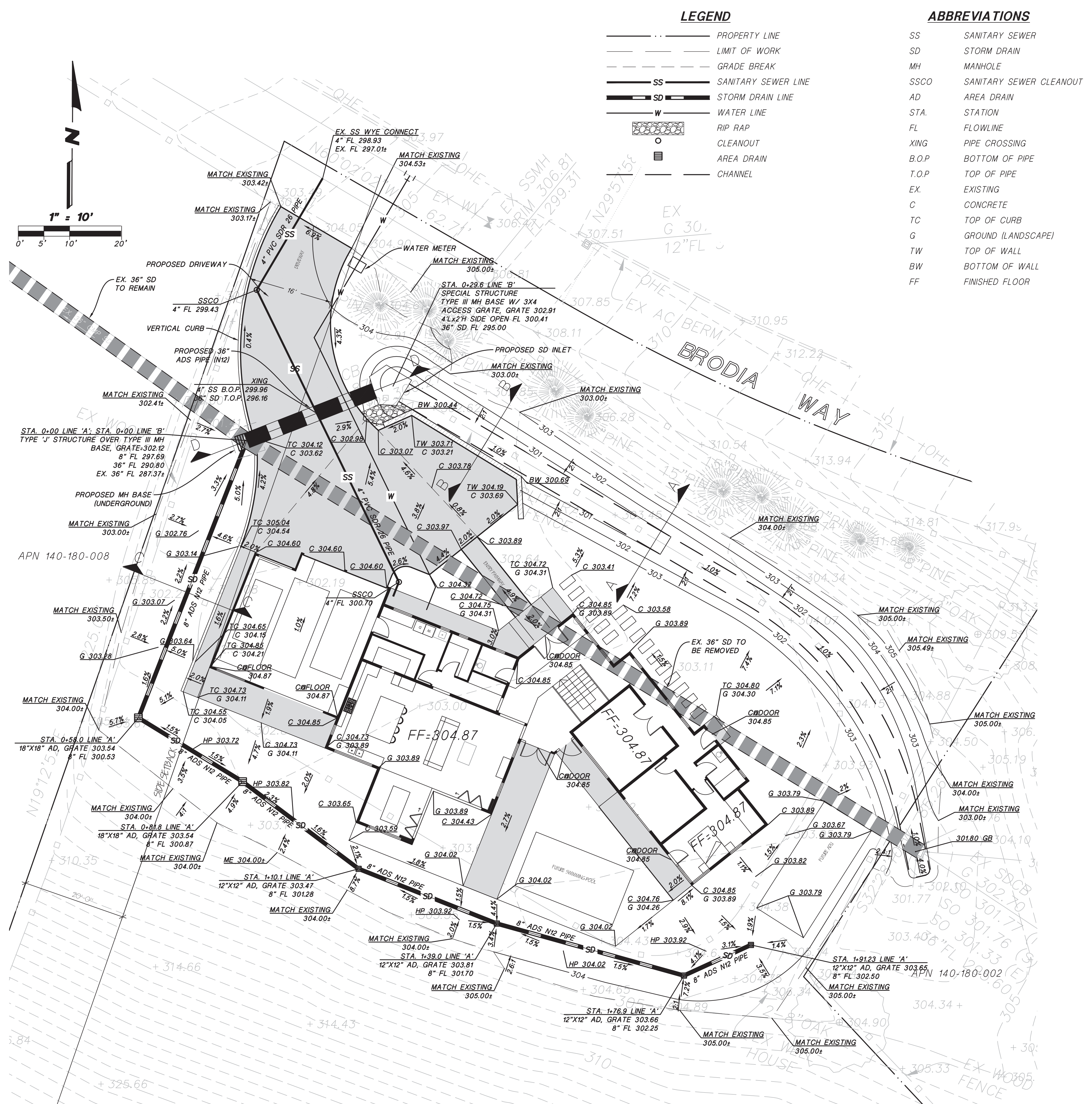

LEGEND

- PROPERTY LINE
- LIMIT OF WORK
- GRADE BREAK
- SS --- SANITARY SEWER LINE
- SD --- STORM DRAIN LINE
- W --- WATER LINE
- RIP RAP
- CLEANOUT
- ▣ AREA DRAIN
- CHANNEL

ABBREVIATIONS

- SS SANITARY SEWER
- SD STORM DRAIN
- MH MANHOLE
- SSCO SANITARY SEWER CLEANOUT
- AD AREA DRAIN
- STA. STATION
- FL FLOWLINE
- XING PIPE CROSSING
- B.O.P. BOTTOM OF PIPE
- T.O.P. TOP OF PIPE
- EX. EXISTING
- C CONCRETE
- TC TOP OF CURB
- G GROUND (LANDSCAPE)
- TW TOP OF WALL
- BW BOTTOM OF WALL
- FF FINISHED FLOOR

PA Design Resources, Inc.
 Planning ■ Engineering ■ Surveying
 3021 Citrus Circle, Suite 150
 Walnut Creek, California 94598-2635
 TEL (925) 210-9300

144 BRODIA WAY
 APN 140-180-009
CONCEPTUAL GRADING PLAN
 CALIFORNIA
 WALNUT CREEK

DATE: 04-28-2021
SCALE: HORIZ. 1"=10' VERT.
DESIGN: _____
CHECKED: _____
SHEET: 1
OF 2 SHEETS
PROJ. NO. 202023-20

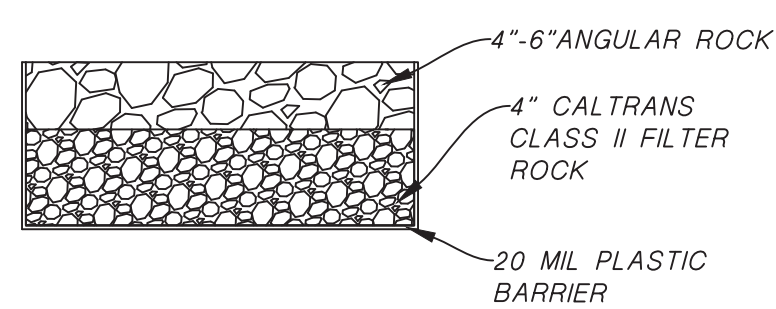
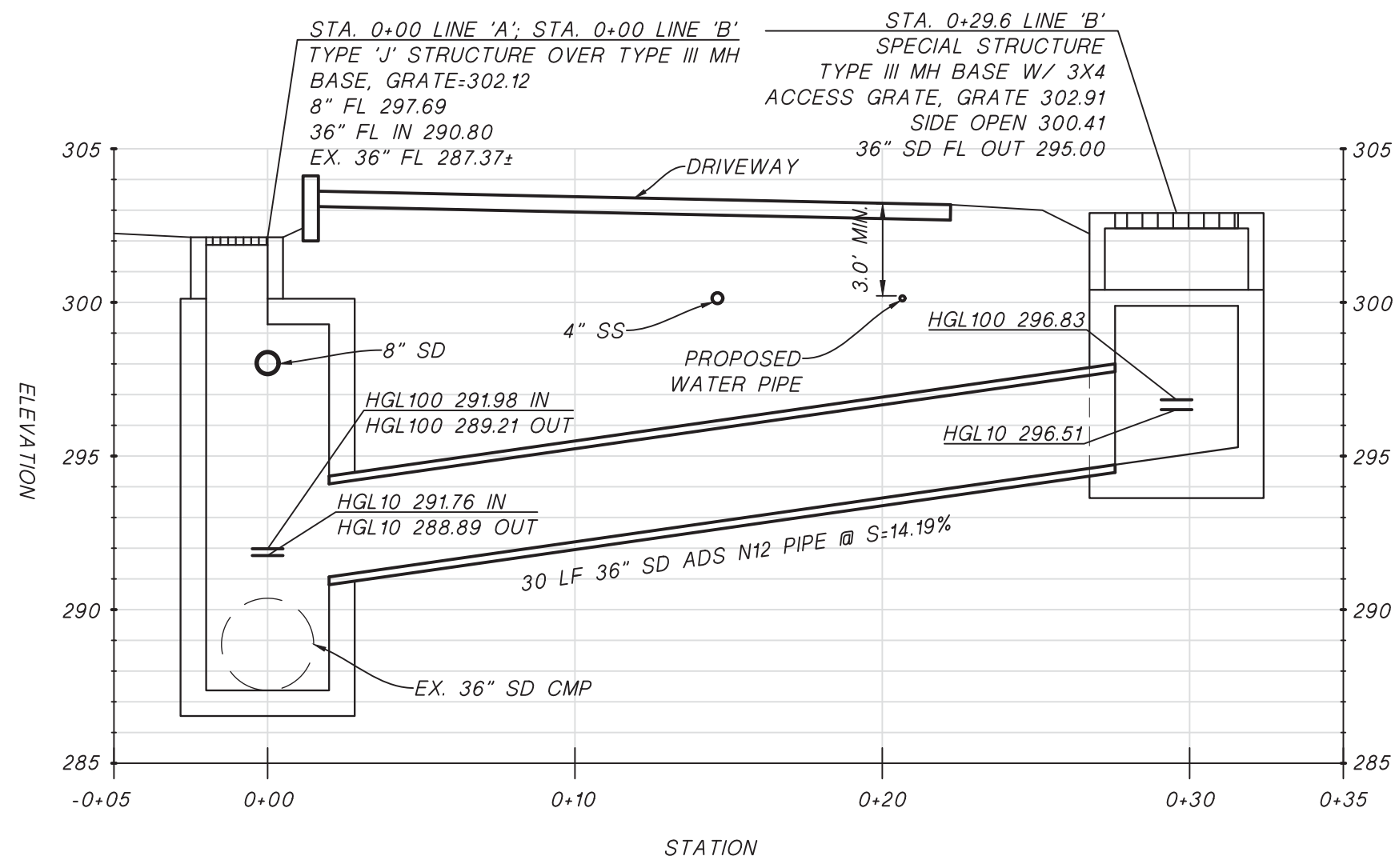
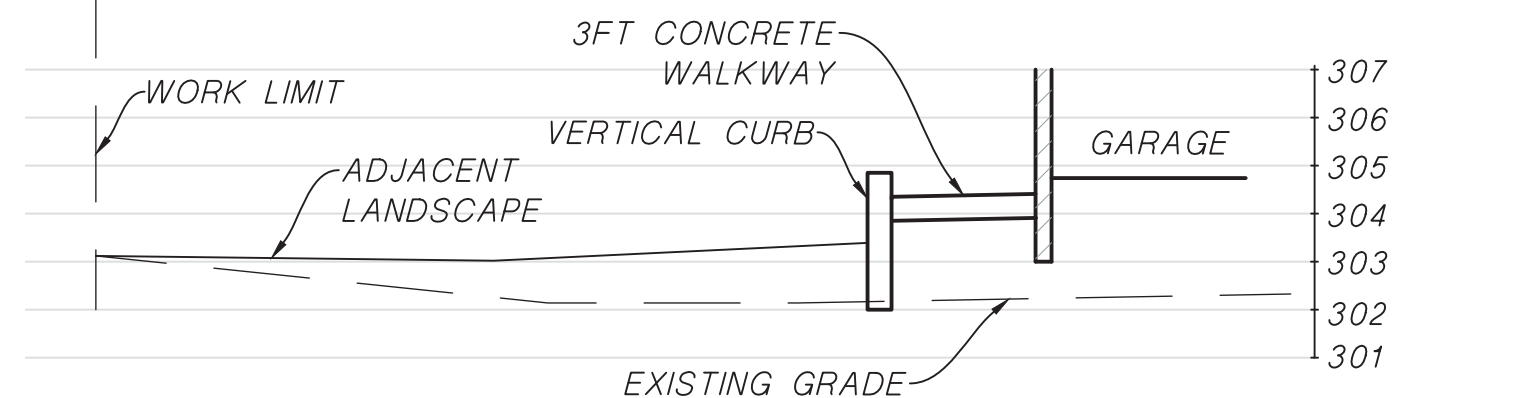
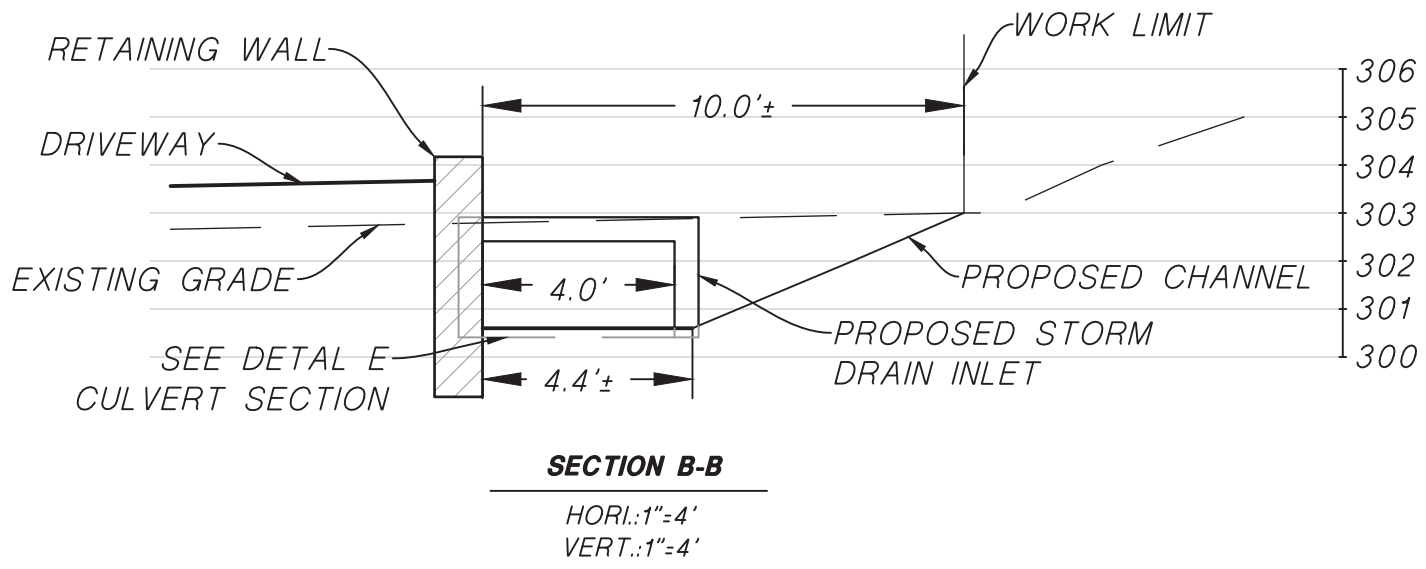
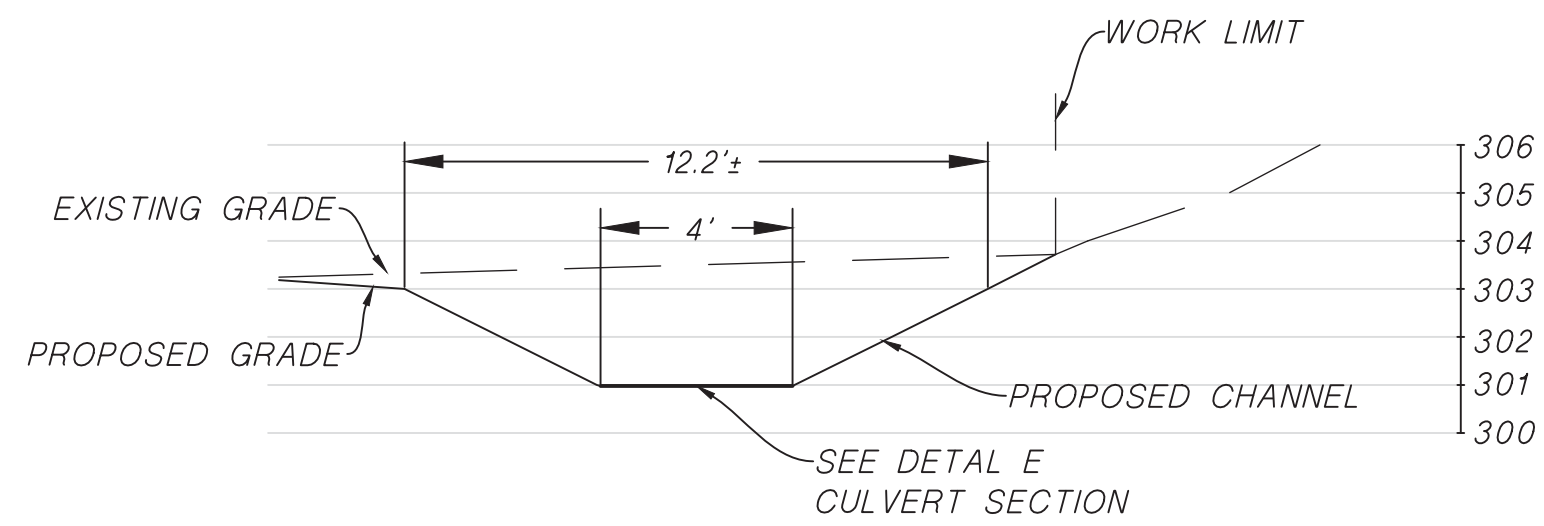

RAZMIK AVEDIAN
R.C.E. 53063 EXPIRES 6/30/21
P/A DESIGN RESOURCES, INC. DATE

LEGEND

- PROPERTY LINE
- LIMIT OF WORK
- GRADE BREAK
- SS --- SANITARY SEWER LINE
- SD --- STORM DRAIN LINE
- W --- WATER LINE
- RIP RAP
- CLEANOUT
- ▣ AREA DRAIN
- CHANNEL
- WALL RAILING TO BE INSTALLED AGAINST DROP OF 30" OR MORE FROM RETAINING WALL.

ABBREVIATIONS

- SS SANITARY SEWER
- SD STORM DRAIN
- MH MANHOLE
- SSCO SANITARY SEWER CLEANOUT
- AD AREA DRAIN
- STA. STATION
- FL FLOWLINE
- XING PIPE CROSSING
- B.O.P. BOTTOM OF PIPE
- T.O.P. TOP OF PIPE
- EX. EXISTING
- C CONCRETE
- TC TOP OF CURB
- G GROUND (LANDSCAPE)
- TW TOP OF WALL
- BW BOTTOM OF WALL
- FF FINISHED FLOOR

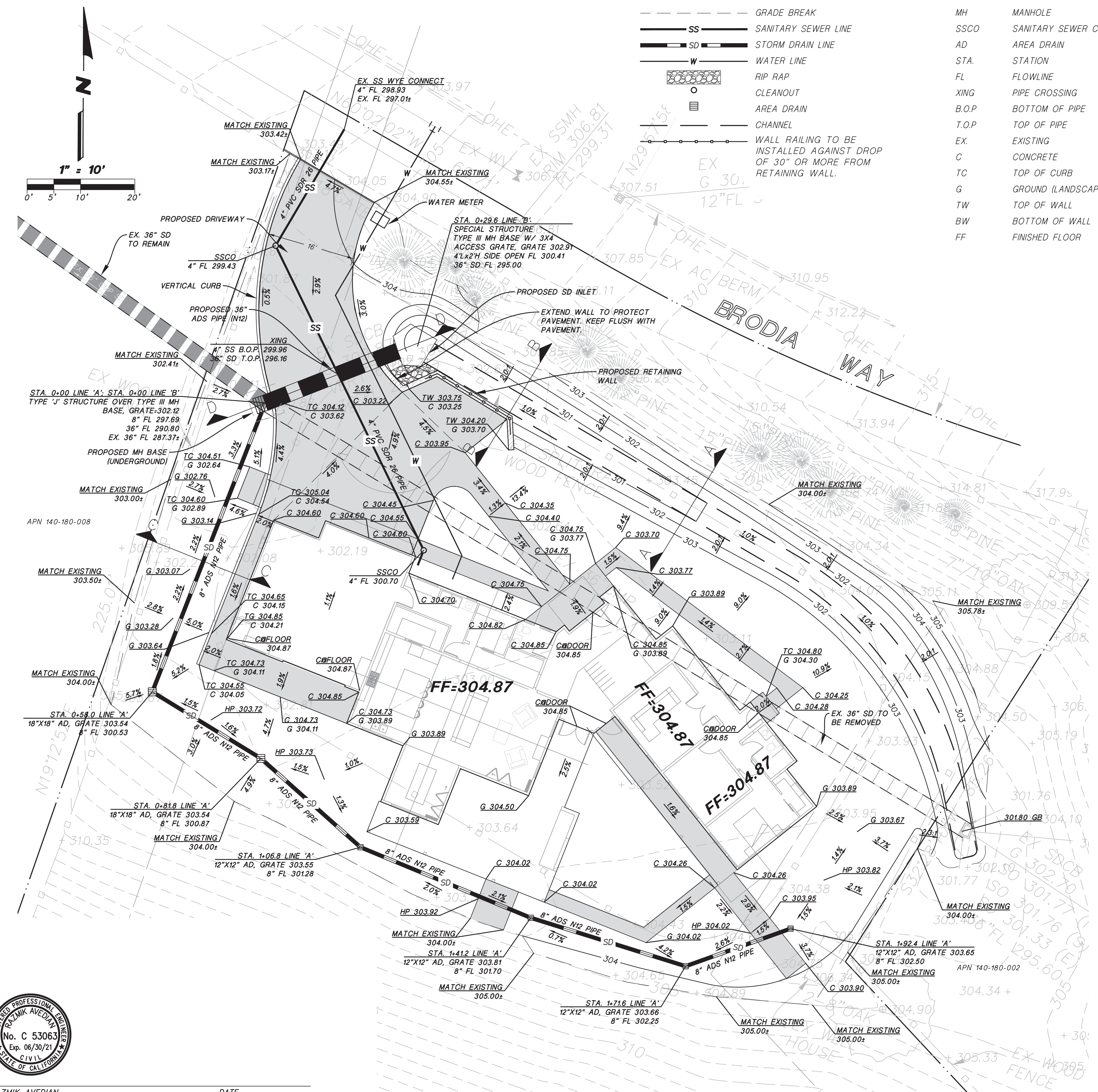

144 BRODIA WAY
APN 140-180-009
CONCEPTUAL GRADING PLAN

P/A Design Resources, Inc.
Planning ■ Engineering ■ Surveying

DATE: 07-15-2021
SCALE: HORIZ. 1"=10'
VERT.
DESIGN:
CHECKED:
SHEET 1
OF 2 SHEETS
PROJ. NO. 202023-20

REVISIONS
NO. BY DATE
CALIFORNIA
WALNUT CREEK
3021 Citrus Circle, Suite 150
Walnut Creek, California 94598-2635
TEL (925) 210-9300

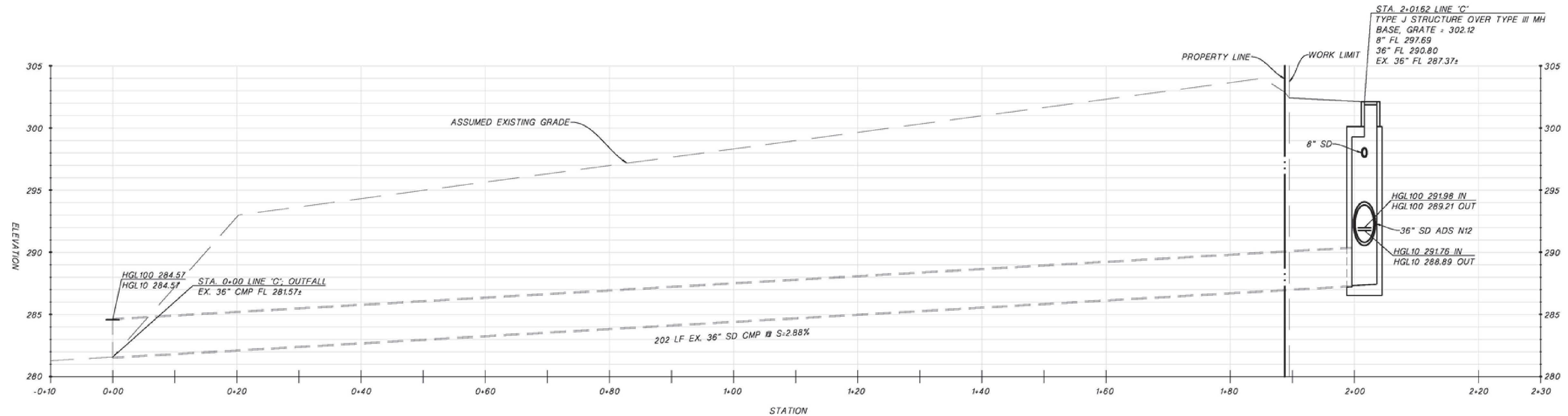
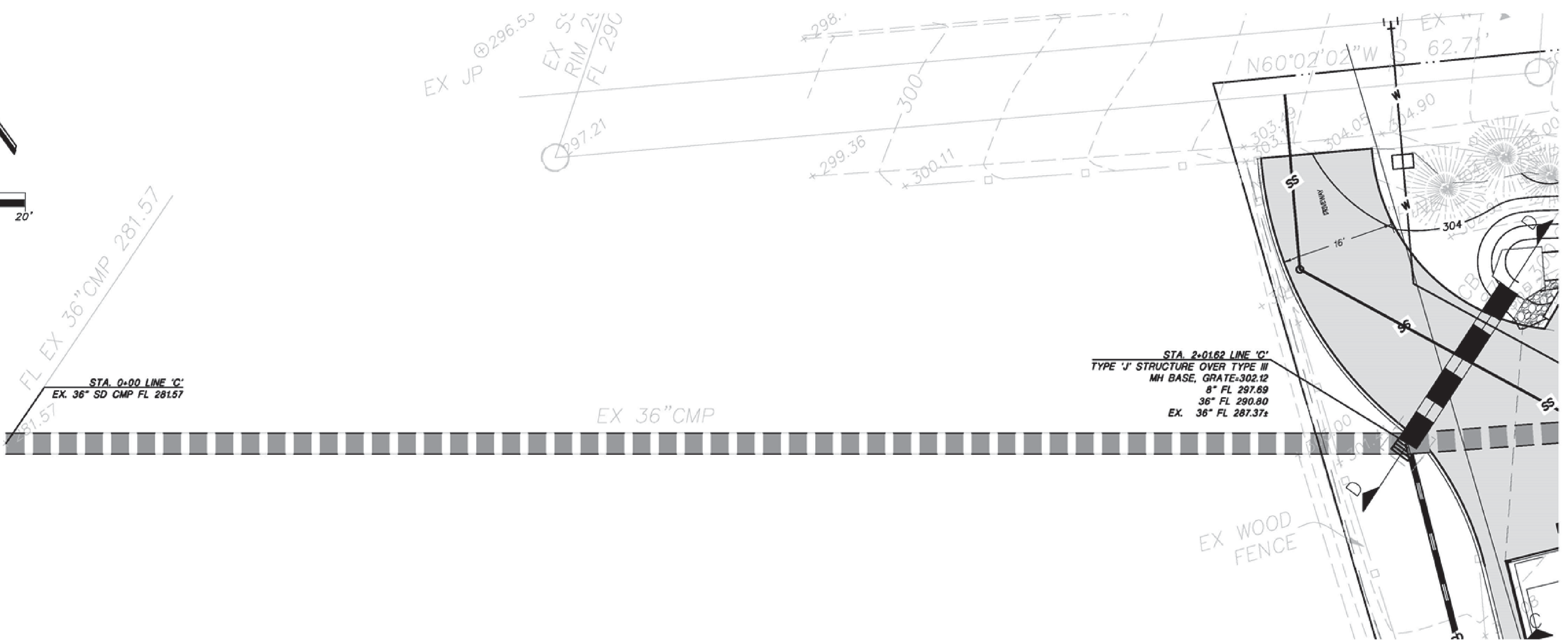
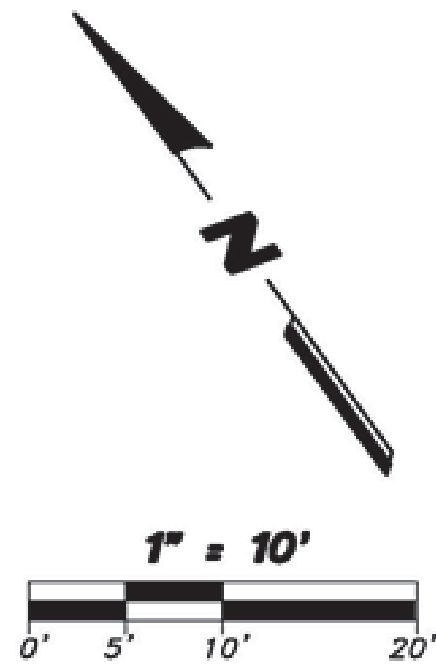

EXISTING 36" SD PROFILE

HORI.: 1"=10'
VERT.: 1"=5'

PRELIMINARY

NO.	BY	DATE	REVISIONS

144 BRODIA WAY
APN 140-180-009
**EXISTING STORM DRAIN
PLAN AND PROFILE**
WALNUT CREEK CALIFORNIA

PA Design Resources, Inc.
Planning ■ Engineering ■ Surveying
3021 Citrus Circle, Suite 150
Walnut Creek, California 94598-2635
TEL (925) 210-9300

DATE: 04-08-2021
SCALE: HORIZ. 1"=10'
VERT. 1"=5'
DESIGN:
CHECKED:
SHEET: 2
OF 2 SHEETS
PROJ. NO. 202023-20



CITE | DESIGNS
Patrick Vaucheret
214 Whitney Ct
Walnut Creek, CA 94598
1 415 637 6207

Owner:
Mangalpal Takhar and
Sonya Sachdeva

BRODIA WAY RESIDENCE

144 Brodia Way
WALNUT CREEK, CA

Contra Costa County
Dept. of Conservation
and Development
Community Development
Division

Planning Application
20 APRIL 2021

EXISTING
SITE PLAN

A1.1

EXISTING SITE PLAN NOTE

ALL EXISTING TREES WILL BE PRESERVED AND
UNDISTURBED BY PROPOSED SCOPE OF WORK..

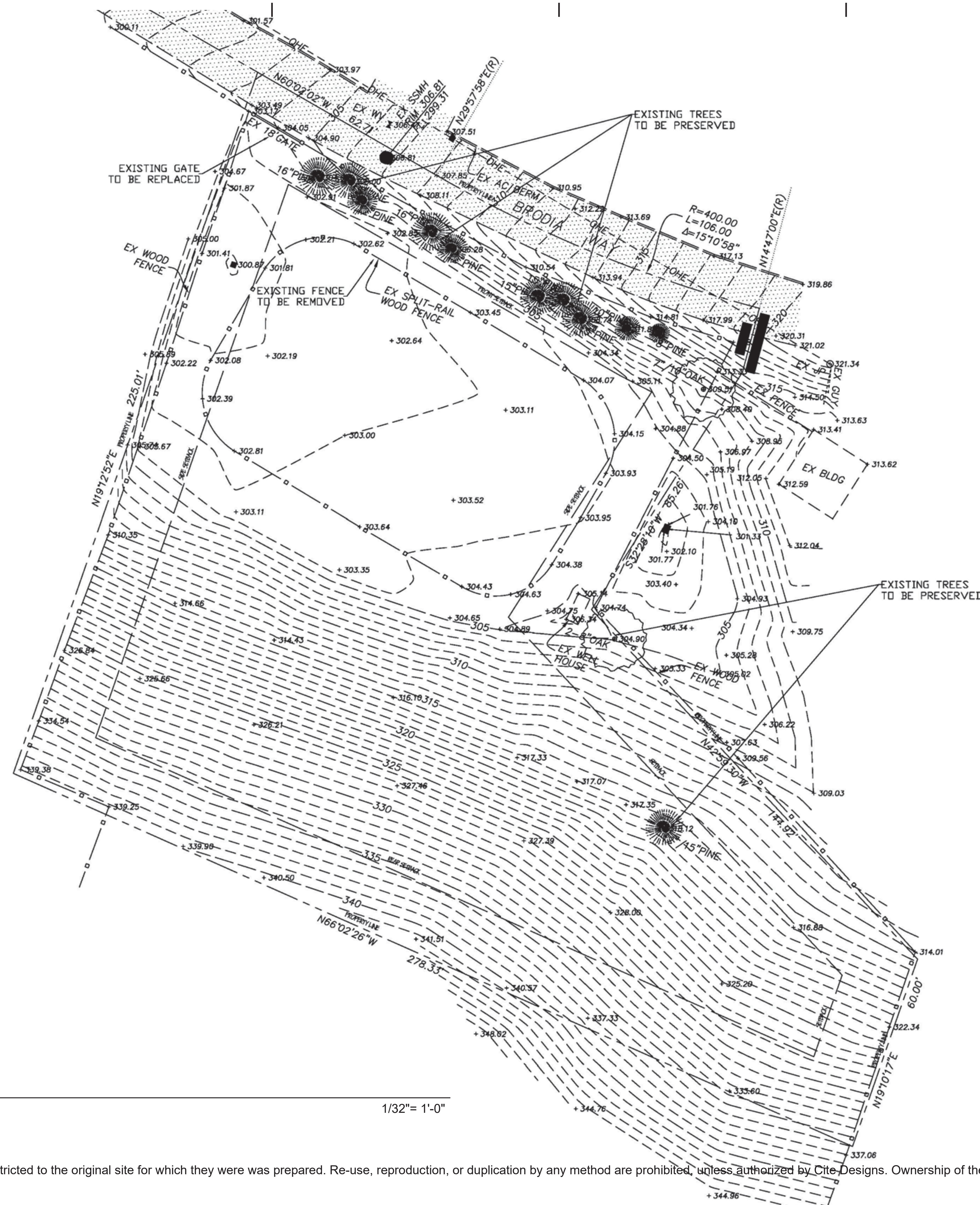

LEGEND

-  EXISTING PINE TREE PRESERVED
-  EXISTING OAK TREE PRESERVE

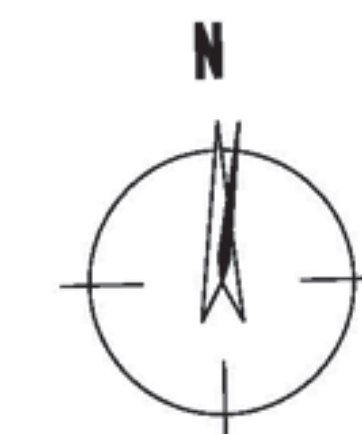

1 EXISTING SITE PLAN

1/32" = 1'-0"



CITE | DESIGNS
 Patrick Vaucheret
 214 Whitney Ct
 Walnut Creek, CA 94598
 1 415 637 6207

Owner:
 Mangalpal Takhar and
 Sonya Sachdeva

BRODIA WAY RESIDENCE

144 Brodia Way
 WALNUT CREEK, CA

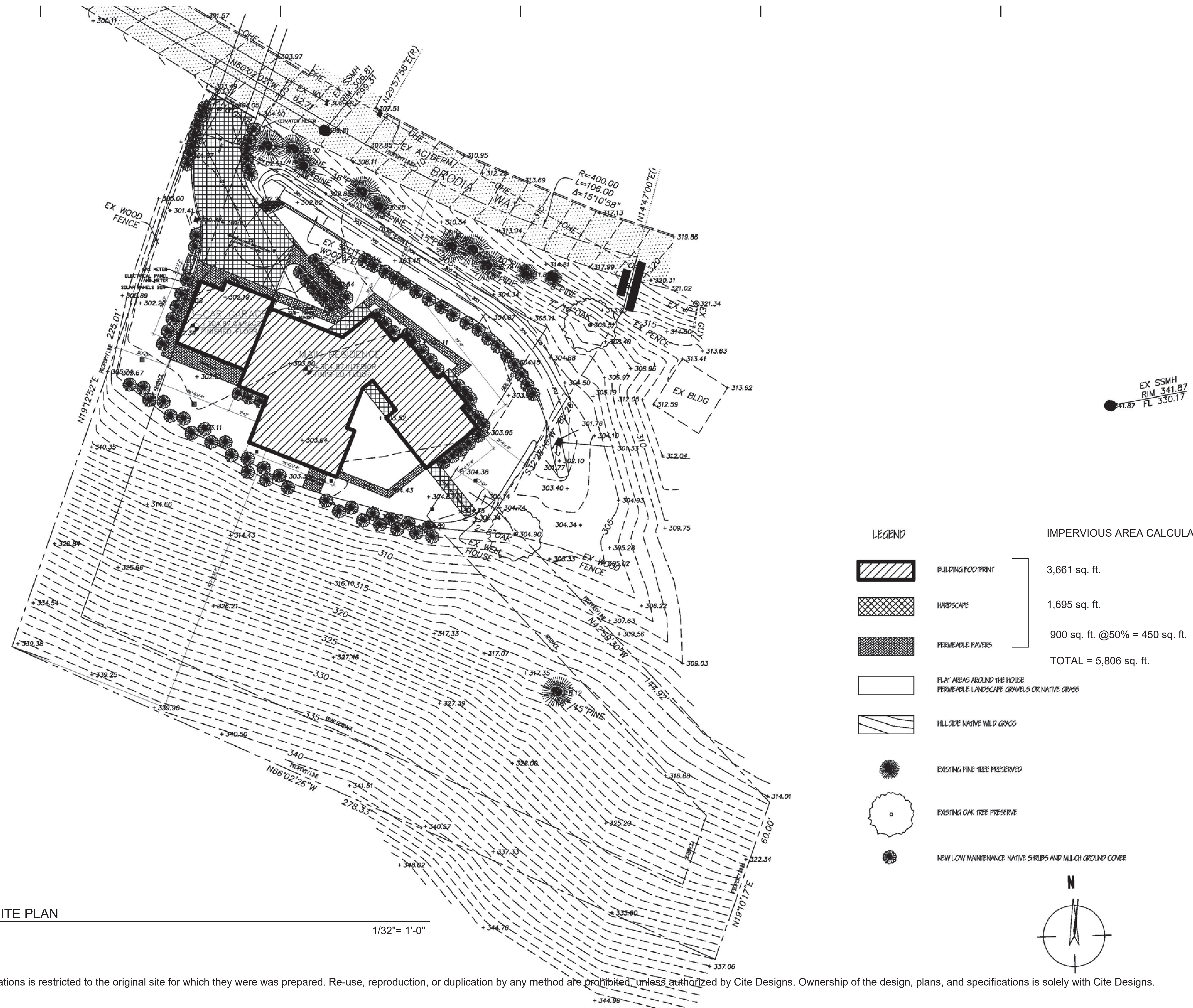

LEGEND		IMPERVIOUS AREA CALCULATIONS	
	BUILDING FOOTPRINT	}	3,661 sq. ft.
	HARDSCAPE		1,695 sq. ft.
	PERMEABLE PAVERS		900 sq. ft. @50% = 450 sq. ft.
			TOTAL = 5,806 sq. ft.
	FLAT AREAS AROUND THE HOUSE PERMEABLE LANDSCAPE GRAVELS OR NATIVE GRASS		
	HILLSIDE NATIVE WILD GRASS		
	EXISTING PINE TREE PRESERVED		
	EXISTING OAK TREE PRESERVE		
	NEW LOW MAINTENANCE NATIVE SHRUBS AND MULLCH GROUND COVER		

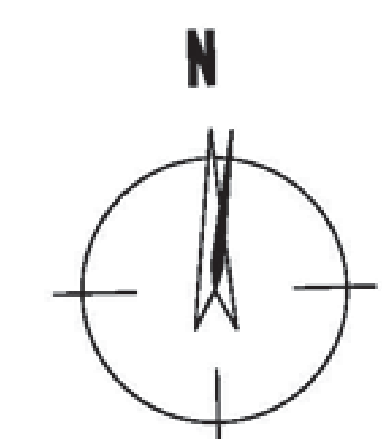

1 PROPOSED SITE PLAN

1/32" = 1'-0"

Contra Costa County
 Dept. of Conservation
 and Development
 Community Development
 Division

Planning Application
 20 APRIL 2021

**PROPOSED
 SITE PLAN**

A1.2



CITE I DESIGNS
Patrick Vaucheret
214 Whitney Ct
Walnut Creek, CA 94598
1 415 637 6207

Owner:
Mangalpal Takhar and
Sonya Sachdeva

BRODIA WAY RESIDENCE

144 Brodia Way
WALNUT CREEK, CA

Contra Costa County
Dept. of Conservation
and Development
Community Development
Division

Planning Application
20 APRIL 2021

ENLARGED
PROPOSED SITE
PLAN

A1.3

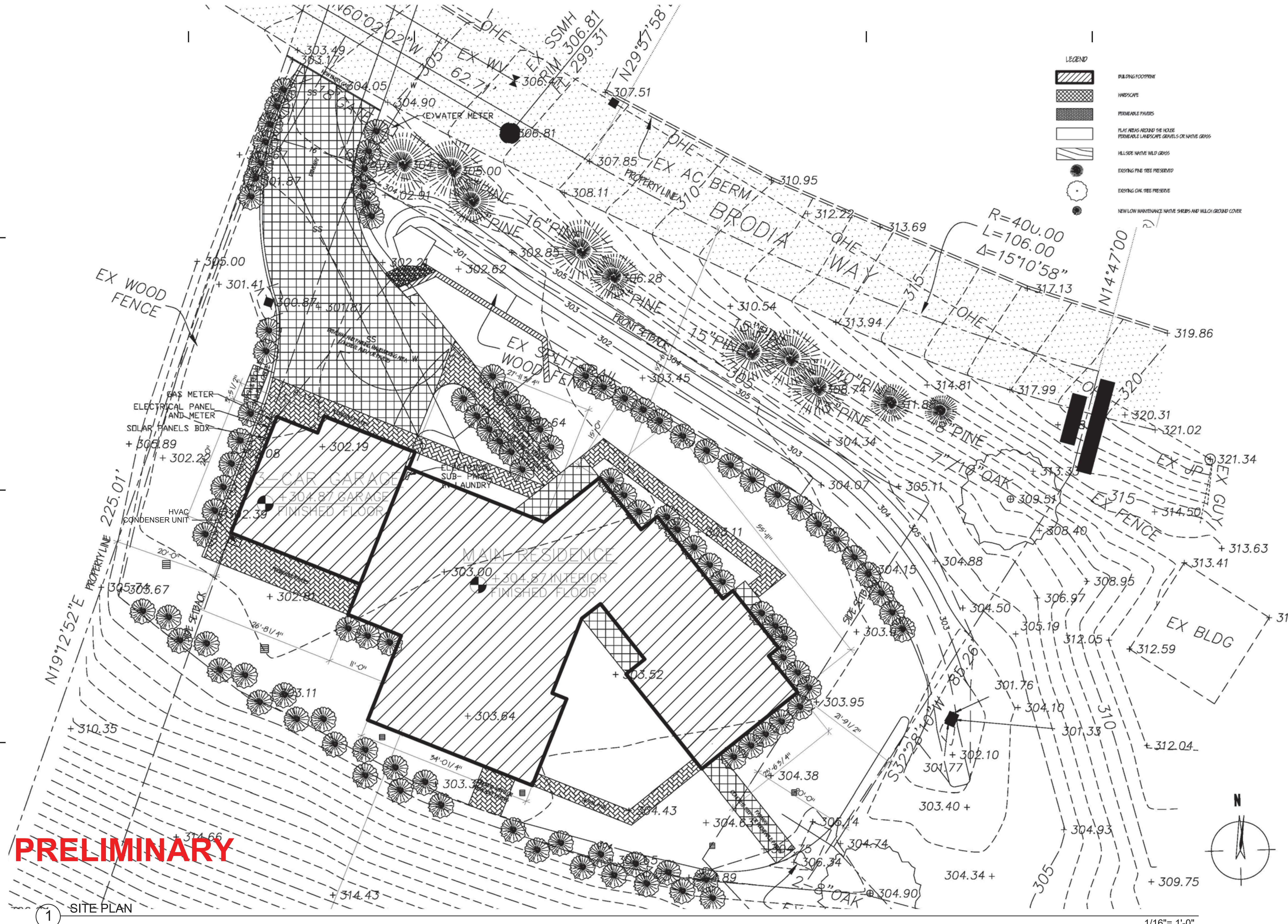

LEGEND

- BUILDING FOOTPRINT
- HARDSCAPE
- PERMEABLE PAVERS
- PLANT AREAS AROUND THE HOUSE PERMEABLE LANDSCAPE GRAVELS OR NATIVE GRASS
- HILLSIDE NATIVE WILD GRASS
- EXISTING PINE TREE PRESERVE
- EXISTING OAK TREE PRESERVE
- NEW LOW MAINTENANCE NATIVE SHRUBS AND MILCH GROUND COVER

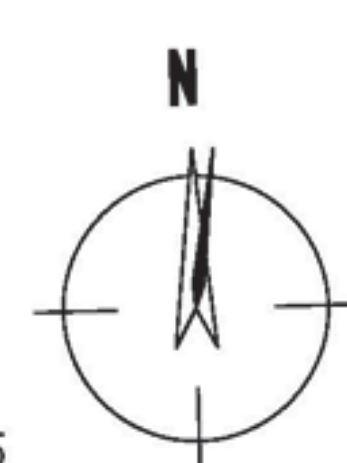

1/16" = 1'-0"

PRELIMINARY

1 SITE PLAN

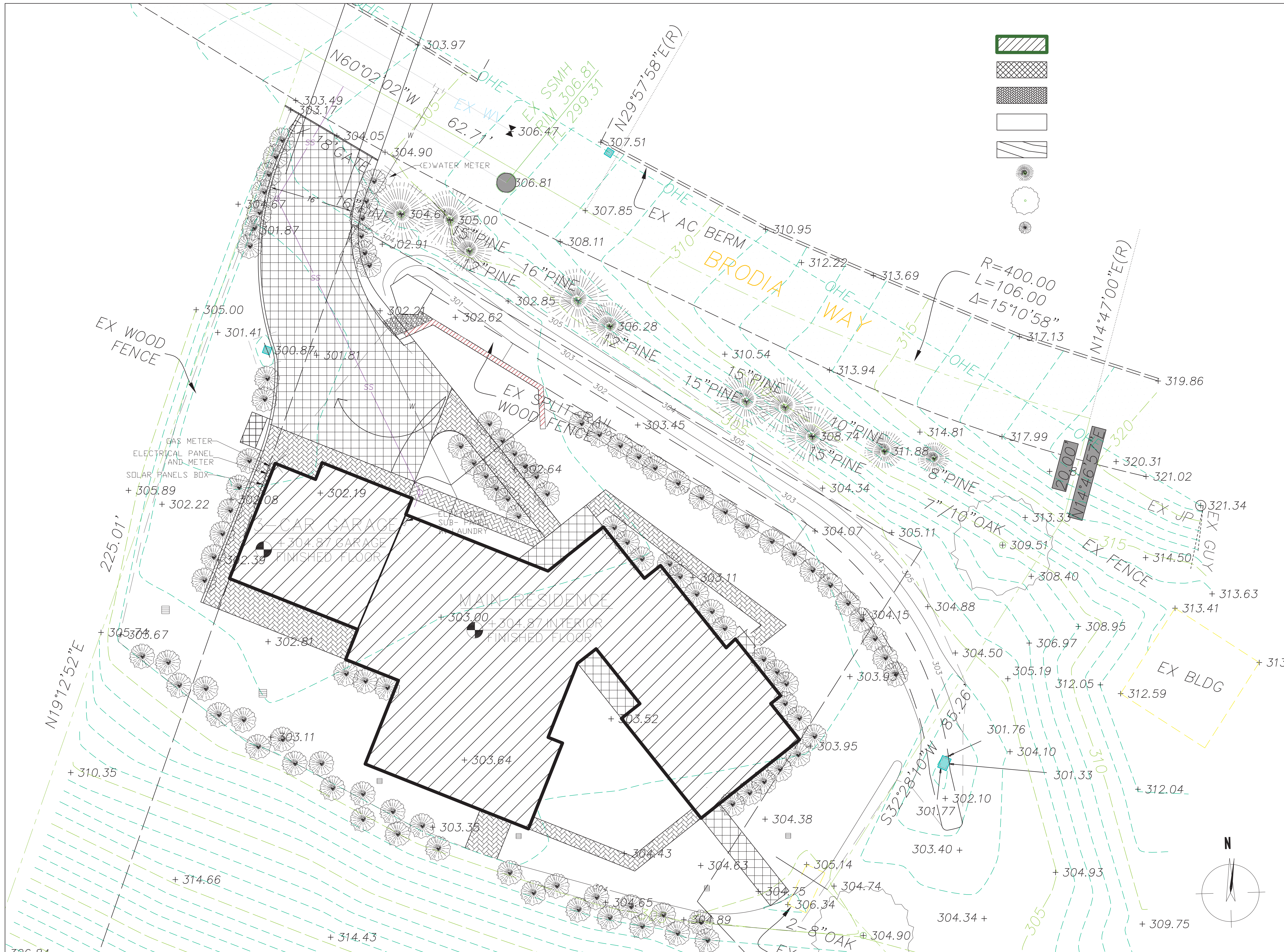

Designer
 CITE I DESIGNS
 214 Whitney Ct
 Walnut Creek, CA 94598
 415-637-6207
 patrick.vaucheret@citedesigns.com

Patrick Vaucheret, Designer
 CITE I DESIGNS

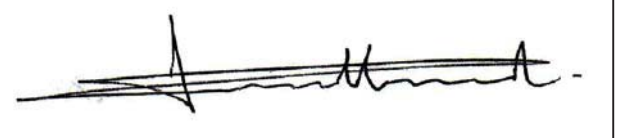

Structural Engineer
 TBD

Owner
 Manasipal Fakler and Sonja Sachdeva
 144 Brodia Way
 Walnut Creek, Ca 94598

Schematic Designer
 Contra Costa County

REVISIONS	DATE

BRODIA WAY RESIDENCE
 144 BRODIA WAY
 WALNUT CREEK, CA 94598

DATE:	06/21/2021
SCALE:	AS NOTED
DRAWN:	CITE I DESIGNS
CHECKED:	
JOB NO.:	
SHEET	SITE PLAN



CITE I DESIGNS
Patrick Vaucheret
214 Whitney Ct
Walnut Creek, CA 94598
1 415 637 6207

Owner:
Mangalpal Takhar and
Sonya Sachdeva

BRODIA WAY RESIDENCE

144 Brodia Way
WALNUT CREEK, CA

Contra Costa County
Dept. of Conservation
and Development
Community Development
Division

Planning Application
20 APRIL 2021

FIRST FLOOR PLAN

A2.1

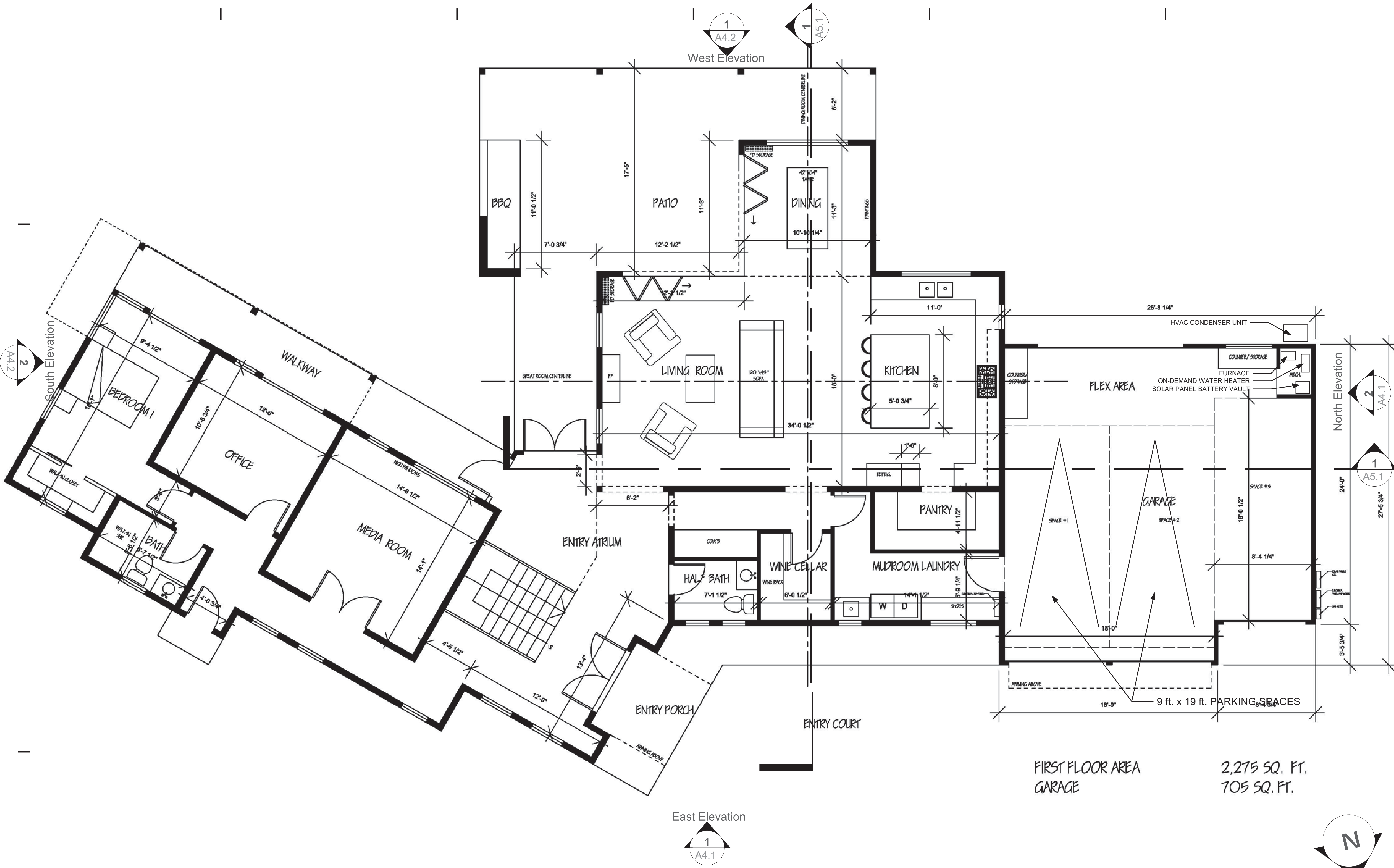

FIRST FLOOR AREA
GARAGE
2,275 SQ. FT.
705 SQ. FT.

1 FIRST FLOOR

1/8" = 1'-0"



CITE I DESIGNS
Patrick Vaucheret
214 Whitney Ct
Walnut Creek, CA 94598
1 415 637 6207

Owner:
Mangalpal Takhar and
Sonya Sachdeva

BRODIA WAY RESIDENCE

144 Brodia Way
WALNUT CREEK, CA

Contra Costa County
Dept. of Conservation
and Development
Community Development
Division

Planning Application
20 APRIL 2021

**UPPER FLOOR
PLAN**

A2.2

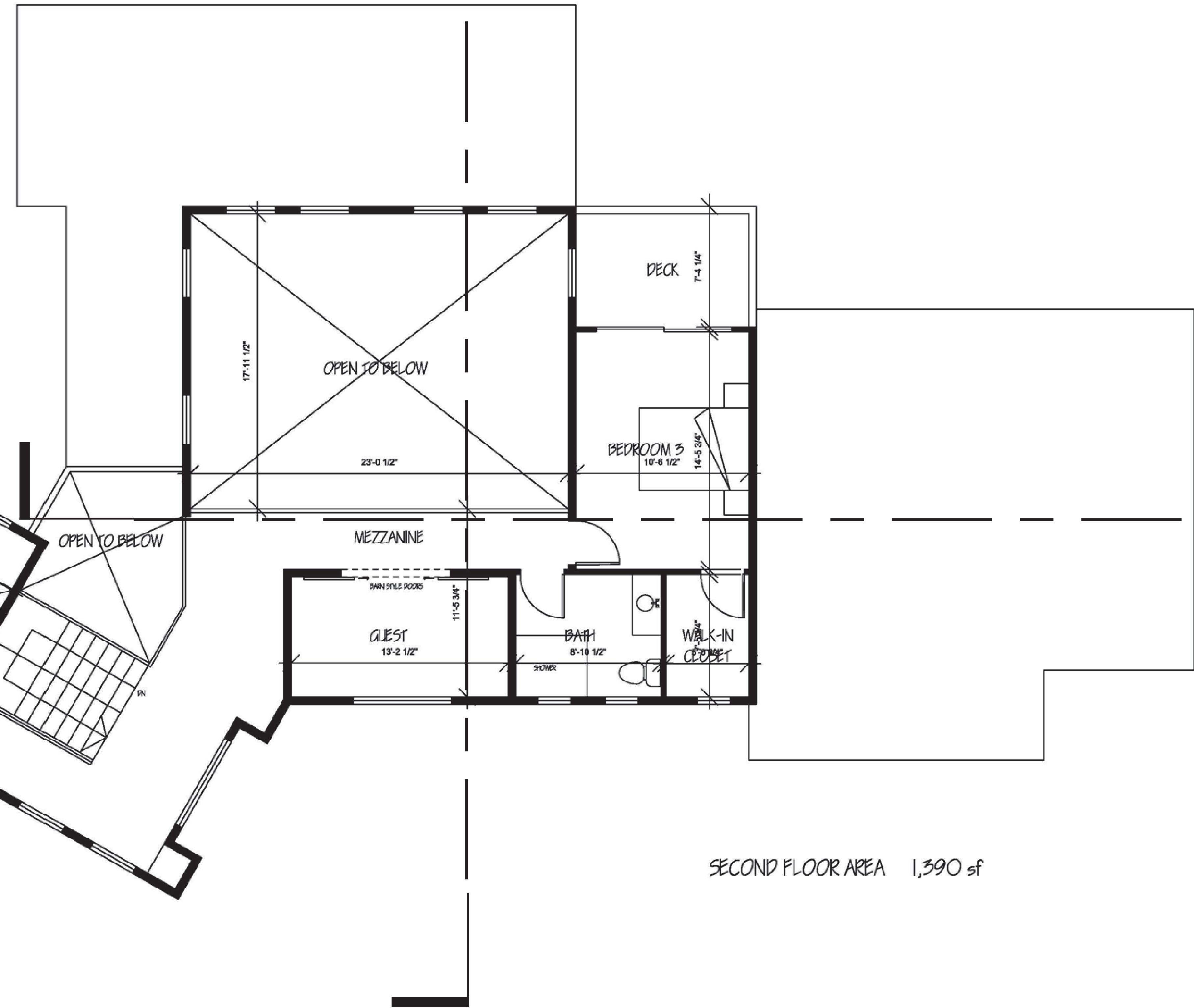
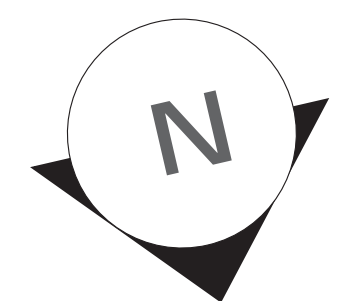
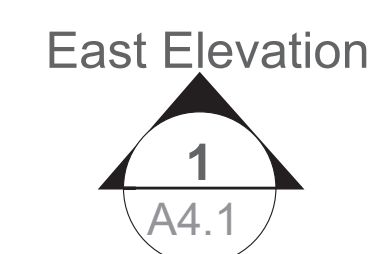
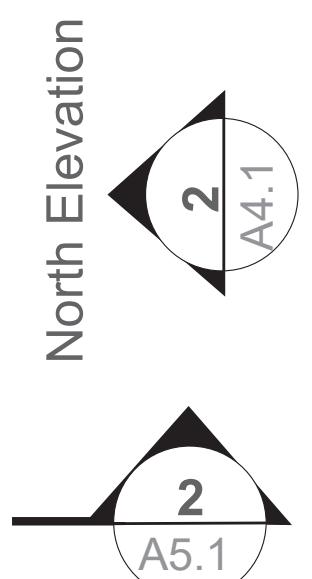

SECOND FLOOR AREA 1,390 sf

1 FIRST FLOOR

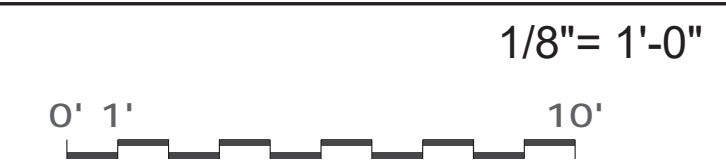



CITE I DESIGNS
Patrick Vaucheret
214 Whitney Ct
Walnut Creek, CA 94598
1 415 637 6207

Owner:
Mangalpal Takhar and
Sonya Sachdeva

BRODIA WAY RESIDENCE

144 Brodia Way
WALNUT CREEK, CA

Contra Costa County
Dept. of Conservation
and Development
Community Development
Division

Planning Application
20 APRIL 2021

ROOF PLAN

A2.3

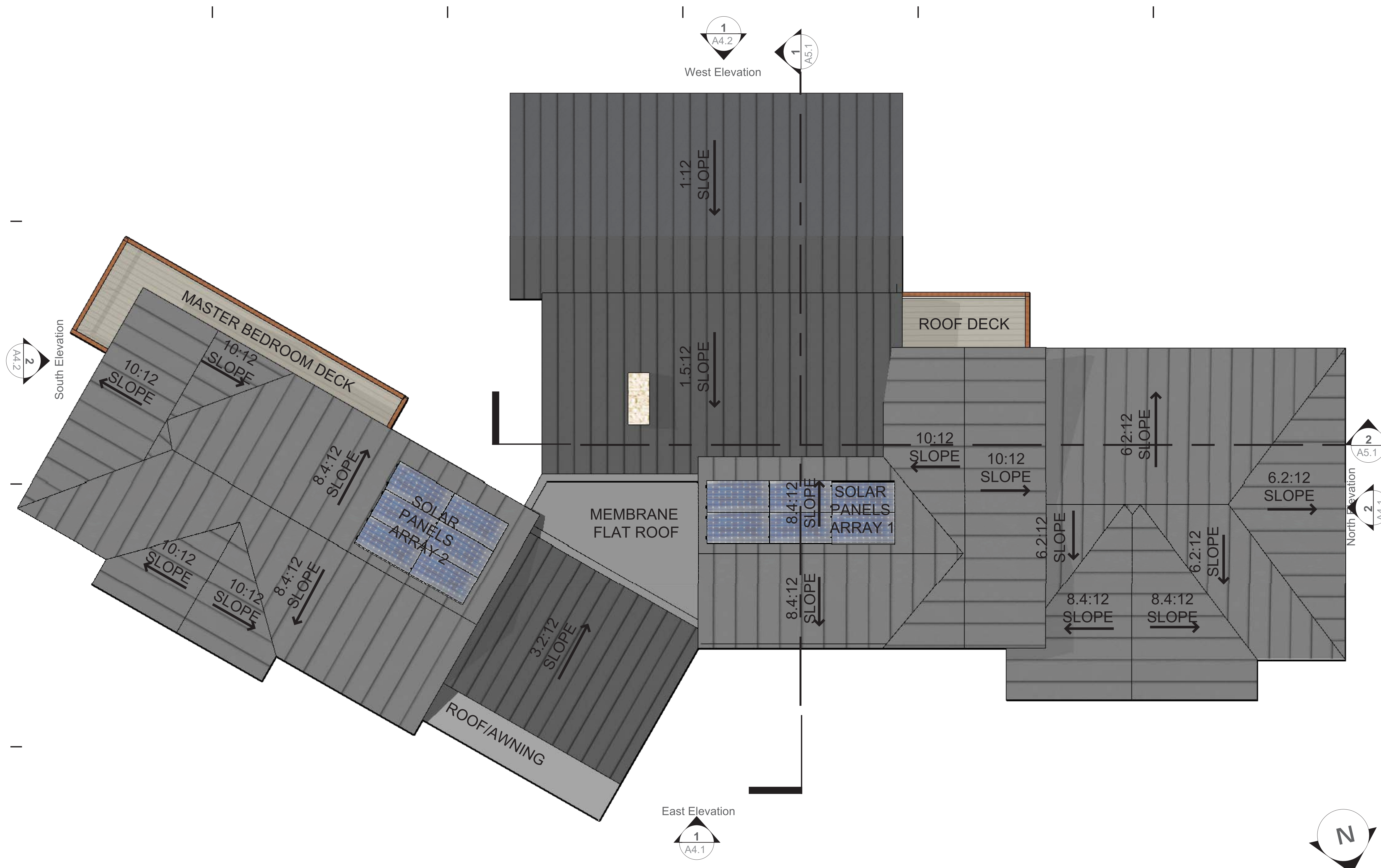

1 ROOF PLAN

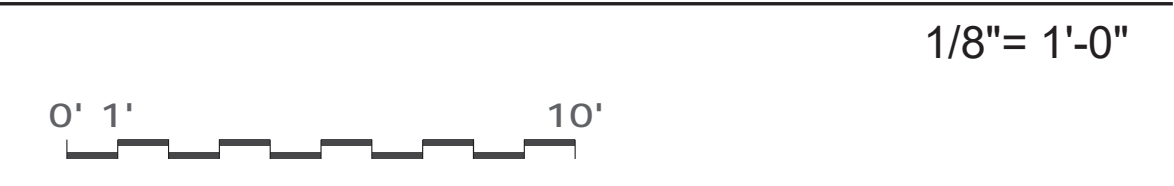
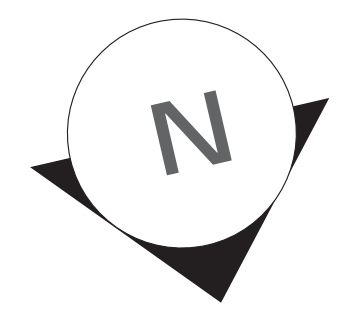



CITE I DESIGNS
 Patrick Vaucheret
 214 Whitney Ct
 Walnut Creek, CA 94598
 1 415 637 6207
 Owner:
 Mangalpal Takhar and
 Sonya Sachdeva

BRODIA WAY RESIDENCE

144 Brodia Way
 WALNUT CREEK, CA

Contra Costa County
 Dept. of Conservation
 and Development
 Community Development
 Division

Planning Application
 20 APRIL 2021

**ELEVATIONS AND
 MATERIALS**

A4.1



- GREY STANDING SEAM METAL ROOF TYP.
- DARK FRAME / CLEAR GLASS WINDOW TYP.
- DARK GREY VERTICAL METAL SIDING TYP.
- ENTRY SUSPENDED METAL CANOPY - GREY
- HORIZONTAL COMPOSITE BOARDS WOODTONE OR SIMILAR SIDING ACCENTS TYP.
- WHITE OR CREAM BOARD AND BATTEN SIDING TYP.
- LIMESTONE TONE STONE VENEER TYP.
- SUSPENDED METAL CANOPY - GREY
- HERINGBONE SPANISH STYLE WOOD GARAGE DOORS

1 EAST ELEVATION (ALONG BRODIA WAY) - SEE SHEET A6.1 FOR MATERIALS SAMPLES

1/8" = 1'-0"

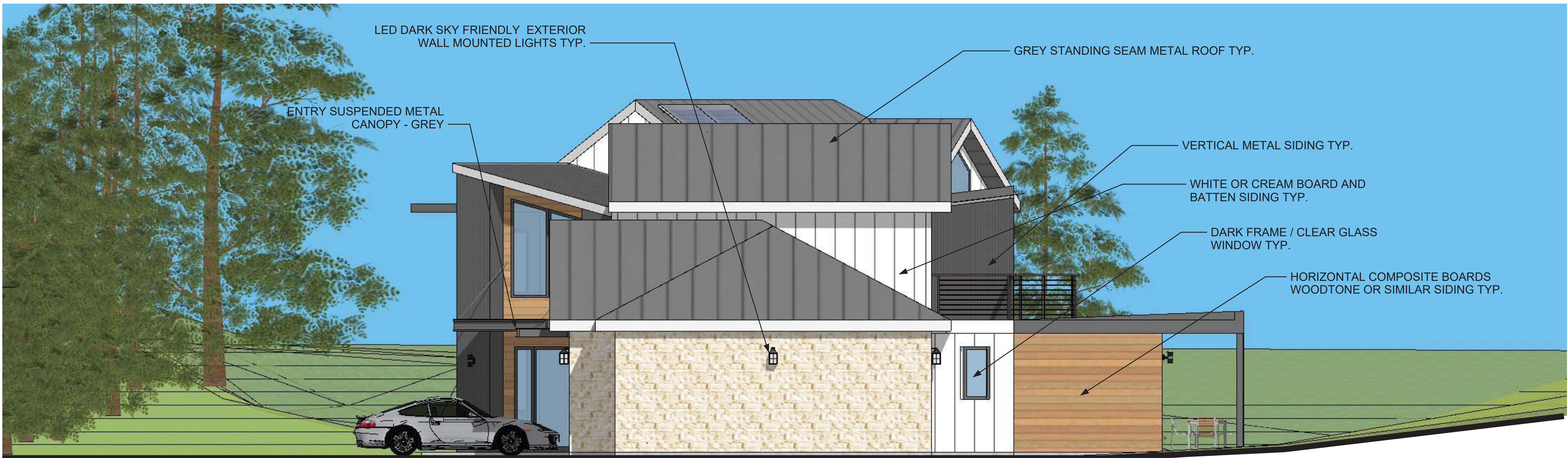

- LED DARK SKY FRIENDLY EXTERIOR WALL MOUNTED LIGHTS TYP.
- ENTRY SUSPENDED METAL CANOPY - GREY
- GREY STANDING SEAM METAL ROOF TYP.
- VERTICAL METAL SIDING TYP.
- WHITE OR CREAM BOARD AND BATTEN SIDING TYP.
- DARK FRAME / CLEAR GLASS WINDOW TYP.
- HORIZONTAL COMPOSITE BOARDS WOODTONE OR SIMILAR SIDING TYP.

2 NORTH ELEVATION - SEE SHEET A6.1 FOR MATERIALS SAMPLES

1/8" = 1'-0"



CITE I DESIGNS
Patrick Vaucheret
214 Whitney Ct
Walnut Creek, CA 94598
1 415 637 6207

Owner:
Mangalpal Takhar and
Sonya Sachdeva

BRODIA WAY RESIDENCE

144 Brodia Way
WALNUT CREEK, CA

Contra Costa County
Dept. of Conservation
and Development
Community Development
Division

Planning Application
20 APRIL 2021

ELEVATIONS AND
MATERIALS

A4.2

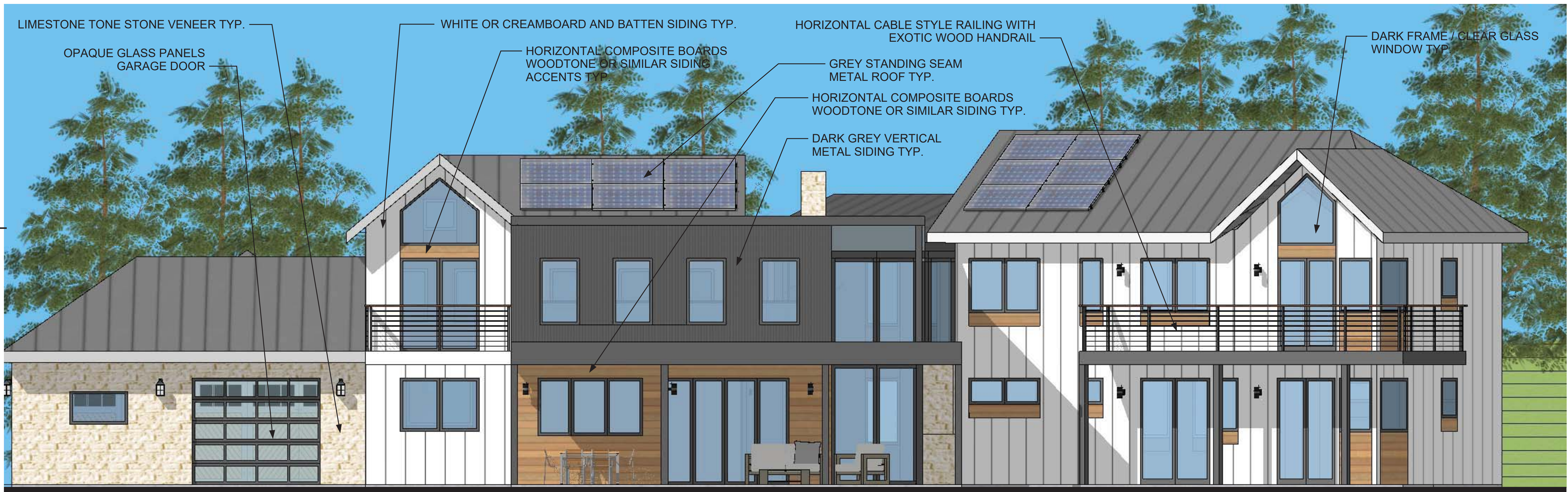

1 WEST ELEVATION - SEE SHEET A6.1 FOR MATERIALS SAMPLES

1/8" = 1'-0"

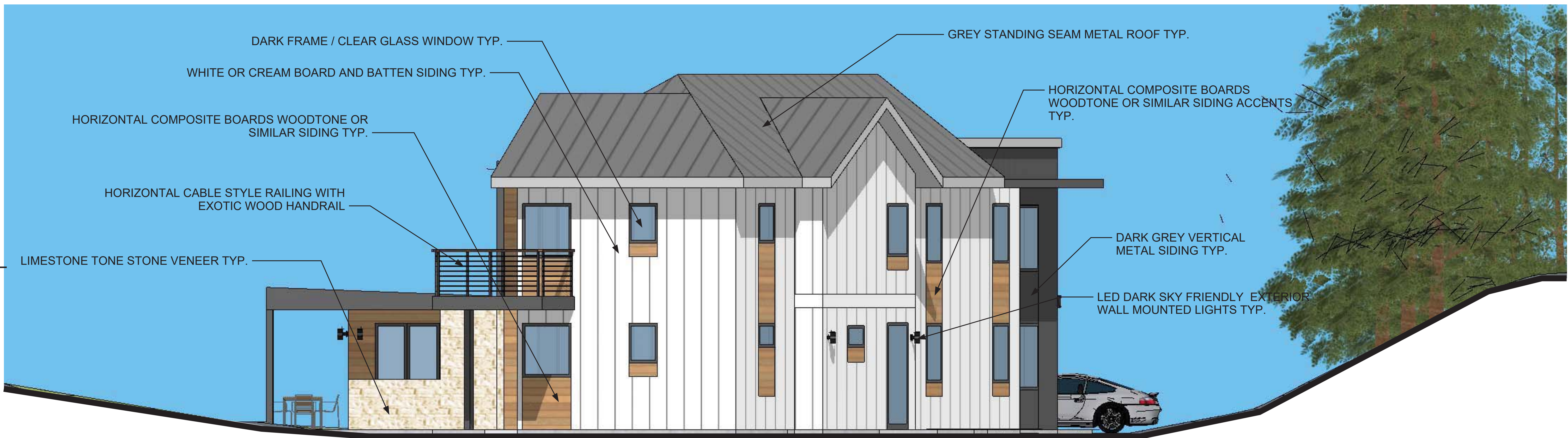

2 SOUTH ELEVATION ELEVATION - SEE SHEET A6.1 FOR MATERIALS SAMPLES

1/8" = 1'-0"



CITE I DESIGNS
Patrick Vaucheret
214 Whitney Ct
Walnut Creek, CA 94598
1 415 637 6207

Owner:
Mangalpal Takhar and
Sonya Sachdeva

BRODIA WAY RESIDENCE

144 Brodia Way
WALNUT CREEK, CA



1 EAST-WEST SECTION

1/8"= 1'-0"



2 NORTH-SOUTH SECTION

1/8"= 1'-0"

Contra Costa County
Dept. of Conservation
and Development
Community Development
Division

Planning Application
20 APRIL 2021

SECTIONS

A5.1



CITE | DESIGNS
Patrick Vaucheret
214 Whitney Ct
Walnut Creek, CA 94598
1 415 637 6207

Owner:
Mangalpal Takhar and
Sonya Sachdeva

BRODIA WAY RESIDENCE

144 Brodia Way
WALNUT CREEK, CA

Contra Costa County
Dept. of Conservation
and Development
Community Development
Division

Planning Application
20 APRIL 2021

ARCHITECTURAL
REFERENCES AND
MATERIALS

A6.1



VERTICAL METAL SIDING

METAL AWNING

STONE VENEER (GARAGE AND ACCENTS)

BOARD AND BATTEN SIDING

PATIO AS OUTDOOR ROOM AND
EXTENSION OF THE LIVING ROOM

STONE VENEER
(GARAGE AND ACCENTS)

ARCHITECTURAL MODULATION

PERMEABLE PAVEMENT AND NATIVE SHRUBS

STANDING SEAM METAL ROOF

TWO STORY VERTICAL
OPENING EXPRESSION

ARCHITECTURAL MODULATION

USE ENTRY TO CREATE A FOCAL POINT

BOARD AND BATTEN SIDING

STANDING SEAM METAL ROOF
AND SIDING PATTERN HARMONY



ENTRY AWNING

BOARD AND BATTEN SIDING

STAIRS AS A CENTRAL KEY FEATURE

USE ENTRY TO CREATE A FOCAL POINT



STEPPING STONES TO ENTRY

ENTRY AWNING



1 EAST SIDE*

2 WEST SIDE*

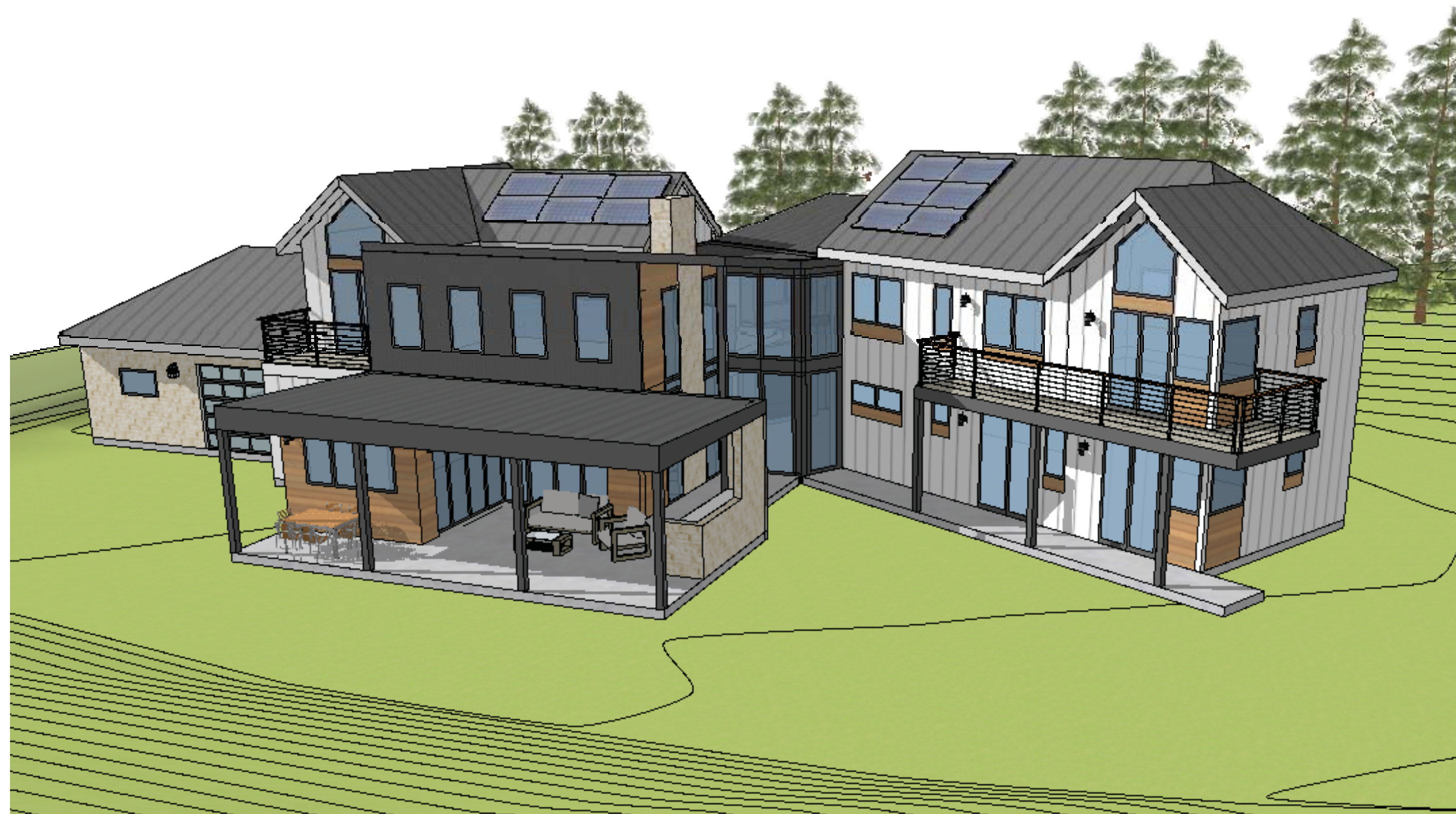

3 SOUTH SIDE*



4 ENTRY COURT FROM BRODIA WAY*

*VIEWS OF HOUSE AND TERRAIN CONCEPTUAL MODEL FOR ILLUSTRATION PURPOSES



CITE I DESIGNS
Patrick Vaucheret
214 Whitney Ct
Walnut Creek, CA 94598
1 415 637 6207

Owner:
Mangalpal Takhar and
Sonya Sachdeva

BRODIA WAY RESIDENCE

144 Brodia Way
WALNUT CREEK, CA

Contra Costa County
Dept. of Conservation
and Development
Community Development
Division

Planning Application
20 APRIL 2021

ILLUSTRATIVE
PERSPECTIVES

A7.1



144 Brodia Way, Walnut Creek

Appeal of Tree Permit

County File #CDTP21-00031

Tree Permit for the construction of a new house on a vacant lot





Project Description

This is a hearing on an appeal of the County Planning Commission's decision to approve a tree permit to allow work within the dripline of eleven code protected trees on a vacant lot for the construction of a new 3,665-square-foot single-family residence.

The construction includes grading of 190 cubic yards of cut, and 270 cubic yards of fill.

-
-
-

The project had originally received approval under the Zoning Administrator but received an appeal to the decision.

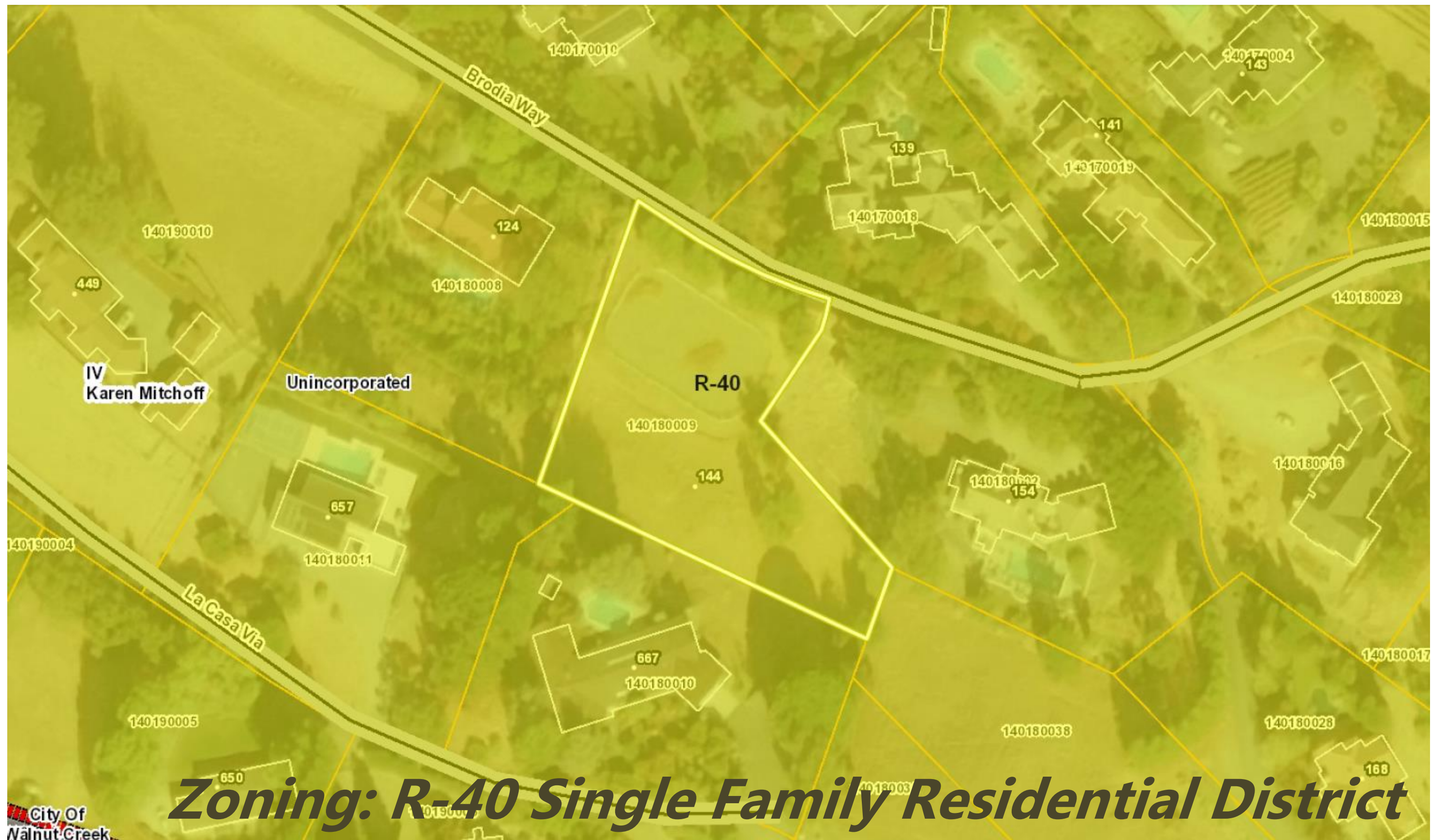



City of Walnut Creek

General Plan: Single Family Residential Very -Low Density







Current Site





Current Site



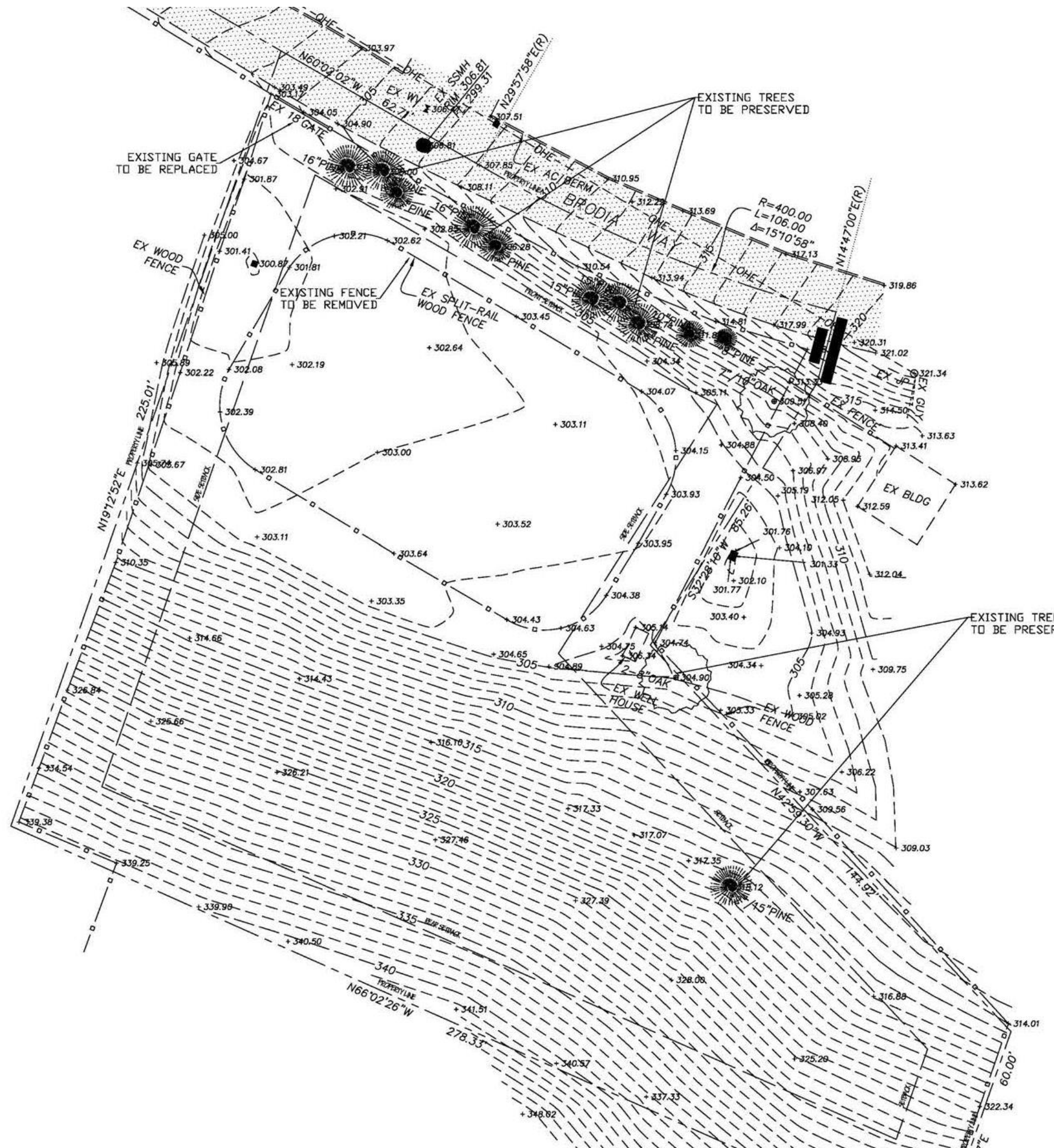



EXISTING SITE PLAN NOTE

ALL EXISTING TREES WILL BE PRESERVED AND UNDISTURBED BY PROPOSED SCOPE OF WORK.

LEGEND

-  EXISTING PINE TREE PRESERVED
-  EXISTING OAK TREE PRESERVE

Existing Site Plan

N







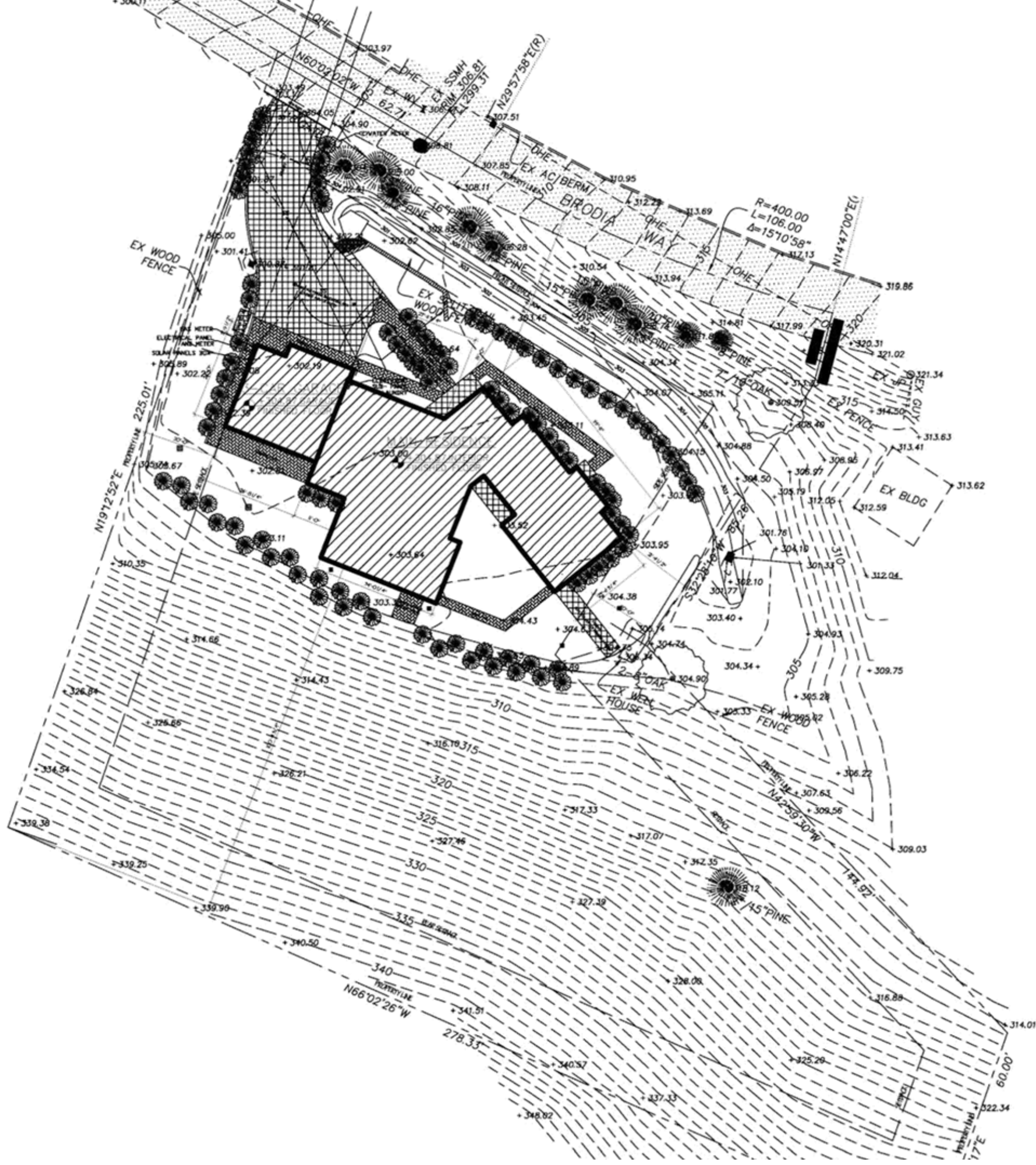





Proposed Site Plan



EX SSMH
RIM 341.87
FL 330.17

LEGEND

-  BUILDING FOOTPRINT
-  HARDSCAPE
-  PERMEABLE PAVERS
-  FLAT AREAS AROUND THE HOUSE
PERMEABLE LANDSCAPE GRAVELS OR NATIVE GRASS
-  HILLSIDE NATIVE WILD GRASS
-  EXISTING PINE TREE PRESERVED
-  EXISTING OAK TREE PRESERVE
-  NEW LOW MAINTENANCE NATIVE SHRUBS AND MILCH GROUND COVER

IMPERVIOUS AREA CALCULATIONS

3,661 sq. ft.
1,695 sq. ft.
900 sq. ft. @50% = 450 sq. ft.
TOTAL = 5,806 sq. ft.



N

Proposed Site Plan

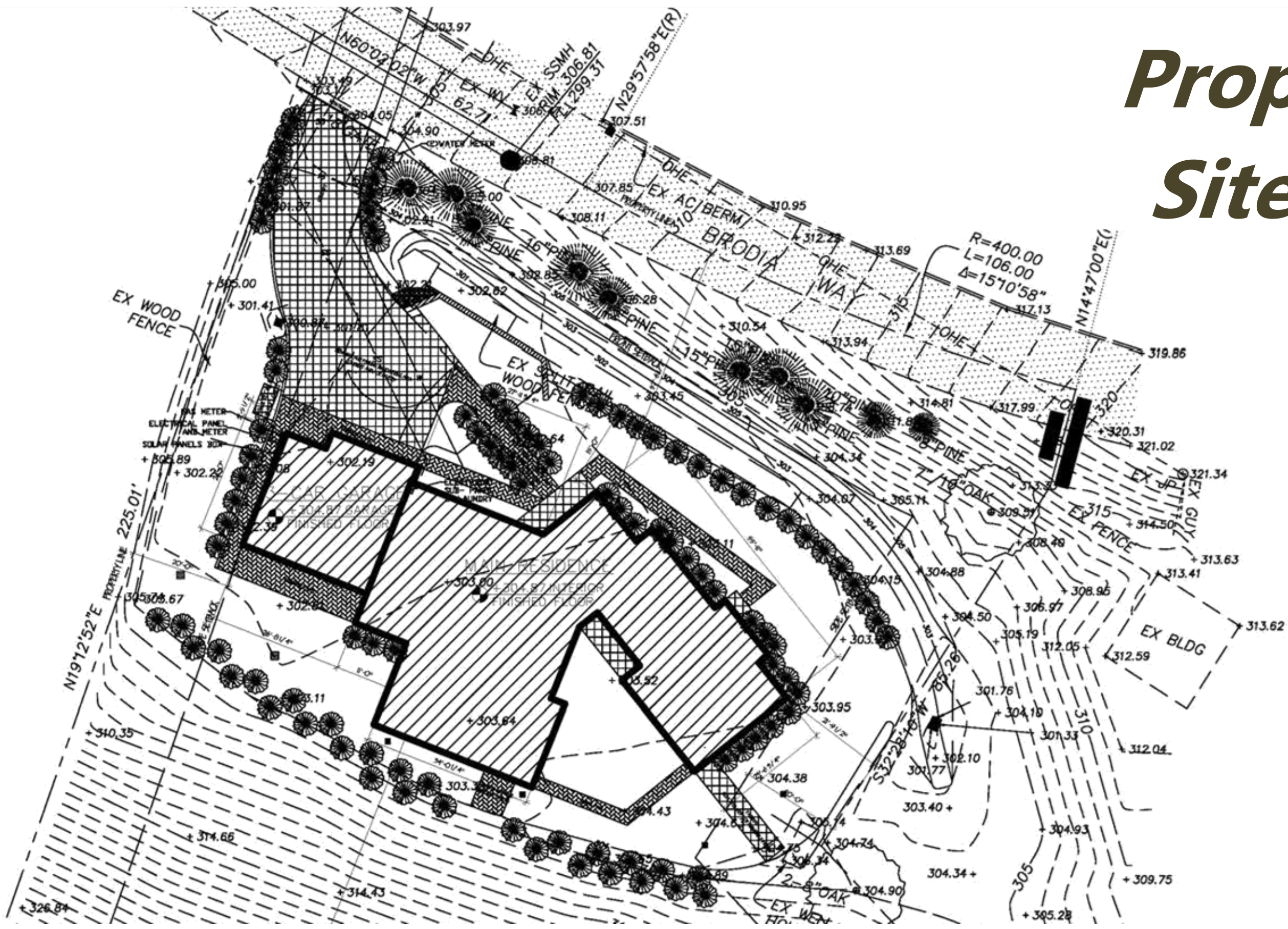



① EAST SIDE*



② WEST SIDE*

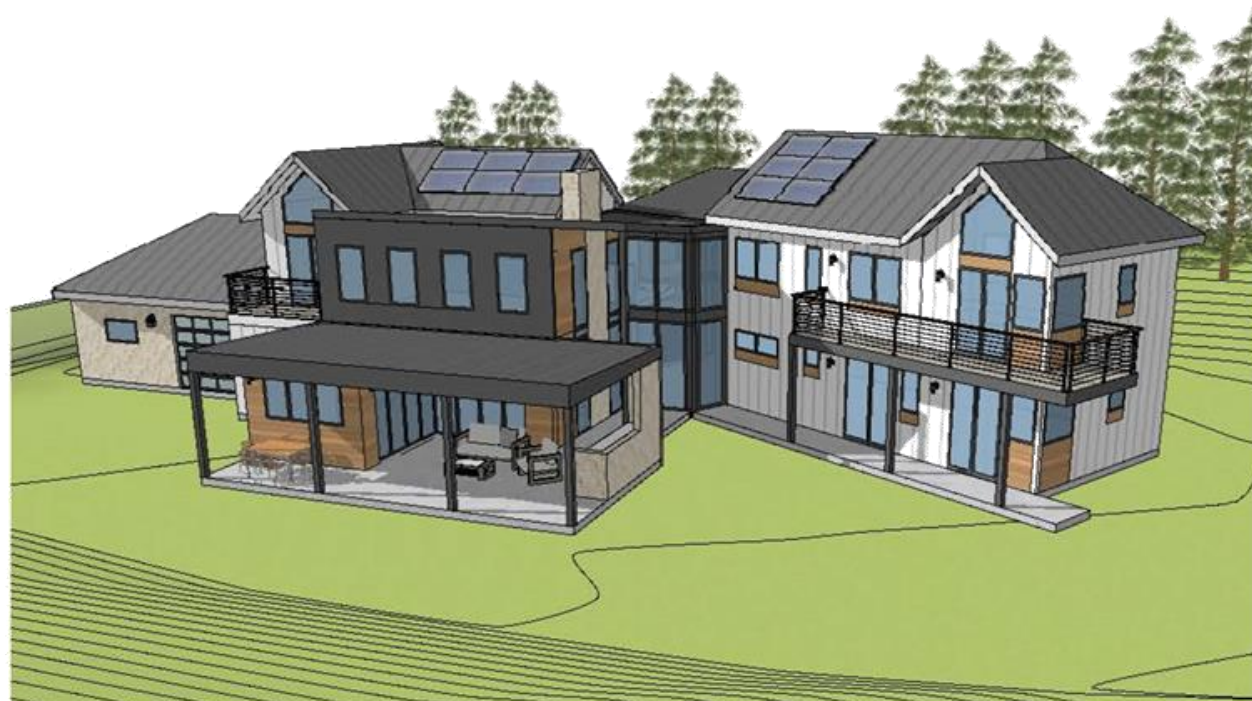

③ SOUTH SIDE*



④ ENTRY COURT FROM BRODIA WAY*

*VIEWS OF HOUSE AND TERRAIN CONCEPTUAL MODEL FOR ILLUSTRATION PURPOSES



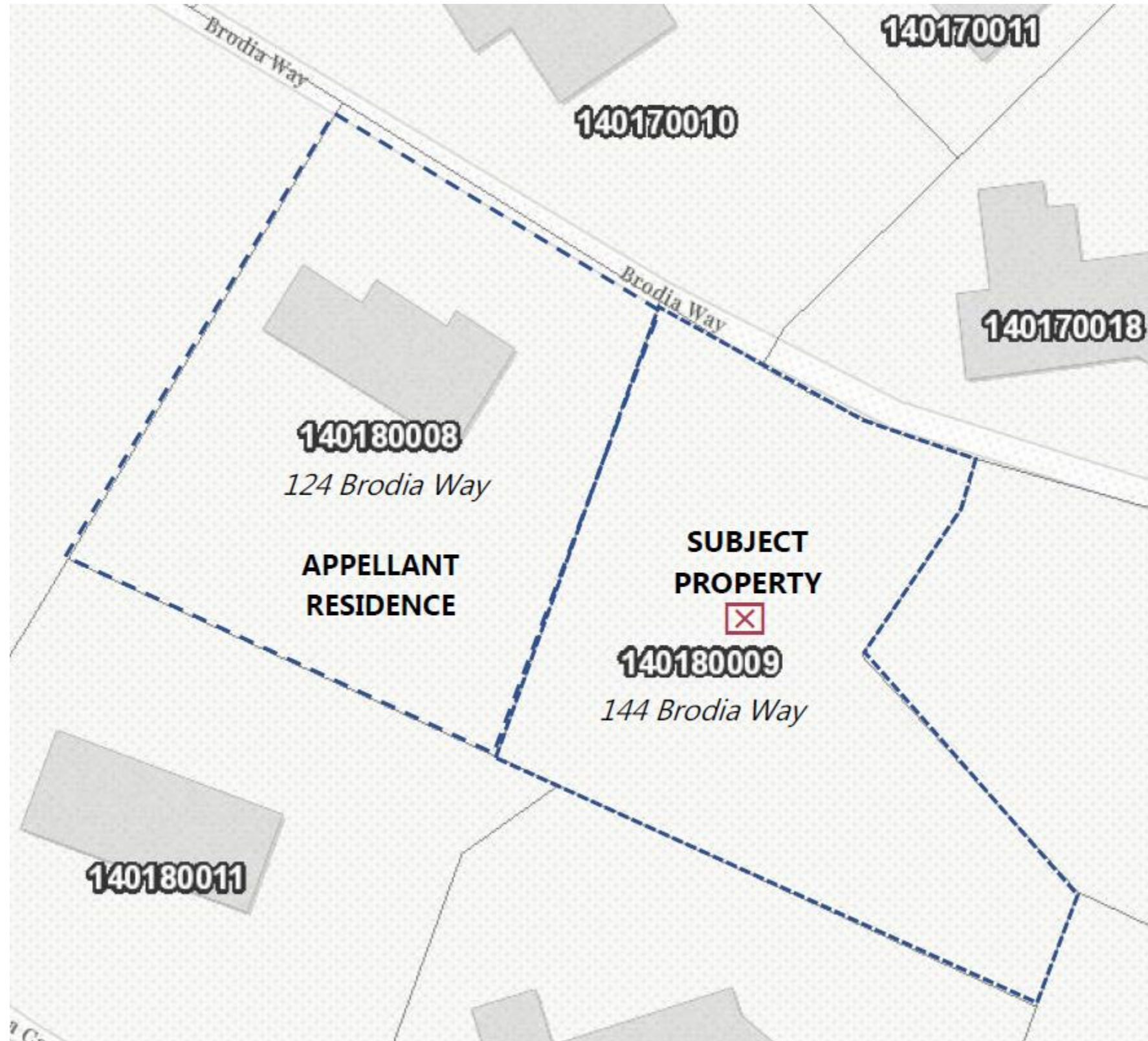

Appeal

Appellant: Ezzat Akbari

Address: 124 Brodia Way

The appellant contends that the subject property has a history of flooding and has the potential to impact his property during winter storms.

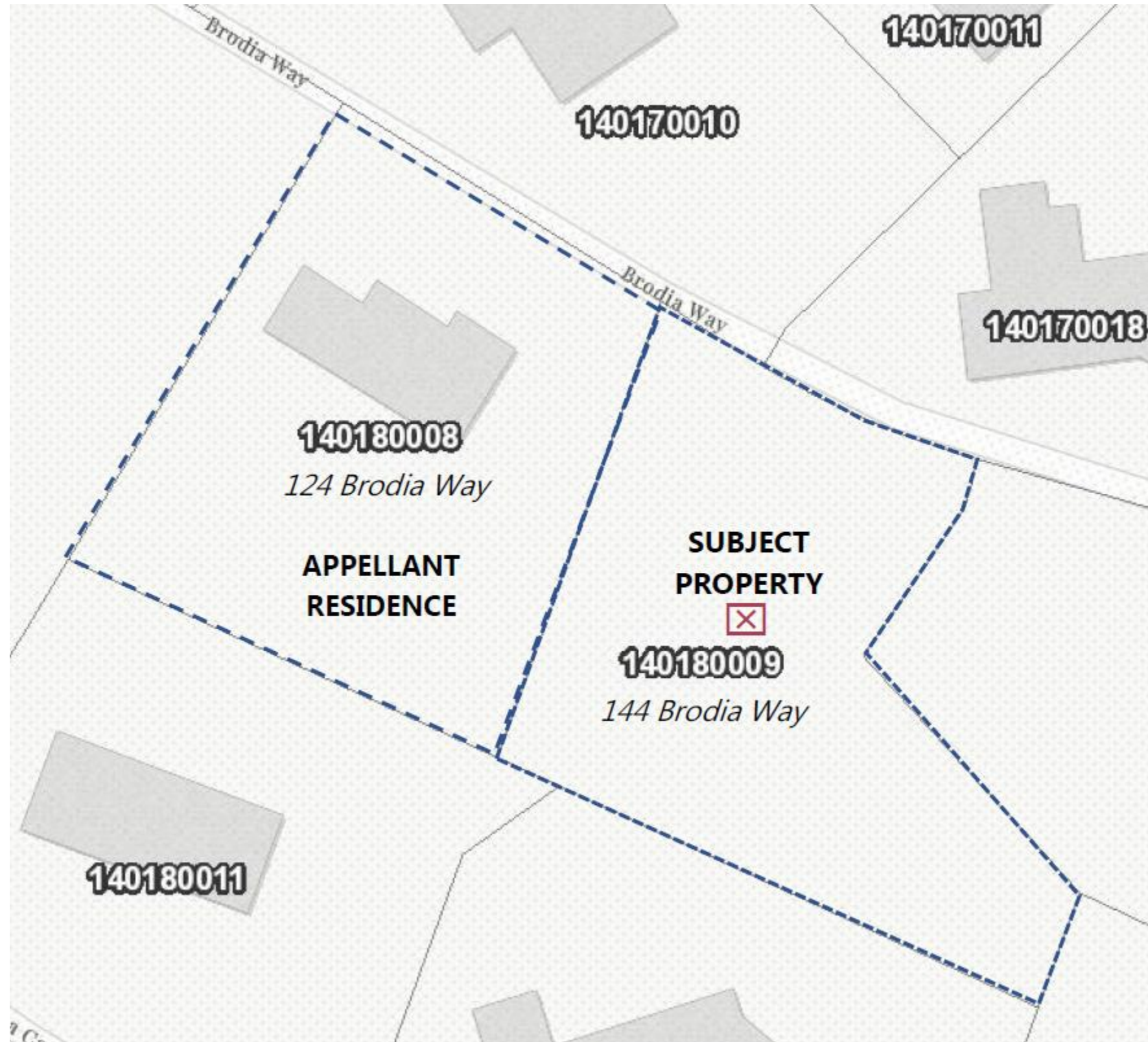

Staff Response

- Prior to Planning submittal, the owner was instructed to acquire a Drainage Permit. He has finalized the process with Public Works and received a draft Flood Control Permit.
- Grading staff provided additional review on the proposed new residence, and the proposed grading work and indicated no concerns regarding run-off.
- In order to ensure all proper measures have been addressed, staff has included Conditions of Approval #9 and #10



Staff Recommendation

1. OPEN the public hearing on an appeal of the County Planning Commission's approval of a tree permit, RECEIVE testimony, and CLOSE the public hearing.
2. DETERMINE that the project is categorically exempt from the California Environmental Quality Act (CEQA), under CEQA Guidelines Section 15303(a) (new construction of one single-family residence).
3. DENY the appeal by Ezzat Akbari.
4. APPROVE a tree permit to work within the dripline of eleven code protected trees for the purpose of constructing a new single-family residence on a vacant lot located at 144 Brodia Way in the unincorporated Walnut Creek area (County File #CDTP21-00031).
5. APPROVE the attached findings and conditions of approval.
6. DIRECT the Department of Conservation and Development to file a Notice of Exemption with the County Clerk



Questions?





LEGEND		ABBREVIATIONS	
---	PROPERTY LINE	SS	SANITARY SEWER
---	LIMIT OF WORK	SD	STORM DRAIN
---	GRADE BREAK	MH	MANHOLE
---	SS	SSCO	SANITARY SEWER CLEANOUT
---	SANITARY SEWER LINE	AD	AREA DRAIN
---	SD	STA.	STATION
---	STORM DRAIN LINE	FL	FLOWLINE
---	W	XING	PIPE CROSSING
---	WATER LINE	B.O.P	BOTTOM OF PIPE
---	RIP RAP	T.O.P	TOP OF PIPE
---	CLEANOUT	EX.	EXISTING
---	AREA DRAIN	C	CONCRETE
---	CHANNEL	TC	TOP OF CURB
---	WALL RAILING TO BE INSTALLED AGAINST DROP OF 30" OR MORE FROM RETAINING WALL.	G	GROUND (LANDSCAPE)
---		TW	TOP OF WALL
---		BW	BOTTOM OF WALL
---		FF	FINISHED FLOOR

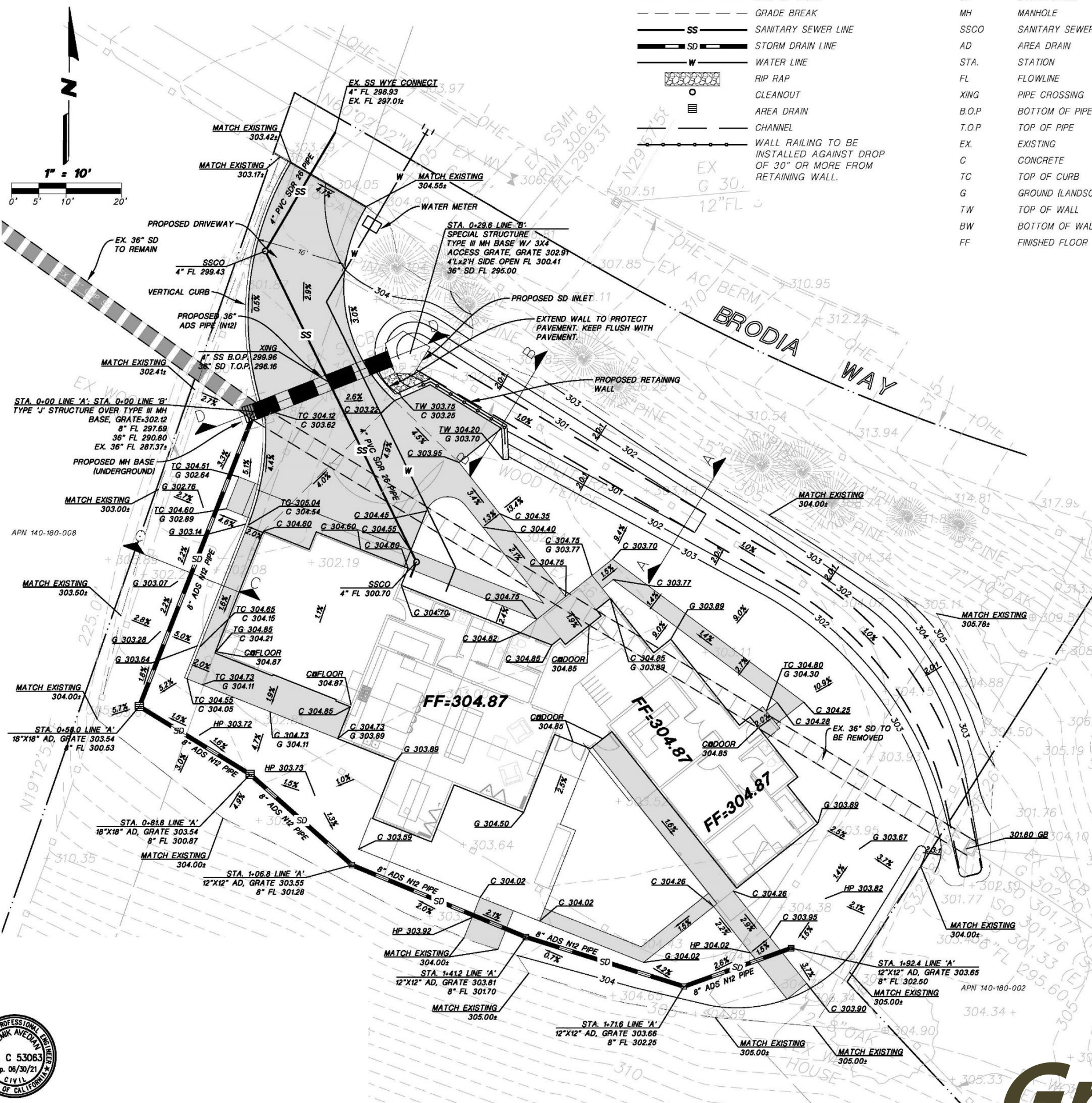
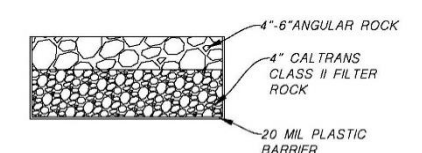
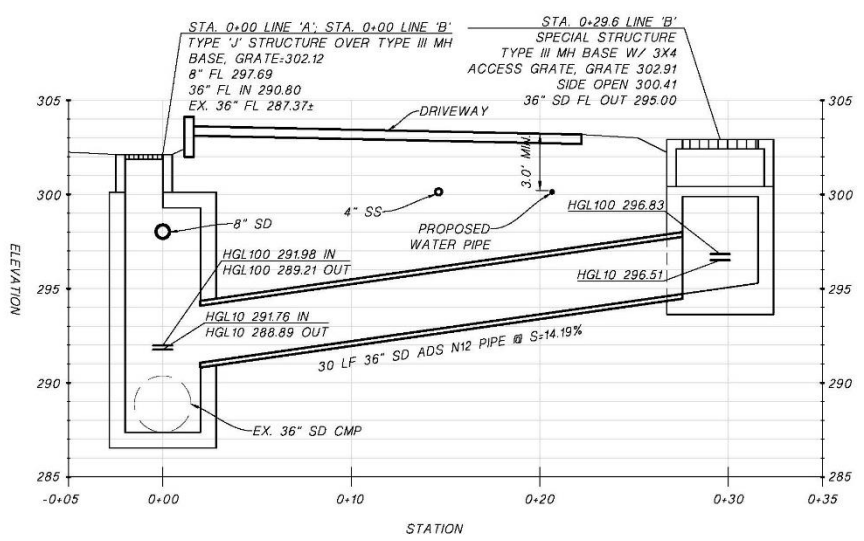
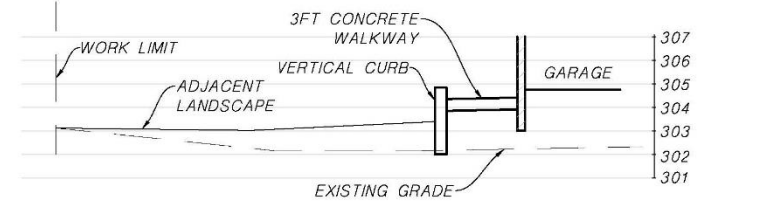
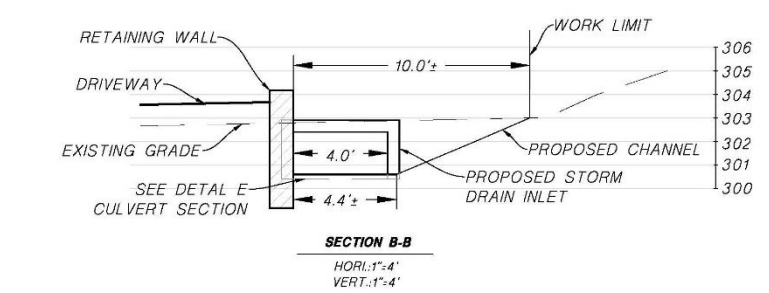
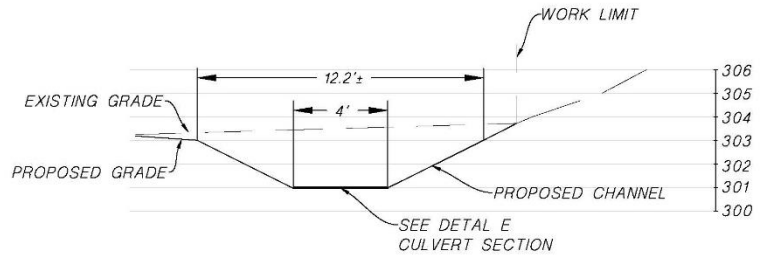

Grading Site Plan



Contra
Costa
County

To: Board of Supervisors
From: Monica Nino, County Administrator
Date: March 8, 2022

Subject: Property Tax Administrative Cost Recovery

RECOMMENDATION(S):

OPEN a public hearing, previously fixed for March 8, 2022 at 9:30 a.m., on implementation of the property tax cost recovery provisions of Revenue and Taxation Code section 95.3;

RECEIVE testimony and CLOSE the public hearing;

ADOPT the report of the Auditor-Controller filed on February 1 of the 2020-2021 fiscal year property tax-related costs of the Assessor, Tax Collector, Auditor, and Assessment Appeals Board, including the proposed charges against each local jurisdiction, excepting school entities, for the local jurisdiction's proportionate share of such administrative costs; and

ADOPT Resolution No. 2021/56 regarding the implementation of the property tax administrative cost recovery provisions of Revenue and Taxation Code section 95.3 for fiscal year 2021-2022.

APPROVE

OTHER

RECOMMENDATION OF CNTY ADMINISTRATOR

RECOMMENDATION OF BOARD COMMITTEE

Action of Board On: **03/08/2022** APPROVED AS RECOMMENDED OTHER

Clerks Notes:

VOTE OF SUPERVISORS

AYE: John Gioia, District I Supervisor
Candace Andersen, District II Supervisor
Diane Burgis, District III Supervisor
Karen Mitchoff, District IV Supervisor
Federal D. Glover, District V Supervisor

I hereby certify that this is a true and correct copy of an action taken and entered on the minutes of the Board of Supervisors on the date shown.

ATTESTED: March 8, 2022
, County Administrator and Clerk of the Board of Supervisors

Contact: Lisa Driscoll, County Finance Director (925) 655-2047

By: June McHuen, Deputy

cc:

RECOMMENDATION(S): (CONT'D)

FISCAL IMPACT:

The fiscal year 2020-2021 net cost of property tax administration was \$17,030,484. This amounts to approximately 0.53% of all 2020-2021 property taxes levied countywide. This cost is allocated to each taxing entity in the County based on net revenues of each entity as a percentage of total revenues. School districts, community college districts, and the County Office of Education are exempt from cost recovery. As a result, the County absorbs the schools' share, which this year amounts to \$8,147,408. The net recovery to the County is \$6,875,075.

Total cost of property tax administration	\$17,030,484
Exempt School share of costs	-\$8,147,408
County share of costs	-\$2,008,001
Net recovery to the County	\$6,875,075

BACKGROUND:

In 1997, the Board adopted Resolution No. 97/129, which provides procedures for property tax administrative cost recovery. The recommended actions are necessary for implementation of Resolution No. 97/129 for the current fiscal year.

CONSEQUENCE OF NEGATIVE ACTION:

The County would not recover \$6,875,075 in property tax administrative costs.

ATTACHMENTS

Resolution 2022/50

Exhibit A: 2021-2022 Property Tax Administration Charges

THE BOARD OF SUPERVISORS OF CONTRA COSTA COUNTY, CALIFORNIA
and for Special Districts, Agencies and Authorities Governed by the Board

Adopted this Resolution on 03/08/2022 by the following vote:

		John Gioia
		Candace Andersen
AYE:	<input checked="" type="checkbox"/>	Diane Burgis
		Karen Mitchoff
		Federal D. Glover
NO:	<input type="checkbox"/>	
ABSENT:	<input type="checkbox"/>	
ABSTAIN:	<input type="checkbox"/>	
RECUSE:	<input type="checkbox"/>	



Resolution No. 2022/50

SUBJECT: Findings and Determination Concerning the Implementation of the Property Tax Administrative Cost Recovery Provisions of Revenue and Taxation Code section 95.3

A public hearing having been held during the Board of Supervisors' meeting of March 8, 2022, on implementation of the property tax cost recovery provisions of Revenue and Taxation Code section 95.3, as provided in Board of Supervisors' Resolution 97/129, the Board of Supervisors, and the Auditor-Controller, hereby make the following findings and determination.

A. PROPERTY TAX ADMINISTRATIVE RECOVERY

1. On February 1, 2022, the Auditor-Controller filed with the Clerk of the Board of Supervisors a report of the 2020-2021 fiscal year property tax-related costs of the Assessor, Tax Collector, Auditor and Assessment Appeals Board, including the applicable administrative overhead costs permitted by federal circular A-87 standards, proportionally attributable to each local jurisdiction and Educational Revenue Augmentation Fund (ERAF) in Contra Costa County, in the ratio of property tax revenue received by each local jurisdiction and ERAF divided by the total property tax revenue received by all local jurisdictions and ERAFs in the county for the current fiscal year. The report included proposed charges against each local jurisdiction excepting school entities, for the local jurisdiction's proportionate share of such administrative costs.
2. On March 8, 2022, at the Board of Supervisors' meeting, a public hearing was held on the Auditor-Controller's report, notice of which was given as required by law and by Board of Supervisors' Resolution No. 97/129.
3. The report of the Auditor-Controller filed on February 1, is hereby adopted, and the Board of Supervisors and the Auditor-Controller find that amounts expressed in said report do not exceed the actual amount of 2020-2021 fiscal year property tax administrative costs proportionally attributable to local jurisdictions.
4. The additional revenue received by Contra Costa County on account of its 2020-2021 fiscal year property tax administrative costs pursuant to Revenue and Taxation Code section 95.3 shall be used only to fund the actual costs of assessing, equalizing, collecting, and allocating property taxes. An equivalent amount of the revenues budgeted to finance assessing, equalizing, collecting and allocating property taxes in fiscal year 2021-2022 may be reallocated to finance other County services. In the event that the actual 2021-2022 costs for assessing, collecting, equalizing and allocating property taxes plus allowable overhead costs are less than the amounts determined in the February 1, 2022 report by the Auditor-Controller, the difference shall be proportionally allocated to the respective local jurisdictions which paid property tax administration charges.

B. FINDINGS AND DETERMINATION

1. No written objections were received by March 8, 2022 for the public hearing on the Auditor-Controller's report filed on February 1, 2022.
2. The property tax administrative costs proportionately attributable to each local jurisdiction for the 2020-2021 fiscal year are as set forth in the Auditor-Controller's report filed on February 1, 2022 attached hereto as Exhibit A.
3. The amounts expressed in the Auditor-Controller's report are correct.

4. Notice as required by law was given of the public hearing on March 8, 2022.
5. The grounds stated herein to support findings are not exclusive and any findings may be supported on any lawful ground, whether or not expressed herein.
6. If any finding herein is held invalid, such invalidity shall not affect findings which can be given effect without the invalid provision, and to this end, the invalid finding is severable.

So found and determined:

Robert Campbell Contra Costa County Auditor-Controller

I hereby certify that this is a true and correct copy of an action taken and entered on the minutes of the Board of Supervisors on the date shown.

**Contact: Lisa Driscoll, County Finance Director (925)
655-2047**

ATTESTED: March 8, 2022
, County Administrator and Clerk of the Board of Supervisors

By: June McHuen, Deputy

cc:

Office of the Auditor-Controller
Contra Costa County

Robert R. Campbell
Auditor-Controller



Harjit S. Nahal
Assistant Auditor-Controller

625 Court Street
Martinez, California 94553-1282
Phone (925) 608-9300
Fax (925) 646-2649

January 24, 2022

TO: Contra Costa County Board of Supervisors
FROM: Robert Campbell, Auditor-Controller 
SUBJECT: **2021-2022 Property Tax Administration Charges**

Commencing with the 1990-91 fiscal year, Revenue and Taxation Code §95.3 (replacing R&T §97.5), provides for the County Auditor-Controller to annually determine property tax administration costs proportionately attributable to incorporated cities and local jurisdictions for fiscal year 1989-90 and thereafter. For purposes of this section, property tax administration costs are the property tax related costs of the Assessor, Tax Collector, County Assessment Appeals Board, and Auditor-Controller, including applicable administrative overhead costs as permitted by Federal OMB Circular A-87 standards.

The following attachments comprise the 2021-22 Property Tax Administration report of the Auditor-Controller pursuant to the County Board of Supervisors' Resolution No. 97/129.

Attachment I summarizes the direct and overhead costs of the Assessor, Tax Collector, Assessment Appeals Board, and Auditor-Controller for the 2020-21 fiscal year. Also included are all offsetting revenues received by the County for providing property tax related services. The 2020-21 net cost of property tax administration was \$17,030,484. This amounts to approximately .53% of all 2020-21 property taxes levied countywide.

Attachment II allocates the \$17,030,484 net cost to each incorporated city and to each local jurisdiction receiving property tax revenues during the 2021-22 fiscal year. This cost allocation to each entity is based on the net revenues of each entity as a percentage of total revenues. School districts, community college districts, and the County Office of Education are exempt from those provisions authorizing County recovery of their proportionate share of property tax administrative costs. As a result, the County absorbs the Schools' share, which, this year, amounts to \$8,147,408.

CONTRA COSTA COUNTY

AUDITOR-CONTROLLER'S REPORT

on

2021-2022 Property Tax Administration Charges

Table of Contents

Attachment I

- 3 Summary Calculations
- 4 Assessor's Department
- 5 Treasurer-Tax Collector's Department
- 6 Auditor-Controller's Department
- 7 Assessment Appeals Board
- 8 Federal A-87 Overhead Allocation
- 9 Revenue Offsets

Attachment II

- 10 Administrative Cost Allocation

CONTRA COSTA COUNTY**2021-2022 Property Tax Administration Charges****SUMMARY CALCULATIONS**

NOTE: Per Revenue and Taxation Code Section 95.3, the property tax administration fee to be charged in the 2021-22 Fiscal Year shall be based on the 2020-21 property tax related costs of the Assessor, Tax Collector, Auditor-Controller, and Assessment Appeals Board including applicable overhead costs as permitted by Federal Circular A-87 standards.

Property Tax Related Cost:

Assessor	\$ 16,096,833	
Tax Collector	4,202,141	
Auditor-Controller	1,400,605	
Assessment Appeals Board	<u>96,736</u>	
Total		\$ 21,796,315

Overhead Cost per Circular A-87:

Assessor	1,869,066	
Tax Collector	729,152	
Auditor-Controller	<u>237,411</u>	
Total		2,835,629

Less: Fees Received for Property Tax Related Services:

County General	3,752,281	
Assessor	436,903	
Tax Collector	2,306,248	
Auditor-Controller	<u>1,106,028</u>	
Total		<u>7,601,460</u>

**Net Property Tax Administration Cost,
2021-2022 Fiscal Year**

\$ 17,030,484

CONTRA COSTA COUNTY

2021-2022 Property Tax Administration Charges

ASSESSOR'S DEPARTMENT

<u>DIRECT AND INDIRECT DEPARTMENTAL COST</u>	<u>ACTUAL 2020-2021</u>
Salaries & Employee Benefits	\$ 13,732,725
Services & Supplies	<u>2,613,914</u>
Gross Cost	16,346,639
LESS:	
** Intrafund Transfers	<u>249,806</u>
TOTAL ASSESSOR COST	16,096,833
LESS: ASSESSOR REVENUE OFFSETS	<u>436,903</u>
NET ASSESSOR DEPARTMENT COST	<u>\$ 15,659,930</u>

** Costs are related to preparing maps for LAFCO and County GIS related expenses.

CONTRA COSTA COUNTY
2021-2022 Property Tax Administration Charges
TREASURER-TAX COLLECTOR'S DEPARTMENT

<u>DIRECT AND INDIRECT DEPARTMENTAL COST</u>	<u>ACTUAL 2020-2021</u>
Salaries & Employee Benefits	\$ 3,796,520
Services & Supplies	1,695,221
Other Charges	6,540
Gross Cost	5,498,281
LESS:	
Intrafund Transfers	(2,985)
Treasury Function Costs	1,053,869
Business License Program	245,256
TOTAL TAX COLLECTOR COST	4,202,141
LESS: TAX COLLECTOR REVENUE OFFSETS	2,306,248
NET TAX COLLECTOR COST	\$ 1,895,893

*Capital asset costs included in the A-87 allocation are excluded from direct costs.

CONTRA COSTA COUNTY
2021-2022 Property Tax Administration Charges
AUDITOR-CONTROLLER'S DEPARTMENT

<u>PROPERTY TAX FUNCTION - DIRECT AND INDIRECT DEPARTMENT COSTS</u>	<u>ACTUAL 2020-2021</u>
Salaries & Employee Benefits	\$ 750,984
Information Technology Costs	520,325
Legal Fees	12,782
Other Services and Supplies	(25,206)
Accounts Payable - Supplemental & Other Tax Refunds	6,609
Department Overhead Allocation	<u>135,111</u>
TOTAL PROPERTY TAX FUNCTION COSTS	1,400,605
 LESS: TOTAL PROPERTY TAX FUNCTION REVENUE OFFSETS	 <u>1,106,028</u>
 NET AUDITOR-CONTROLLER COST	 <u>\$ 294,577</u>

CONTRA COSTA COUNTY
2021-2022 Property Tax Administration Charges
ASSESSMENT APPEALS BOARD

<u>DIRECT AND INDIRECT COSTS</u>	<u>ACTUAL</u> <u>2020-2021</u>
Clerk of the Board	\$ 76,070
Assessment Appeals Board - allowances and postage	7,738
County Counsel	<u>12,928</u>
TOTAL ASSESSMENT APPEALS BOARD COST	<u><u>\$ 96,736</u></u>

CONTRA COSTA COUNTY
2021-2022 Property Tax Administration Charges
FEDERAL A-87 OVERHEAD ALLOCATION

<u>Department</u>	A-87 Plan 2020-2021 <u>Actual</u>	Percent Property Tax <u>Related</u>	<u>Net to Allocate</u>
Assessor	\$ 1,869,066	100%	\$ 1,869,066
Tax Collector	959,411	76%	729,152
Auditor-Controller(Tax Division)	<u>237,411</u>	100%	<u>237,411</u>
TOTALS	<u><u>\$ 3,065,888</u></u>		<u><u>\$ 2,835,629</u></u>

CONTRA COSTA COUNTY
2021-2022 Property Tax Administration Charges

REVENUE OFFSETS

County General

0005	9608 Supplemental Tax Administration Fees	\$ 3,752,281	
			\$ 3,752,281

Assessor

0016	1600 Administration	877,310	
	1600 Excludable Revenues (Direct credits and non-property tax related revenues)	(730,000)	
0016	1605 Drafting	8,545	
	1647 Roll Maintenance	<u>281,048</u>	
			436,903

Tax Collector

0015	Tax Collector Revenue	3,265,180	
	Excludable Revenues (Direct credits and non-property tax related revenues)	<u>(958,932)</u>	
			2,306,248

Auditor-Controller

0010	1004 Tax & Cost Accounting Division Revenue	1,523,575	
	Excludable Revenues (Direct credits and non-property tax related revenues)	<u>(417,547)</u>	
			<u>1,106,028</u>

TOTAL REVENUE OFFSETS

\$ 7,601,460

CONTRA COSTA COUNTY
2021-2022 ADMINISTRATIVE COST ALLOCATION

Fund No	Jurisdiction	Adjusted	2021-2022	2021-2022	Net Revenue	2021-2022	Adj Allocation Factors	Allocation	
		2021-2022 AB 8 Allocation	Unitary Allocation	Pass-thru H&S 33676		Revenue		2021-2022 Adj Allocation Factors	to Allocate
		(1)	(2)	(3)	(4)	(5)		(6)	(6)
1003	County General	\$ 272,297,929	6,870,064	404,228	\$ 279,572,221	0.1179058801027	\$	17,030,484	2,008,001
COUNTY GOVERNED SPECIAL DISTRICTS									
1206	County Library	31,107,392	455,364	41,476	31,604,232	0.0133286662436		226,994	
2135	West CCC Healthcare	4,046,853	59,188	0	4,106,041	0.0017316685168		29,491	
2020	Contra Costa Fire	128,913,193	1,342,111	103,515	130,358,819	0.0549771045770		936,287	
2028	Crockett Carquinez Fire	640,252	10,162	0	650,414	0.0002743032889		4,672	
3060	East Contra Costa Fire	16,108,819	113,002	0	16,221,821	0.0068413380310		116,511	
2401	Service Area L-100	1,075,935	17,669	39,759	1,133,363	0.0004779806267		8,140	
2470	Service Area M-1	67,448	1,266	0	68,714	0.0000289790546		494	
2475	Service Area M-29	(711)	1,026	0	315	0.0000001327712		2	
2488	Service Area M-16 Clyde	33,710	296	0	34,006	0.0000143416010		244	
2489	Service Area M-17 Montalvin	213,882	2,172	0	216,054	0.0000911177854		1,552	
2492	Service Area M-20 Rodeo	13,839	146	0	13,985	0.0000068981192		100	
2494	Svc Area RD4 Bethel Isle	7,571	399	0	7,970	0.0000033614148		57	
2496	Svc Area M23 Blackhawk	2,461,629	21,170	0	2,482,799	0.0010470877857		17,832	
2505	Flood Control CCC Water	3,856,114	57,499	4,867	3,918,480	0.0016525668464		28,144	
2520	Flood Control Zone 3B	6,564,002	69,652	0	6,633,654	0.0027976556421		47,645	
2521	Flood Cont Z1 Marsh Crk	2,572,723	19,948	0	2,592,671	0.0010934247954		18,622	
2527	Flood Control Zone 7	70,619	1,233	2,935	74,787	0.0000315406246		537	
2530	Flood Control Zone 8	21,602	454	0	22,056	0.0000093017035		158	
2531	Flood Control Zone 8A	27,868	402	0	28,270	0.0000119223672		203	
2550	Flood Cont Drainage 290	2,530	27	0	2,557	0.0000010782965		18	
2551	Flood Cont Drainage 300	5,715	94	0	5,809	0.0000024497591		42	
2552	Flood Cont Drainage A13	410,353	3,209	0	413,562	0.0001744142140		2,970	
2554	Flood Cont Drainage 10	445,491	3,319	0	448,810	0.0001892797682		3,224	

**CONTRA COSTA COUNTY
2021-2022 ADMINISTRATIVE COST ALLOCATION**

Fund No	Jurisdiction	Adjusted	2021-2022	2021-2022	Net Revenue	2021-2022	\$	to Allocate
		2021-2022 AB 8 Allocation	Unitary Allocation	Pass-thru H&S 33676		Adj Allocation Factors		
		(1)	(2)	(3)	(4)	(5)	17,030,484	(6)
2563	Flood Cont Drainage 127	16,178	231	0	16,409	0.0000069203121		118
2583	Flood Cont Drainage 16	100,820	819	0	101,639	0.0000428650239		730
2652	S/A Pl 2 Danville	504	93	0	597	0.0000002517262		4
2653	S/A Pl-2 Zone A	165,053	1,401	0	166,454	0.0000701999083		1,196
2655	S/A Pl 5 Round Hill	292,619	2,795	0	295,414	0.0001245871176		2,122
2656	S/A Police-6	4,660,086	1,122,489	0	5,782,575	0.0024387242192		41,533
2657	S/A Pl-2 Zone B	235,784	2,220	0	238,004	0.0001003751391		1,709
2702	S/A Lib-2 El Sobrante	140,898	2,241	0	143,139	0.0000603669051		1,028
2710	S/A Lib-10 Pinole	1,414	19	0	1,433	0.0000006044922		10
2712	S/A Lib-12 Moraga	11,636	332	0	11,968	0.0000050474129		86
2713	S/A Lib-13 Ygnacio	173,811	1,651	0	175,462	0.0000739988413		1,260
2751	Svc Area R-4 Moraga	33,982	1,055	0	35,037	0.0000147763146		252
2758	Svc Area R-7 Zone A	1,368,142	12,289	0	1,380,431	0.0005821785522		9,915
2825	Co Co Co Water Agency	731,428	20,027	1,250	752,705	0.0003174432303		5,406
								<u>1,509,308</u>
AUTONOMOUS SPECIAL DISTRICTS								
3005	San Ramon Valley Fire	80,065,601	1,021,058	407,206	81,493,865	0.0343689578022		585,320
3007	Kensington Fire	4,645,995	31,769	0	4,677,764	0.0019727849611		33,597
3011	Rodeo-Hercules Fire	3,333,792	64,862	0	3,398,654	0.0014333372910		24,410
3074	Moraga-Orinda Fire District	28,073,743	219,378	0	28,293,121	0.0119322489981		203,212
3102	Co Co Resource Cons	315,717	4,888	1,158	321,763	0.0001356990755		2,311
3255	Kensington Community Svc	2,091,133	15,054	0	2,106,187	0.0008882562850		15,127
3260	Diablo Community Svc	517,432	3,688	0	521,120	0.0002197755990		3,743
3301	CCC Mosquito Abate Dst1	6,079,973	96,360	2,186	6,178,519	0.0026057083932		44,376
3406	Central CC Sanitary	19,905,632	290,562	49,609	20,245,803	0.0085383993403		145,413
3409	Mt View Sanitary	445,054	9,796	0	454,850	0.0001918271383		3,267

CONTRA COSTA COUNTY
2021-2022 ADMINISTRATIVE COST ALLOCATION

Fund No	Jurisdiction	Adjusted	2021-2022	2021-2022	Net Revenue	2021-2022	Adj Allocation Factors	\$	to Allocate
		2021-2022 AB 8 Allocation	Unitary Allocation	Pass-thru H&S 33676		(5)			
3411	Ironhouse Sanitary	(1) 341,194	5,587	0	346,781	0.0001462502374		17,030,484	2,491
3414	Rodeo Sanitary	293,220	5,150	0	298,370	0.0001258335311			2,143
3416	West Co Wastewater	1,368,798	18,408	6,831	1,394,037	0.0005879166223			10,013
3418	Stiege Sanitary	533,365	5,670	0	539,035	0.0002273306713			3,872
3422	Byron Sanitary	46,742	812	0	47,554	0.0000200551682			342
3240	Crockett-Valona Sanitary	418,014	9,587	0	427,601	0.0001803352546			3,071
3430	Twn of Discovery Bay (Comm Svc Dist)	739,352	6,565	0	745,917	0.0003145807174			5,357
3480	Delta Diablo Z1 W Pittsburg	371,392	13,016	97,223	481,631	0.0002031213834			3,459
3481	Delta Diablo Z2 Pittsburg	554,360	6,116	77	560,553	0.0002364057545			4,026
3482	Delta Diablo Z3 Antioch	1,454,752	17,554	0	1,472,306	0.0006209254138			10,575
3515	Los Medanos Healthcare	878,140	97,558	26,091	1,001,789	0.0004224913518			7,195
3520	Mt Diablo Healthcare	349,149	2,403	0	351,552	0.0001482622127			2,525
3601	Alamo-Lafayette Cemetery	384,039	3,906	0	387,945	0.0001636107060			2,786
3603	B B K Union Cemetery	738,386	7,475	0	745,861	0.0003145568990			5,357
3700	Ambrose Rec & Park	532,636	15,590	81,295	629,521	0.0002654922086			4,521
3715	Green Valley Rec & Park	68,569	520	0	69,089	0.0000291374842			496
3735	Pleasant Hill Rec & Park	4,119,489	48,916	1,163	4,169,568	0.0017584601915			29,947
3770	Bethel Isle Muni Imp	629,909	8,370	0	638,279	0.0002691855387			4,584
3803	Co Co Co Water	3,278,894	92,425	6,643	3,377,962	0.0014246105286			24,262
3830	Castile Rock Co Water	17,310	142	0	17,452	0.0000073603480			125
4001	East Bay Muni Utility	17,128,660	220,097	65,806	17,414,563	0.0073443611371			125,078
4002	EBMUD Special District 1	498,722	4,333	0	503,055	0.0002121566167			3,613
4007	A-C Transit Spec District 1	9,986,260	134,127	0	10,120,387	0.0042681392827			72,688
4009	BART	13,900,456	203,774	22,463	14,126,693	0.0059577457707			101,463
4010	Bay Area Air Management	4,051,776	59,402	0	4,111,178	0.0017338346495			29,528
4025	Dublin San Ramon Svcs	811,554	3,199	0	814,753	0.0003436113715			5,852
4026	East Bay Regional Park	58,945,033	907,558	53,702	59,906,293	0.0252646855683			430,270

**CONTRA COSTA COUNTY
2021-2022 ADMINISTRATIVE COST ALLOCATION**

Fund No	Jurisdiction	Adjusted	2021-2022	2021-2022	2021-2022	Net Revenue	2021-2022	\$	17,030,484	to	Allocate
		2021-2022 AB 8 Allocation	Unitary Allocation	Pass-thru H&S 33676	Adj Allocation Factors						
		(1)	(2)	(3)		(4)	(5)				(6)
4110	Reclamation Dist 800 Exp	1,028,396	10,285	0	1,038,681	0.0004380499923					7,460
4111	Discovery Bay Rec/Drain	58,716	573	0	59,289	0.0000250044472					426
4180	East Co Co Irrigation	3,872,540	32,860	0	3,905,400	0.0016470507616					28,050
4181	Byron-Bethany Irrigation	400,883	11,689	0	412,572	0.0001739967157					2,963
CITIES & CITY SPECIAL DISTRICTS											1,995,314
4201	City of Clayton	1,093,406	15,770	73,505	1,182,681	0.0004987798567					8,494
4202	City of Concord	17,576,999	237,961	0	17,814,960	0.0075132234483					127,954
4203	City of Brentwood	12,823,871	83,871	29,574	12,937,316	0.0054561417960					92,921
4204	City of San Pablo	350,779	13,037	0	363,816	0.0001534346663					2,613
4205	City of El Cerrito	9,472,764	95,816	0	9,568,580	0.0040354218775					68,725
4206	City of Walnut Creek	19,572,619	238,163	0	19,810,782	0.0083549350182					142,289
4207	City of Pleasant Hill	3,713,306	29,637	0	3,742,943	0.0015785365393					26,883
4208	City of Martinez	10,075,633	138,223	0	10,213,856	0.0043075584685					73,360
4209	City of Antioch	13,431,284	164,691	0	13,595,975	0.0057339221315					97,651
4210	City of Pittsburg	4,327,300	62,932	0	4,390,232	0.0018515223690					31,532
4211	City of Hercules	1,397,526	35,380	0	1,432,906	0.0006043089858					10,292
4212	City of Pinole	2,840,690	32,914	0	2,873,604	0.0012119042329					20,639
4213	Richmond Tax District 1	26,351,509	525,776	0	26,877,285	0.01133351390418					193,043
4214	City of Lafayette	5,725,183	37,733	0	5,762,916	0.0024304333639					41,391
4215	Town of Moraga	2,599,641	28,276	0	2,627,917	0.0011082892319					18,875
4216	Town of Danville	11,302,267	99,164	0	11,401,431	0.0048084024103					81,889
4217	City of San Ramon	17,997,685	336,580	0	18,334,265	0.0077322332029					131,684
4218	City of Orinda	6,016,739	58,965	0	6,075,704	0.0025623477527					43,638
4219	City of Oakley	3,333,730	20,263	46,529	3,400,522	0.0014341253062					24,424
4227	Richmond Tax District 3	10,854,552	125,675	0	10,980,227	0.0046307653051					78,864
4230	Richmond Sewer 1	232,584	4,401	0	236,985	0.0000999454020					1,702

CONTRA COSTA COUNTY
2021-2022 ADMINISTRATIVE COST ALLOCATION

Fund No	Jurisdiction	Adjusted 2021-2022 AB 8 Allocation	2021-2022 Unitary Allocation	2021-2022 Pass-thru H&S 33676	Net Revenue	2021-2022 Adj/Allocation Factors	\$ to Allocate
		(1)	(2)	(3)	(4)	(5)	(6)
4231	Brentwood Rec & Park District	2,580,414	15,906	0	2,596,320	0.0010949636200	18,648
4232	San Ramon M-29	3,856,151	14,268	0	3,870,419	0.0016322979040	27,799
4240	Pleasant Hill Lgt Dist 1	630,564	5,391	0	635,955	0.0002682056080	4,568
4241	Svc Area R-8 Walnut Creek	788,725	7,698	0	796,423	0.0003358808568	5,720
4248	Clayton Light Mlce 1	42,972	461	0	43,433	0.0000183172501	312
4252	Martinez Pine Ridge Mlce	8,623	91	0	8,714	0.0000036748960	63
4253	Martinez Parking District 1	83,538	703	0	84,241	0.0000355275805	605
4263	Lafayette Core Area Mlc	65,706	2,703	0	68,409	0.0000288504966	491
4264	Lafayette St Lt Mlce Z1	10,620	87	0	10,707	0.0000045156071	77
4271	Concord Vly Terr SltMlc	3,274	44	0	3,318	0.0000013992171	24
4272	Concord Kirkwood Mlce 1	67,908	608	0	68,516	0.0000288959050	492
4274	Concord Blhn Terr St Lt	877	16	0	893	0.00000003766995	6
4275	Pl Hill-Diablo Vista Wtr	254,562	1,957	0	256,519	0.0001081835149	1,842
4280	Antioch Parking Mlce 1A	48,942	473	0	49,415	0.0000208402565	355
4285	Moraga St Lt Mlce 1	194,588	1,466	0	196,054	0.0000826830083	1,408
4294	Oakley Police Services	580,996	2,436	0	583,432	0.0002460547877	4,190
REDEVELOPMENT SUCCESSOR AGENCIES							1,385,463
4701	Antioch	5,296,819	147,407	0	5,444,226	.0022960303866	39,103
4702	Antioch Project 2	1,205,322	7,353	0	1,212,675	.0005114294204	8,710
4703	Antioch Project 3	49,122	481	(16,618)	32,985	.0000139109235	237
4704	Antioch Project 4	1,015,627	10,391	(63,753)	962,265	.0004058225399	6,911
4705	Antioch Project 4, Amd 1	820,098	4,623	(27,714)	797,007	.0003361270751	5,724
4706	Brentwood Project	3,219,245	29,087	0	3,248,332	.0013699410930	23,331
4707	Brentwood Amendment 1	945,396	11,518	0	956,914	.0004035656916	6,873
4708	North Brentwood	6,913,907	26,720	(32,072)	6,908,555	.0029135913701	49,620
4709	North Brtwd Amdnd 2	404,302	1,575	0	405,877	.0001711733021	2,915

CONTRA COSTA COUNTY
2021-2022 ADMINISTRATIVE COST ALLOCATION

Fund No	Jurisdiction	Adjusted 2021-2022 AB 8 Allocation	2021-2022 Unitary Allocation	2021-2022 Pass-thru H&S 33676	Net Revenue	2021-2022 Adj Allocation Factors	\$ 17,030,484 to Allocate
		(1)	(2)	(3)	(4)	(5)	(6)
4710	Central Concord	22,688,898	879,122	0	23,568,020	.00993935002127	169,274
4711	Concord Commerce	809,130	10,750	0	819,880	.0003457737255	5,889
4712	Cent Concord RDA Amnd	1,612,381	3,710	0	1,616,091	.0006815648620	11,607
4714	Clayton	8,410,841	47,728	(140,029)	8,318,540	.0035082339978	59,747
4716	Hercules Dynamite	11,048,559	75,559	0	11,124,118	.0046914493562	79,898
4717	Hercules RDA Proj 2	6,210,141	30,866	0	6,241,007	.0026320620607	44,825
4720	El Cerrito	9,266,525	86,595	0	9,353,120	.0039445454910	67,178
4721	El Cerrito Area II	1,987	92	0	2,079	.0000008768034	15
4725	Pinole Vista	8,256,683	92,779	0	8,349,462	.0035212748699	59,969
4726	Pinole Vista 81	5,621,824	48,500	0	5,670,324	.0023913839062	40,726
4728	Oakley RDA Proj 2	795,001	939	0	795,940	.0003356770609	5,717
4730	Pittsburg Marina	0	1,373	0	1,373	.0000005789686	10
4731	Pittsburg Riverside	584,404	7,498	0	591,902	.0002496269697	4,251
4732	Pittsburg Neighborhood I	1,573,139	13,878	0	1,587,017	.0006693032877	11,399
4733	Pittsburg Neighborhood II	721,447	7,827	0	729,274	.0003075617189	5,238
4734	Pittsburg/Los Medanos I	32,601,801	438,781	0	33,040,582	.0139344277920	237,310
4735	Pittsburg/Los Medanos II	4,407,786	74,478	0	4,482,264	.0018903354601	32,193
4736	Pittsburg/Los Medanos III	16,878,154	76,380	0	16,954,534	.0071503500140	121,774
4737	Richmd 8A RDA 2000 Amnd	1,990,208	8,113	0	1,998,321	.0008427655491	14,353
4738	Richmd 10A RDA 2000 Amnd	1,322,517	4,295	0	1,326,812	.0005595654494	9,530
4739	Richmd 1A RDA 2000 Amnd	222,000	796	0	222,796	.0000939614045	1,600
4740	Richmond 1A	674,799	11,935	0	686,734	.0002896210502	4,932
4741	Richmond 8A	1,146,473	10,539	0	1,157,012	.0004879543930	8,310
4742	Richmond 10A	1,121,583	23,638	0	1,145,221	.0004829816950	8,225
4743	Richmond 10B	127,769	3,146	0	130,915	.0000552117975	940
4744	Richmond 11A	16,847,290	102,798	0	16,950,088	.0071484751749	121,742
4745	Richmond 12A	165,456	1,802	0	167,258	.0000705388581	1,201

CONTRA COSTA COUNTY
2021-2022 ADMINISTRATIVE COST ALLOCATION

Fund No	Jurisdiction	Adjusted 2021-2022 AB 8 Allocation	2021-2022 Unitary Allocation	2021-2022 Pass-thru H&S 33676	Net Revenue	2021-2022 Adj Allocation Factors	\$ to Allocate
		(1)	(2)	(3)	(4)	(5)	(6)
4746	Richmond 8A Henley	73,202	786	0	73,988	.0000312035262	531
4747	Richmond 1B	200,441	1,086	0	201,527	.0000849912199	1,447
4748	Richmond 1C-Potero	1,607,251	9,727	0	1,616,978	.0006819390184	11,614
4749	Richmond 3A	1,586,561	8,043	0	1,594,604	.0006725031858	11,453
4750	Walnut Creek-So Broadway	1,629,017	13,629	0	1,642,646	.0006927643766	11,798
4751	Walnut Creek-Mt Diablo	0	14,232	0	14,232	.0000060021026	102
4752	Richmd 6A RDA 2000 Amnd	82,175	283	0	82,458	.0000347756913	592
4753	Richmd 10B RDA 2000 Amnd	27,765	167	0	27,932	.0000117800817	201
4754	Richmond 6-A Amend 1	1,378,945	2,259	0	1,381,204	.0005825045758	9,920
4755	Richmond 6-A	592,036	4,716	0	596,752	.0002516723128	4,286
4756	Danville Downtown	5,482,081	38,861	(411,995)	5,108,947	.0021546308937	36,694
4757	Richmd 11A RDA 2000 Amnd	535,171	1,520	0	536,691	.0002263422216	3,855
4758	Richmd 10B RDA 2006 Amnd	7,220,930	18,032	0	7,238,962	.0030529363304	51,993
4760	San Pablo-So Entrance	744,687	8,005	0	752,692	.0003174377098	5,406
4761	San Pablo-El Portal	3,688,641	50,437	0	3,739,078	.0015769066575	26,855
4762	San Pablo-El Portal 79	4,873,714	56,557	0	4,930,271	.0020792763290	35,411
4763	San Pablo-Oak Park	1,197,333	12,121	0	1,209,454	.0005100712551	8,687
4764	San Pablo-Sheffield	548,808	5,602	0	554,410	.0002338151522	3,982
4765	San Pablo-Bayview	2,792,974	24,599	0	2,817,573	.0011882739179	20,237
4766	San Pablo-El Portal 80	1,990,825	27,201	0	2,018,026	.0008510756272	14,494
4767	San Pablo-Oak Park 79	61,469	659	0	62,128	.0000262017072	446
4768	San Pablo-Bayview 80	126,280	950	0	127,230	.0000536577439	914
4769	San Pablo-Legacy RDA	2,685,317	10,606	0	2,695,923	.0011369696042	19,363
4770	Pleasant Hill Commons	4,185,233	32,353	0	4,217,586	.0017787112143	30,292
4771	Pleasant Hill Commons 1A	156,188	1,301	0	157,489	.0000664190425	1,131
4772	Plsnt Hill Schoolyrd Anx	1,289,355	9,927	0	1,299,282	.0005479548468	9,332
4773	Plsnt Hill Comm 2001 Amnd	1,227,820	4,954	0	1,232,774	.0005199060676	8,854

CONTRA COSTA COUNTY
2021-2022 ADMINISTRATIVE COST ALLOCATION

Fund No	Jurisdiction	Adjusted 2021-2022 AB 8 Allocation	2021-2022 Unitary Allocation	2021-2022 Pass-thru H&S 33676	Net Revenue	2021-2022 Adj Allocation Factors	\$	to Allocate
		(1)	(2)	(3)	(4)	(5)	17,030,484	(6)
4774	Pleasant Hill Commons 2009 Amd	146,592	100	0	146,692	.0000618654623		1,054
4775	Lafayette RDA	10,123,320	31,767	0	10,155,087	.0042827732274		72,938
4777	San Ramon	13,656,161	74,367	(1,186,403)	12,544,125	.0052903185241		90,097
4780	CoCoCo Pleasant Hill BART	11,274,879	68,528	0	11,343,407	.0047839318016		81,473
4781	CoCoCo West Pittsburg	5,670,590	30,283	(1,019,546)	4,681,327	.0019742874320		33,623
4782	CoCoCo North Richmond	4,435,169	19,548	(397,672)	4,057,045	.0017110049890		29,139
4783	CoCoCo Pl H/BART Amd 1	1,045,141	8,712	(12,883)	1,040,970	.0004390153055		7,477
4784	Oakley	5,210,807	28,462	(114,802)	5,124,467	.0021611760583		36,806
4785	Rodeo	3,737,902	17,505	(321,309)	3,434,098	.0014482853833		24,665
4786	CoCoCo Montalvin	909,063	3,014	0	912,077	.0003846563610		6,551
								1,984,990
Sub-Total: Recoverable Cost								6,875,075

SCHOOL DISTRICTS - EXEMPT FROM COST ALLOCATION

4016	Ed Phys Handic'd Elem	6,304	1,150	0	7,454	.0000031436637		54
4018	Livemore Jt Unified	301,804	54,705	0	356,509	.0001503527407		2,561
4020	Chabl-Las Positas Com College	346,013	8,315	0	354,328	.0001494330635		2,545
4022	Dev Ctr Handic'd Minor	1,129	206	0	1,335	.0000005631620		10
4029	Trainable M.R. Alameda	2,844	519	0	3,363	.0000014183935		24
5001	Acalanes Union Hi Gen	53,640,663	517,826	0	54,158,489	.0228406252077		388,987
5101	Canyon Elementary Gen	86,181	1,282	0	87,463	.0000368865006		628
5201	Lafayette Elementary Gen	20,286,787	181,179	0	20,467,966	.00863209355872		147,009
5301	Moraga Elementary Gen	9,990,579	95,647	0	10,086,226	.0042537321901		72,443
5401	Orinda Elementary Gen	13,053,323	144,507	0	13,197,830	.0055660097866		94,792
5501	Walnut Creek General	26,307,845	253,698	0	26,561,543	.0112019788637		190,775
6001	Liberty Union Hi Gen	34,978,770	298,334	0	35,277,104	.0148776510436		253,374

**CONTRA COSTA COUNTY
2021-2022 ADMINISTRATIVE COST ALLOCATION**

Fund No	Jurisdiction	Adjusted	2021-2022	2021-2022	Net	2021-2022	Allocate
		2021-2022 AB 8 Allocation	Unitary Allocation	Pass-thru H&S 33676	Revenue	Adj Allocation Factors	
		(1)	(2)	(3)	(4)	(5)	(6)
6101	Brentwood Elem Gen	19,087,226	143,094	11,862	19,242,182	.0081151351432	138,205
6201	Byron Elementary Gen	5,356,159	57,941	6,950	5,421,050	.0022862558024	38,936
6301	Knightsen Elementary Gen	2,381,396	25,043	4,958	2,411,397	.0010169745503	17,320
6401	Oakley Elementary Gen	14,844,080	125,607	0	14,969,687	.0063132671694	107,518
6901	County Schools Gen	35,170,568	520,471	93,075	35,784,114	.0150914759539	257,015
6999	ERAF K - 12	281,547,716	0	0	281,547,716	.1187390190718	2,022,183
7101	Antioch Unified Gen	37,649,411	884,494	81,793	38,615,698	.0162856591585	277,353
7201	John Swett General	6,511,715	159,257	144,908	6,815,880	.0028745071656	48,954
7401	Martinez Unified Gen	19,783,247	294,170	0	20,077,417	.0084673845142	144,204
7501	Mt Diablo Unified Gen	132,223,306	1,680,913	415,311	134,319,530	.0566474820117	964,734
7601	Pittsburg Unified Gen	5,790,032	1,183,760	19,015	6,992,807	.0029491237457	50,225
7701	West Co Co Unified Gen	78,088,870	1,051,073	165,545	79,305,488	.0334460388092	569,602
7801	San Ramon Valley Unif	179,572,557	2,171,639	899,876	182,644,072	.0770277174048	1,311,819
7901	Co Co Comm College Gen	101,920,888	1,481,308	332,412	103,734,608	.0437486964664	745,061
7999	ERAF Community College	41,918,829	0	0	41,918,829	.0176787107761	301,077
TOTALS		\$ 2,340,499,136	30,648,263	(0)	\$ 2,371,147,399	1.0000000000000	\$ 17,030,484
Sub-Total: Exempt School Share							8,147,408



Contra
Costa
County

To: Board of Supervisors
From: Mary Ann Mason, County Counsel
Date: March 8, 2022

Subject: Continuing Teleconference Meetings (AB 361, Government Code § 54953(e))

RECOMMENDATION(S):

1. FIND that the Board of Supervisors has reconsidered the circumstances of the Statewide state of emergency proclaimed by the Governor on March 4, 2020, and the Countywide local emergency proclaimed by the Board of Supervisors on March 10, 2020.
2. FIND that the following circumstances exist: (a) the Statewide state of emergency and the Countywide local emergency continue to directly impact the ability of the Board of Supervisors in all its capacities, its committees, and its advisory bodies to meet safely in person because the highly transmissible Omicron variant of COVID 19 is present and is the predominate strain in the County, and while local COVID 19 test positivity and hospitalizations are decreasing they are still high; and (b) the County Health Officer's recommendations for safely holding public meetings, which recommend virtual meetings and other measures to promote social distancing, are still in effect.
3. AUTHORIZE the Board of Supervisors, in its capacity as the governing board of the County, the Contra Costa County Fire Protection District, the Housing Authority of the County of Contra Costa, the Contra Costa County Flood Control and Water Conservation District, and the Contra Costa County In-Home Supportive Services Public Authority, and its subcommittees, to continue teleconference meetings under Government Code section 54953(e) for the next 30 days.
4. AUTHORIZE and DIRECT all advisory bodies, committees, and commissions established by the Board in all its capacities, including but not limited to municipal advisory councils and the Measure X Community Advisory Body, to continue teleconference meetings under Government Code section 54953(e) for the next 30 days.
5. DIRECT the Planning Commission, Merit Board, and Assessment Appeals Board to consider holding teleconference meetings under Government Code section 54953(e) for the next 30 days.

APPROVE

OTHER

RECOMMENDATION OF CNTY ADMINISTRATOR

RECOMMENDATION OF BOARD COMMITTEE

Action of Board On: **03/08/2022** APPROVED AS RECOMMENDED OTHER

Clerks Notes:

VOTE OF SUPERVISORS

I hereby certify that this is a true and correct copy of an action taken and entered on the minutes of the Board of Supervisors on the date shown.

ATTESTED: March 8, 2022

Monica Nino, County Administrator and Clerk of the Board of Supervisors

Contact: Mary Ann McNett Mason, County Counsel, (925) 655-2200

By: , Deputy

cc: Mary Ann McNett Mason, County Counsel, Monica Nino, Clerk of the Board of Supervisors

RECOMMENDATION(S): (CONT'D)

6. DIRECT the County Administrator/Clerk of the Board and staff to the various Board advisory bodies to take all actions necessary to implement the intent and purpose of this Board order, including conducting open and public meetings in accordance with Government Code section 54953(e) and all other applicable provisions of the Brown Act.

7. DIRECT the County Administrator/Clerk of the Board to return to the Board acting in all its capacities, no later than 30 days after this Board order is adopted, with an item to reconsider the state of emergency and whether to continue meeting virtually under the provisions of Government Code section 54953(e) and to make required findings as to all bodies covered by this Board order.

FISCAL IMPACT:

This is an administrative action with no direct fiscal impact.

BACKGROUND:

On October 5, 2021, the Board adopted Resolution No. 2021/327, which authorized the Board, in all its capacities, and certain subcommittees and advisory bodies, to conduct teleconferencing meetings under Government Code section 54953(e). This section of the Brown Act, which was added by Assembly Bill 361, allows a local agency to use special teleconferencing rules during a State declared state of emergency. When a legislative body uses the emergency teleconferencing provisions under Government code section 54953(e), the following rules apply:

- The agency must provide notice of the meeting and post an agenda as required by the Brown Act and Better Government Ordinance, but the agenda does not need to list each teleconference location or be physically posted at each teleconference location.
- The agenda must state how members of the public can access the meeting and provide public comment.
- The agenda must include an option for all persons to attend via a call-in or internet-based service option.
- The body must conduct the meeting in a manner that protects the constitutional and statutory rights of the public.
- If there is a disruption in the public broadcast of the meeting, or of the public's ability to comment virtually for reasons within the body's control, the legislative body must stop the meeting and take no further action on agenda items until public access and/or ability to comment is restored.
- Local agencies may not require public comments to be submitted in advance of the meeting and must allow virtual comments to be submitted in real time.
- The body must allow a reasonable amount of time per agenda item to permit members of the public to comment, including time to register or otherwise be recognized for the purposes of comment.
- If the body provides a timed period for all public comment on an item, it may not close that period before the time has elapsed.
- AB 361 sunsets on January 1, 2024.

Under Government Code section 54953(e), if the local agency wishes to continue using these special teleconferencing rules after adopting an initial resolution, the legislative body must reconsider the circumstances of the state of emergency every 30 days and make certain findings. The agency must find that the state declared emergency continues to exist and either that it continues to directly impact the ability of officials and members of the public to meet safely in person, or that state or local officials continue to impose or recommend measures to promote social distancing.

The Board last considered these matters on February 8, 2022, made the required findings and continued use of special teleconferencing rules. The Board can again find that the Statewide state of emergency continues to exist, that the state and Countywide local emergencies continue to directly impact the ability of the Board of Supervisors in all its capacities, and its subcommittees, and advisory bodies to meet safely in person, and that state or local officials continue to impose or recommend measures to promote social distancing.

The Public Health Officer has advised that the highly transmissible Omicron variant of COVID 19 is present and is the predominate strain in the County, and COVID 19 test positivity and hospitalizations remain at a high level. In addition, on March 1, 2022, the County Health Officer again issued recommendations for safely holding public meetings that included recommended measures to promote social distancing. (See Attachment A, Health Officer's Recommendations). Among the Health Officer's recommendations: (1) on-line meetings (teleconferencing meetings) are strongly recommended as those meetings present the lowest risk of transmission of SARS-CoV-2, the virus that causes COVID-19; (2) if a local agency determines to hold in-person meetings, offering the public the opportunity to attend via a call-in option or an internet-based service option is recommended when possible to give those at higher risk of and/or higher concern about COVID-19 an alternative to participating in person; (3) a written safety protocol should be developed and followed, and it is recommended that the protocol require social distancing - i.e., six feet of separation between attendees - and face masking of all attendees; (4) seating arrangements should allow for staff and members of the public to easily maintain at least six-foot distance from one another at all practicable times. These recommendations are still in effect.

CONSEQUENCE OF NEGATIVE ACTION:

The Board, in all its capacities, and its subcommittees and advisory bodies, would no longer conduct teleconferencing meetings under Government Code section 54953(e).

CLERK'S ADDENDUM

Speakers: No name given; Liz Ritchie.

ADOPTED the recommendations with amended language to change DIRECT in items number 4 and 5 to be AUTHORIZE.

The Board of Supervisors will be meeting in-person its chambers on March 29, 2022 and meetings thereafter. All advisory bodies, committees, and commissions established by the Board in all its capacities, members of staff, and participants in the meeting are welcome to continue participating in the meeting via remote is they so desire.

Masking is not required.

ATTACHMENTS

PHO Recommendations 3-1-22



Recommendations for safely holding public meetings

Each local government agency is authorized to determine whether to hold public meetings in person, on-line (teleconferencing only), or via a combination of methods. The following are recommendations from the Contra Costa County Health Officer to minimize the risk of COVID 19 transmission during a public meeting.

1. Online meetings (i.e. teleconferencing meetings) are strongly recommended as these meetings present the lowest risk of transmission of SARS CoV -2, the virus that causes COVID 19. This is particularly important in light of the current community prevalence rate as of March 1, 2022. Our current trends as of March 1, 2022 in Covid-19 case rate, Covid-19 test positivity, and Covid-19 hospitalizations are decreasing, but cases rates remain high with the Omicron variant of Covid-19 being the predominant variant identified, the impact of which on the spread of Covid-19 has shown to dramatically increase COVID-19 transmission.
2. If a local agency determines to hold in-person meetings, offering the public the opportunity to attend via a call-in option or an internet-based service option is recommended, when possible, to give those at higher risk of and/or higher concern about COVID-19 an alternative to participating in person.
3. A written safety protocol should be developed and followed. It is recommended that the protocol require social distancing –i.e., six feet of separation between attendees –and face masking of all attendees.
4. Seating arrangements should allow for staff and members of the public to easily maintain at least six-foot distance from one another at all practicable times.
5. Consider holding public meetings outdoors. Increasing scientific consensus is that outdoor airflow reduces the risk of COVID-19 transmission compared to indoor spaces. Hosting events outdoors also may make it easier to space staff and members of the public at least 6 feet apart.
6. Current evidence is unclear as to the added benefit of temperature checks in addition to symptom checks. We encourage focus on symptom checks as they may screen out individuals with other Covid-19 symptoms besides fever and help reinforce the message to not go out in public if you are not feeling well.
7. Consider a voluntary attendance sheet with names and contact information to assist in contact tracing of any cases linked to a public meeting.

Revised 3-1-2022

Sefanit Mekuria

Sefanit Mekuria, MD, MPH
Deputy Health Officer, Contra Costa County





Contra
Costa
County

To: Board of Supervisors
From: Brian M. Balbas, Public Works Director/Chief Engineer
Date: March 8, 2022

Subject: Assignment and Assumption Agreement and Amendment with Dewberry Engineers Inc. d/b/a Dewberry | Drake Haglan, Countywide.

RECOMMENDATION(S):

APPROVE and AUTHORIZE the Public Works Director, or designee, to execute an Amendment with Dewberry Engineers Inc. d/b/a Dewberry | Drake Haglan, acknowledging the Assignment and Assumption Agreement between Drake, Haglan & Associates, Inc. and Dewberry Engineers Inc. d/b/a Dewberry | Drake Haglan, effective September 28, 2019, and adjusting the per phase Payment Limits and Fixed Fee amount to incorporate the cost of optional tasks approved by the County to be performed by the Consultant for professional engineering services for the Byron Highway Bridge Replacement Project, with no change to the overall payment limit of \$1,403,456 or term of September 11, 2018 through June 30, 2025, Byron area. County Project No.: 4660-6X1048, Federal Project No.: BRLS 5928(104) (District III).

FISCAL IMPACT:

There is no fiscal impact as there is no increase to the overall contract payment limit. Work performed under the Byron Highway Bridge Replacement Project contract is funded by 88.5% Federal Highway Bridge Program Funds, 8.5% Department of Water Resources Funds and 3% Local Road Funds.

APPROVE

OTHER

RECOMMENDATION OF CNTY ADMINISTRATOR

RECOMMENDATION OF BOARD COMMITTEE

Action of Board On: **03/08/2022** APPROVED AS RECOMMENDED OTHER

Clerks Notes:

VOTE OF SUPERVISORS

AYE: John Gioia, District I Supervisor
Candace Andersen, District II Supervisor
Diane Burgis, District III Supervisor
Karen Mitchoff, District IV Supervisor
Federal D. Glover, District V Supervisor

I hereby certify that this is a true and correct copy of an action taken and entered on the minutes of the Board of Supervisors on the date shown.

ATTESTED: March 8, 2022

Monica Nino, County Administrator and Clerk of the Board of Supervisors

By: Stacey M. Boyd, Deputy

Contact: Neil Leary (925) 313-2278

cc:

BACKGROUND:

This project will replace the Byron Highway Bridge (#28C-0121), which spans the California Aqueduct and is located approximately 11 miles northwest of Tracy and 4 miles southeast of Byron.

On September 11, 2018, County contracted with Drake, Haglan & Associates, Inc. to provide professional engineering services for the Project after completing a request for proposal solicitation and technical proposal process. Professional engineering services for the Project include full and complete design engineering and structural design services as well as providing geotechnical and hydraulic studies, construction support, project management and coordination, and environmental clearance and permitting services, and right of way support, for the proper and satisfactory execution of the Byron Highway Bridge Replacement project.

On September 28, 2019, Dewberry Engineers Inc. d/b/a Dewberry | Drake Haglan was assigned the Project's agreement from Drake, Haglan & Associates, Inc. through an Assignment and Assumption Agreement. This amendment provides for the acknowledgement of the assignment of the County agreement from Drake, Haglan & Associates, Inc. to Dewberry Engineers Inc. d/b/a Dewberry | Drake Haglan, which is necessary for the continuation of design and construction support through the remaining phases of the contract. The amendment also increases the fixed fee to \$109,166.68 and adjusts the Per Phase Payment Limits within the original overall Payment Limit for performance of optional tasks included in the scope of services, which is necessary for the continuation of design and construction support through the remaining phases of the contract. The optional tasks performed require more Dewberry Engineers Inc. d/b/a Dewberry | Drake Haglan labor and less direct costs than initially assumed in the fee table, resulting in a necessary increase to the Fixed Fee.

Government Code Section 31000 authorizes the County to contract for services including the Project services that Dewberry Engineers Inc. d/b/a Dewberry | Drake Haglan provides.

CONSEQUENCE OF NEGATIVE ACTION:

Without approval from the Board of Supervisors, a delay in construction of the Project will occur, which will ultimately delay the completion of the Project, result in substantial additional project costs and jeopardize the funding.



Contra
Costa
County

To: Board of Supervisors
From: Brian M. Balbas, Public Works Director/Chief Engineer
Date: March 8, 2022

Subject: Approve the Final Map for subdivision SD21-09582 (cross-reference DP20-03007), Bethel Island area.

RECOMMENDATION(S):

ADOPT Resolution No. 2022/63 approving the Final Map for subdivision SD21-09582 (cross-reference DP20-03007), for a project being developed by SDC Delta Coves, LLC, as recommended by the Public Works Director, Bethel Island area. (District III)

FISCAL IMPACT:

No fiscal impact.

BACKGROUND:

The developer, SDC Delta Coves, LLC, has requested the County terminate interests in Delta Coves Drive, Shoreline Place, Slough Place, Sea Drift Drive, Sea Meadow Court, Point Place, Channel Place, Isle Place, Halcyon Place, Sandy Lane, Navigator's Place, Waterside Place, Edgewater Drive, Edgewater Court, Sea Gate Place, Seaward Court, Grey Whale Place, and West Wind Place as previously offered for public purposes on the Final Map of subdivision SD80-06013 (476 M 37). The developer received approval for a development plan permit DP20-03007 for the privatization of said roads. The County has not accepted said roads for completion of improvements or declared them as County roads. It was determined that the appropriate mechanism to terminate the County interests in the previous offers of dedication for public purposes would necessitate approval of a Final Map over the affected streets. The Public Works Department has reviewed the conditions of approval for development plan permit DP20-03007 and has determined that all conditions of approval have been satisfied.

CONSEQUENCE OF NEGATIVE ACTION:

The Map will not be approved and the County's interest in the affected streets will not be terminated.

APPROVE

OTHER

RECOMMENDATION OF CNTY ADMINISTRATOR

RECOMMENDATION OF BOARD COMMITTEE

Action of Board On: **03/08/2022** APPROVED AS RECOMMENDED OTHER

Clerks Notes:

VOTE OF SUPERVISORS

AYE: John Gioia, District I Supervisor
Candace Andersen, District II Supervisor
Diane Burgis, District III Supervisor
Karen Mitchoff, District IV Supervisor
Federal D. Glover, District V Supervisor

I hereby certify that this is a true and correct copy of an action taken and entered on the minutes of the Board of Supervisors on the date shown.

ATTESTED: March 8, 2022

Monica Nino, County Administrator and Clerk of the Board of Supervisors

By: Stacey M. Boyd, Deputy

Contact: Randolph Sanders (925) 313-2111

AGENDA ATTACHMENTS

Resolution No. 2022/63

Subdivision Final Map

Tax Letter

MINUTES ATTACHMENTS

Signed: Resolution No.

2022/63

THE BOARD OF SUPERVISORS OF CONTRA COSTA COUNTY, CALIFORNIA
and for Special Districts, Agencies and Authorities Governed by the Board

Adopted this Resolution on 03/08/2022 by the following vote:

		John Gioia
		Candace Andersen
AYE:	<input type="text" value="5"/>	Diane Burgis
		Karen Mitchoff
		Federal D. Glover
NO:	<input type="text"/>	
ABSENT:	<input type="text"/>	
ABSTAIN:	<input type="text"/>	
RECUSE:	<input type="text"/>	



Resolution No. 2022/63

IN THE MATTER OF approving the Final Map for subdivision SD21-09582 (cross-reference DP20-03007), for a project being developed by SDC Delta Coves, LLC, as recommended by the Public Works Director, Bethel Island area. (District III)

WHEREAS, the following documents were presented for board approval this date:

The Final Map of subdivision SD21-09582 (cross-reference DP20-03007), property located in the Bethel Island area, Supervisorial District III, said map having been certified by the proper officials.

Said document was accompanied by:

1. Letter from the County Tax Collector stating that there are no unpaid County taxes heretofore levied on the property included in said map and that the 2021-2022 tax lien has been paid in full and the 2022-2023 tax lien, which became a lien on the first day of January 2022, is estimated to be \$0.00.

NOW, THEREFORE, BE IT RESOLVED:

1. That said subdivision, together with the provisions for its design and improvement, is DETERMINED to be consistent with the County's general and specific plans.
2. That said Final map is APPROVED and this Board does hereby *accept subject to installation and acceptance of improvements* on behalf of the public any of the streets, paths, or easements shown thereon as dedicated to public use.

I hereby certify that this is a true and correct copy of an action taken and entered on the minutes of the Board of Supervisors on the date shown.

ATTESTED: March 8, 2022

Monica Nino, County Administrator and Clerk of the Board of Supervisors

Contact: Randolf Sanders (925) 313-2111

By: Stacey M. Boyd, Deputy

cc: Larry Gossett- Engineering Services, Randolf Sanders- Engineering Services, Joshua Laranang- Engineering Services, Ruben Hernandez - DCD, SDC Delta Coves, LLC, First American Title Company, T-01/08/2023

**SUBDIVISION 9582
DELTA COVES STREETS**

LANDS DESIGNATED AS SANDY LANE, DELTA COVES DRIVE, STONE ROAD, SHORELINE PLACE, SLOUGH PLACE, SEA DRIFT DRIVE, SEA MEADOW COURT, POINT PLACE, CHANNEL PLACE, ISLE PLACE, HALCYON PLACE, NAVIGATOR'S PLACE, WATERSIDE PLACE, GATEWAY ROAD, EDGEWATER DRIVE, EDGEWATER COURT, SEA GATE PLACE, SEAWARD COURT, GREY WHALE PLACE, WINDSWEEP ROAD, AND WEST WIND PLACE AS DESIGNATED ON SUBDIVISION 6013 (476 M 37), CONTRA COSTA COUNTY RECORDS

CONTRA COSTA COUNTY
CALIFORNIA

RUGGERI-JENSEN-AZAR
CIVIL ENGINEERS, PLANNERS, SURVEYORS
PLEASANTON, CALIFORNIA
SEPTEMBER 2021

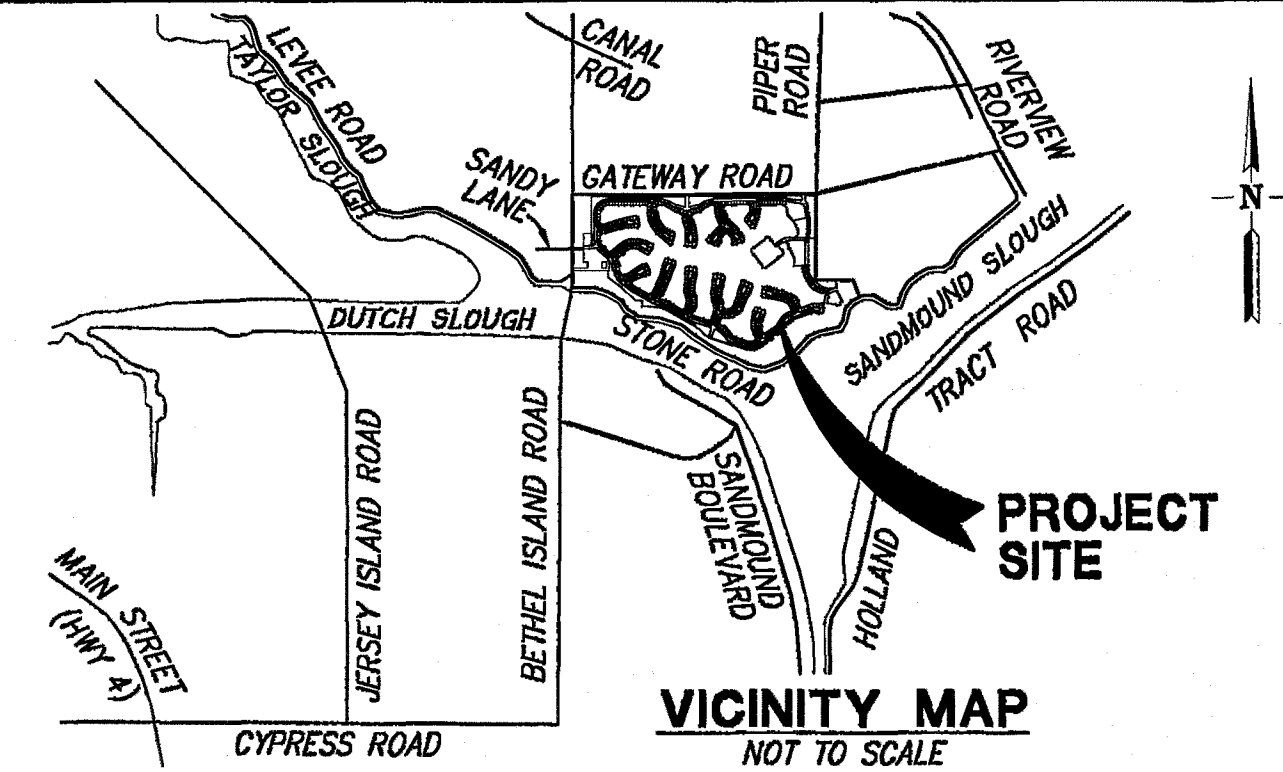

OWNER'S STATEMENT

THE UNDERSIGNED, BEING THE PARTIES HAVING A RECORD TITLE INTEREST IN THE LANDS DELINEATED AND EMBRACED WITHIN THE MAP BOUNDARY ON THIS MAP, ENTITLED "SUBDIVISION 9582, DELTA COVES STREETS", CONTRA COSTA COUNTY, CALIFORNIA, DO HEREBY CONSENT TO THE MAKING AND RECORDATION OF THE SAME.

THE REAL PROPERTY DESCRIBED AS FOLLOWS IS DEDICATED IN FEE FOR PUBLIC STREET PURPOSES: THOSE PORTIONS OF SAID LANDS DESIGNATED AS GATEWAY ROAD, BETHEL ISLAND ROAD, WINDSWEEP ROAD, AND STONE ROAD.

THE REAL PROPERTY DESCRIBED BELOW IS DEDICATED AS AN EASEMENT FOR PUBLIC PURPOSES: THE AREAS DESIGNATED AS "PUBLIC UTILITY EASEMENT" OR "PUE" ARE FOR PUBLIC UTILITY PURPOSES INCLUDING POLES, WIRES, CONDUITS, STORM DRAINS, FLOOD AND SURFACE WATER DRAINAGE, WATER LINES, GAS LINES, ELECTRIC, TELEPHONE AND CABLE TELEVISION UTILITIES, INCLUDING THE RIGHTS OF INGRESS, EGRESS, CONSTRUCTION, RECONSTRUCTION, ACCESS FOR MAINTENANCE OF WORKS, IMPROVEMENTS AND STRUCTURES, AND THE CLEARING OF OBSTRUCTIONS AND VEGETATION.

THE REAL PROPERTY DESCRIBED BELOW IS DEDICATED TO THE BETHEL ISLAND MUNICIPAL IMPROVEMENT DISTRICT (BIMID) AS AN EASEMENT FOR PUBLIC PURPOSES: THE AREAS DESIGNATED AS "PUBLIC LEVEE MAINTENANCE EASEMENT" OR "LVME" ARE FOR THE PURPOSE OF CONSTRUCTING, RECONSTRUCTING, MAINTAINING OR REPAIRING LEVEES.

THE REAL PROPERTY DESIGNATED AS PARCEL A (DELTA COVES DRIVE, SHORELINE PLACE, SLOUGH PLACE, SEA DRIFT DRIVE, SEA MEADOW COURT, POINT PLACE, CHANNEL PLACE, ISLE PLACE, HALCYON PLACE), PARCEL B (SANDY LANE, DELTA COVES DRIVE, NAVIGATOR'S PLACE, WATERSIDE PLACE, EDGEWATER DRIVE, EDGEWATER COURT, SEA GATE PLACE, SEAWARD COURT, GREY WHALE PLACE), AND PARCEL C (WEST WIND PLACE) ARE FOR PRIVATE STREET PURPOSES. THE PUBLIC DEDICATION OVER THESE PARCELS OFFERED ON THE MAP OF SUBDIVISION 6013 (476 M 37) IS HEREBY TERMINATED (GOVERNMENT CODE SECTION 66499.20.2).

THE MAP SHOWS ALL EASEMENTS ON THE PREMISES, OR OF RECORD.

OWNER: SDC DELTA COVES, LLC, A DELAWARE LIMITED LIABILITY COMPANY

DATE: 10-1-21 BY: Nick Taratsas
NICK TARATSAS, ITS AUTHORIZED AGENT

OWNER'S ACKNOWLEDGEMENT

A NOTARY PUBLIC OR OTHER OFFICER COMPLETING THIS CERTIFICATE VERIFIES ONLY THE IDENTITY OF THE INDIVIDUAL WHO SIGNED THE DOCUMENT TO WHICH THIS CERTIFICATE IS ATTACHED, AND NOT THE TRUTHFULNESS, ACCURACY, OR VALIDITY OF THAT DOCUMENT.

STATE OF ~~CALIFORNIA~~ Arizona)
COUNTY OF Maricopa)

ON October 1, 2021, BEFORE ME, Mary E. Wesnoski
A NOTARY PUBLIC IN AND FOR SAID COUNTY AND STATE, PERSONALLY APPEARED Nick Taratsas
WHO PROVED TO ME ON THE BASIS OF SATISFACTORY EVIDENCE TO BE THE PERSON(S) WHOSE NAME(S) IS/ARE SUBSCRIBED TO THE FOREGOING STATEMENT AND ACKNOWLEDGED TO ME THAT HE/SHE/THEY EXECUTED THE SAME IN HIS/HER/THEIR AUTHORIZED CAPACITY(IES), AND THAT BY THE SIGNATURE(S) ON THE STATEMENT THE PERSON(S) OR THE ENTITY UPON BEHALF OF WHICH THE PERSON(S) ACTED, EXECUTED THE STATEMENT.

I CERTIFY UNDER PENALTY OF PERJURY UNDER THE LAWS OF THE STATE OF CALIFORNIA THAT THE FOREGOING PARAGRAPH IS TRUE AND CORRECT.

WITNESS MY HAND,

SIGNATURE: Mary E. Wesnoski
PRINT NAME: Mary E. Wesnoski
MY COMMISSION NUMBER: 543827
MY COMMISSION EXPIRES: March 16, 2022
PRINCIPAL COUNTY OF BUSINESS: Maricopa

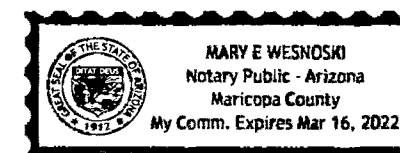

SURVEYOR'S STATEMENT

THIS MAP WAS PREPARED BY ME OR UNDER MY DIRECTION AND IS BASED UPON A FIELD SURVEY IN CONFORMANCE WITH THE REQUIREMENTS OF THE SUBDIVISION MAP ACT AND LOCAL ORDINANCE AT THE REQUEST OF SDC DELTA COVES, LLC, IN OCTOBER 2020, AND IS TRUE AND COMPLETE AS SHOWN. I HEREBY STATE THAT THIS FINAL MAP SUBSTANTIALLY CONFORMS TO THE APPROVED OR CONDITIONALLY APPROVED TENTATIVE MAP, IF ANY. I HEREBY STATE THAT THE MONUMENTS ARE OF THE CHARACTER AND OCCUPY THE POSITIONS AS INDICATED, OR THAT THEY WILL BE SET IN THE POSITIONS INDICATED BEFORE DECEMBER 2022. THE MONUMENTS ARE OR WILL BE SUFFICIENT TO ENABLE THE SURVEY TO BE RETRACED.



Scott A. Shortlidge
SCOTT A. SHORTLIDGE, L.S. NO. 6441 11-5-2021
DATE

CLERK OF THE BOARD OF SUPERVISORS CERTIFICATE

STATE OF CALIFORNIA)
COUNTY OF CONTRA COSTA)

I, MONICA NINO, CLERK OF THE BOARD OF SUPERVISORS AND COUNTY ADMINISTRATOR OF THE COUNTY OF CONTRA COSTA, STATE OF CALIFORNIA, DO HEREBY CERTIFY THAT THE ABOVE AND FOREGOING MAP ENTITLED "SUBDIVISION 9582, DELTA COVES STREETS", CONTRA COSTA COUNTY, CALIFORNIA, WAS PRESENTED TO SAID BOARD OF SUPERVISORS, AS PROVIDED BY LAW, AT A REGULAR MEETING THEREOF HELD ON THE _____ DAY OF _____, 20____, AND THAT SAID BOARD OF SUPERVISORS DID THEREUPON BY RESOLUTION DULY PASSED AND ADOPTED AT SAID MEETING, APPROVE SAID MAP AND DID ACCEPT SUBJECT TO INSTALLATION AND ACCEPTANCE OF IMPROVEMENTS ON BEHALF OF THE PUBLIC GATEWAY ROAD, BETHEL ISLAND ROAD, WINDSWEEP ROAD, AND STONE ROAD SHOWN THEREON AS DEDICATED TO PUBLIC USE. THE PUBLIC DEDICATION OVER THE PRIVATE STREETS (PARCELS A, B, AND C) AS OFFERED ON THE MAP OF SUBDIVISION 6013 (476 M 37) IS HEREBY TERMINATED.

I FURTHER STATE THAT ALL TAX LIENS HAVE BEEN SATISFIED AND THAT ALL BONDS AS REQUIRED BY LAW TO ACCOMPANY THE WITHIN MAP HAVE BEEN APPROVED BY THE BOARD OF SUPERVISORS OF CONTRA COSTA COUNTY, AND FILED IN MY OFFICE.

IN WITNESS WHEREOF, I HAVE HEREUNTO SET MY HAND THIS _____ DAY OF _____, 20____.

MONICA NINO
CLERK OF THE BOARD OF SUPERVISORS
AND COUNTY ADMINISTRATOR

BY: _____
DEPUTY CLERK

COUNTY SURVEYOR'S STATEMENT

THIS MAP WAS EXAMINED BY ME AND IS SUBSTANTIALLY THE SAME AS IT APPEARED ON THE TENTATIVE MAP, AND ANY APPROVED ALTERATIONS THEREOF. ALL PROVISIONS OF THE SUBDIVISION MAP ACT AND OF ANY LOCAL ORDINANCES APPLICABLE AT THE TIME OF APPROVAL OF THE TENTATIVE MAP HAVE BEEN COMPLIED WITH. I AM SATISFIED THAT THE MAP IS TECHNICALLY CORRECT.

JAMES A. STEIN, P.L.S. 6571 DATE
COUNTY SURVEYOR

RECORDER'S STATEMENT

FILED THIS _____ DAY OF _____, 20____, AT _____ M.
IN BOOK _____ OF MAPS AT PAGES _____, AT THE REQUEST OF _____
TITLE COMPANY.

DOCUMENT NO. _____ DEBORAH COOPER
COUNTY RECORDER

BY: _____
DEPUTY COUNTY RECORDER

SIGNATURES OMITTED

IN ACCORDANCE WITH SECTION 66445(e) OF THE SUBDIVISION MAP ACT, SIGNATURES OF PARTIES OWNING THE FOLLOWING INTERESTS, WHICH CANNOT RIPEN INTO A FEE, HAVE BEEN OMITTED:

- 1) 2018-0184230 - PACIFIC GAS & ELECTRIC
- 2) 2020-0027913 - IRONHOUSE SANITARY DISTRICT

**SUBDIVISION 9582
DELTA COVES STREETS**

LANDS DESIGNATED AS SANDY LANE, DELTA COVES DRIVE, STONE ROAD, SHORELINE PLACE, SLOUGH PLACE, SEA DRIFT DRIVE, SEA MEADOW COURT, POINT PLACE, CHANNEL PLACE, ISLE PLACE, HALCYON PLACE, NAVIGATOR'S PLACE, WATERSIDE PLACE, GATEWAY ROAD, EDGEWATER DRIVE, EDGEWATER COURT, SEA GATE PLACE, SEAWARD COURT, GREY WHALE PLACE, WINDSWEEP ROAD, AND WEST WIND PLACE AS DESIGNATED ON SUBDIVISION 6013 (476 M 37), CONTRA COSTA COUNTY RECORDS

CONTRA COSTA COUNTY
CALIFORNIA
RUGGERI-JENSEN-AZAR
CIVIL ENGINEERS, PLANNERS, SURVEYORS
PLEASANTON, CALIFORNIA
SEPTEMBER 2021

61400001101001 SURVEY CAD FILES (PKL MAP) 11/05/2021 12:28:14 PM ALAN MULLER

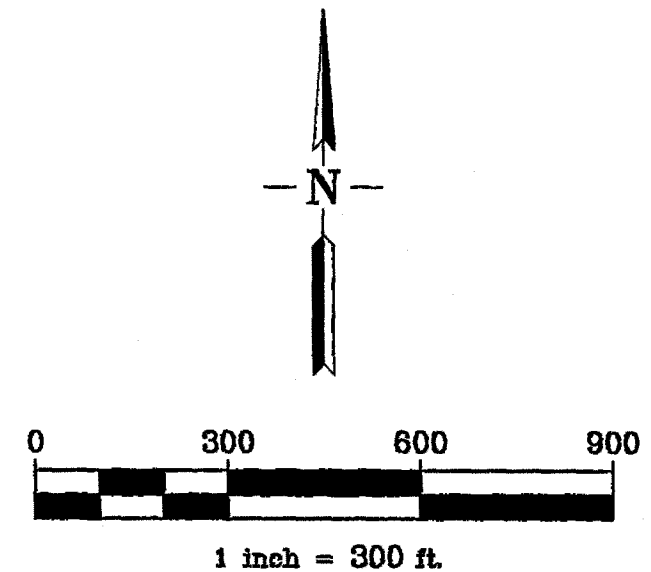
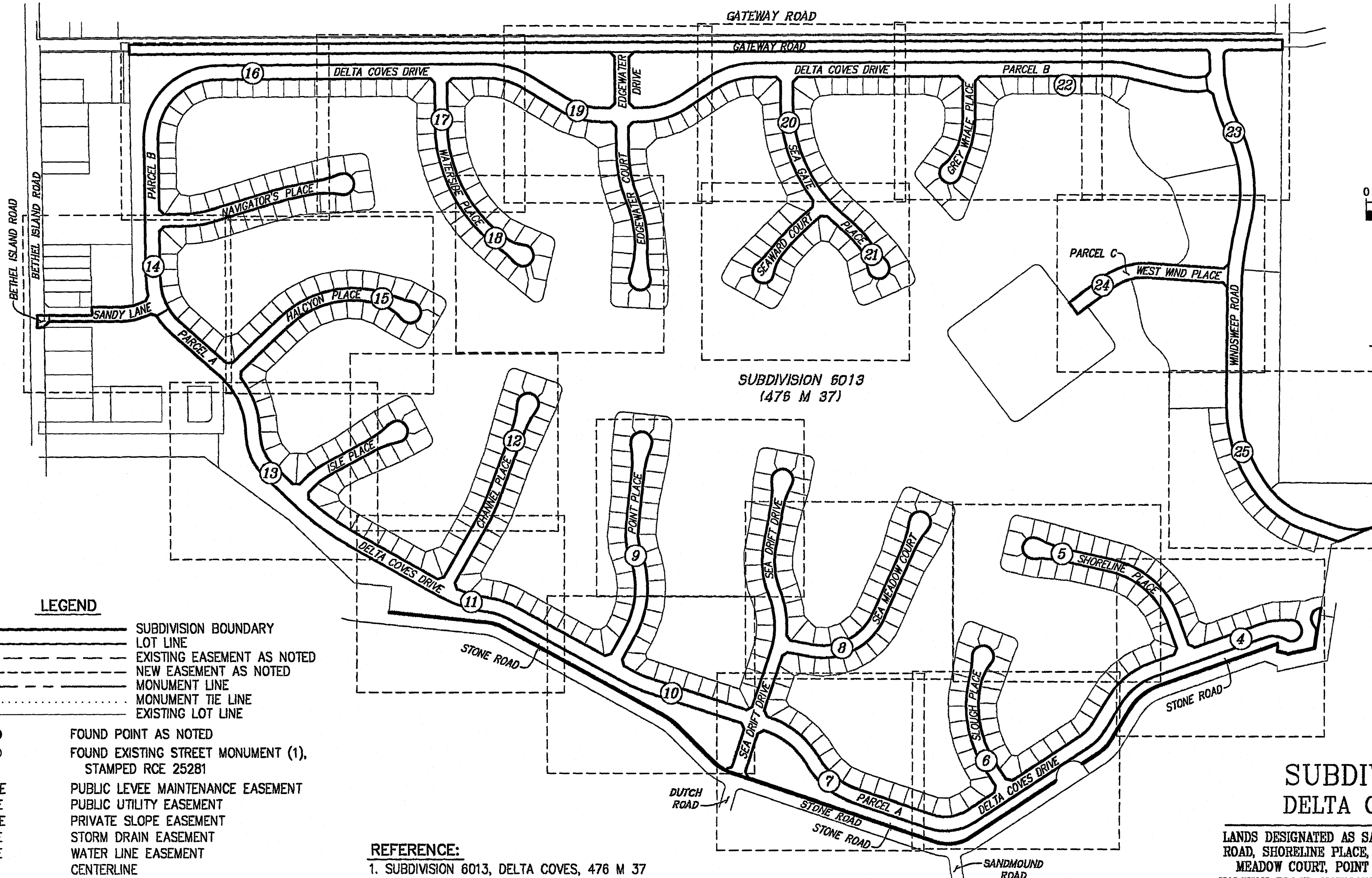

**SUBDIVISION
INDEX MAP**

SUBDIVISION 6013
(476 M 37)

**SUBDIVISION 9582
DELTA COVES STREETS**

LANDS DESIGNATED AS SANDY LANE, DELTA COVES DRIVE, STONE ROAD, SHORELINE PLACE, SLOUGH PLACE, SEA DRIFT DRIVE, SEA MEADOW COURT, POINT PLACE, CHANNEL PLACE, ISLE PLACE, HALCYON PLACE, NAVIGATOR'S PLACE, WATERSIDE PLACE, GATEWAY ROAD, EDGEWATER DRIVE, EDGEWATER COURT, SEA GATE PLACE, SEAWARD COURT, GREY WHALE PLACE, WINDSWEEP ROAD, AND WEST WIND PLACE AS DESIGNATED ON SUBDIVISION 6013 (476 M 370), CONTRA COSTA COUNTY RECORDS

CONTRA COSTA COUNTY
CALIFORNIA
RUGGERI-JENSEN-AZAR
CIVIL ENGINEERS, PLANNERS, SURVEYORS
PLEASANTON, CALIFORNIA
SEPTEMBER 2021
SCALE: 1"=300'

LEGEND

- SUBDIVISION BOUNDARY
- LOT LINE
- - - EXISTING EASEMENT AS NOTED
- - - NEW EASEMENT AS NOTED
- MONUMENT LINE
- - - MONUMENT TIE LINE
- - - EXISTING LOT LINE

- FOUND POINT AS NOTED
- ⊙ FOUND EXISTING STREET MONUMENT (1), STAMPED RCE 25281
- LVME PUBLIC LEVEE MAINTENANCE EASEMENT
- PUE PUBLIC UTILITY EASEMENT
- PSLE PRIVATE SLOPE EASEMENT
- SDE STORM DRAIN EASEMENT
- WLE WATER LINE EASEMENT
- ⊕ CENTERLINE
- EX. EXISTING
- (M-M) MONUMENT TO MONUMENT
- (R) RADIAL BEARING
- (T) TOTAL
- FND FOUND
- IP IRON PIPE
- R/W RIGHT OF WAY
- STD STANDARD
- CCC COUNTY OF CONTRA COSTA
- (DATA)(1) RECORD DATA & REFERENCE
- SFNF SEARCHED FOR NOTHING FOUND
- NRF NO RECORD FOUND
- ⑦ SHEET NUMBER

REFERENCE:

1. SUBDIVISION 6013, DELTA COVES, 476 M 37

NOTE:

1. ALL MONUMENT TIE LINES ARE AT RIGHT ANGLES TO THE MONUMENT LINE UNLESS OTHERWISE NOTED.

BASIS OF BEARINGS

THE BEARING N89°39'55"E OF THE LINE BETWEEN MONUMENTS AT THE EAST 1/4 CORNER AND THE WEST 1/4 CORNER OF SECTION 15, TOWNSHIP 2 NORTH, RANGE 3 EAST, MOUNT DIABLO BASE AND MERIDIAN, AS SHOWN ON PARCEL MAP MS 124-69 FILED SEPTEMBER 16, 1971 IN BOOK 18 OF PARCEL MAPS AT PAGES 23-24, OFFICIAL RECORDS OF CONTRA COSTA COUNTY.

C:\GEO2021\131019\SURVEY\CAD FILES\TYPICAL MAP\131019-INDEX.DWG 10/14/2021 10:58:35 AM ALAN MULLER

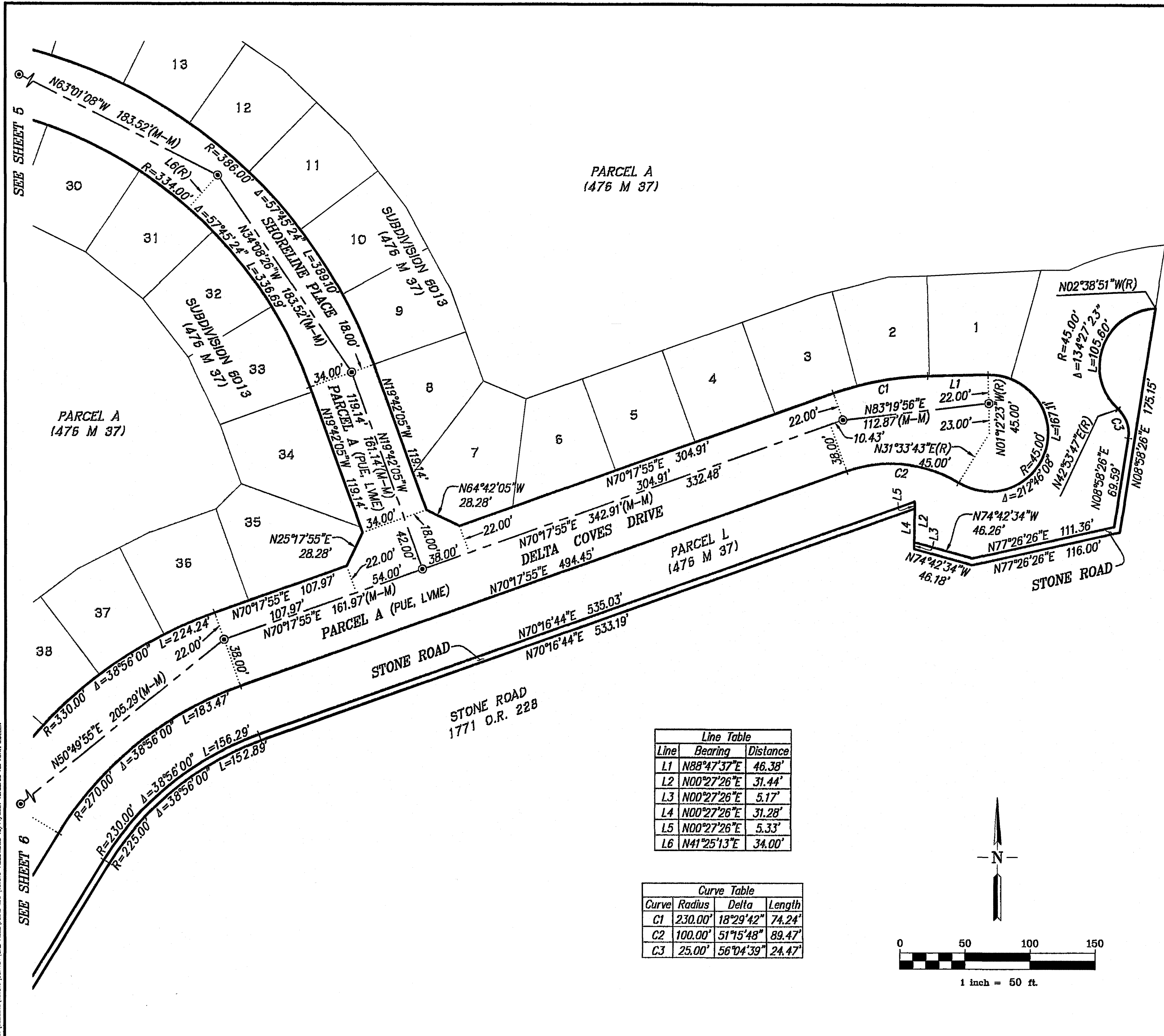

PARCEL A
(476 M 37)

PARCEL A
(476 M 37)

Line	Bearing	Distance
L1	N88°47'37"E	46.38'
L2	N00°27'26"E	31.44'
L3	N00°27'26"E	5.17'
L4	N00°27'26"E	31.28'
L5	N00°27'26"E	5.33'
L6	N41°25'13"E	34.00'

Curve	Radius	Delta	Length
C1	230.00'	18°29'42"	74.24'
C2	100.00'	51°15'48"	89.47'
C3	25.00'	56°04'39"	24.47'

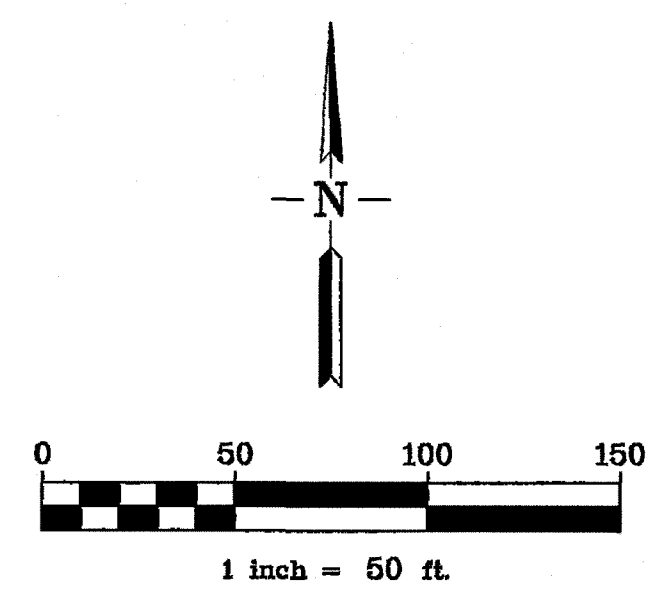

NOTE:

1. ALL MONUMENT TIE LINES ARE AT RIGHT ANGLES TO THE MONUMENT LINE UNLESS OTHERWISE NOTED.

BASIS OF BEARINGS

THE BEARING N89°39'55"E OF THE LINE BETWEEN MONUMENTS AT THE EAST 1/4 CORNER AND THE WEST 1/4 CORNER OF SECTION 15, TOWNSHIP 2 NORTH, RANGE 3 EAST, MOUNT DIABLO BASE AND MERIDIAN, AS SHOWN ON PARCEL MAP MS 124-69 FILED SEPTEMBER 16, 1971 IN BOOK 18 OF PARCEL MAPS AT PAGES 23-24, OFFICIAL RECORDS OF CONTRA COSTA COUNTY.

LEGEND

- SUBDIVISION BOUNDARY
- LOT LINE
- EXISTING EASEMENT AS NOTED
- NEW EASEMENT AS NOTED
- MONUMENT LINE
- MONUMENT TIE LINE
- EXISTING LOT LINE
- FOUND POINT AS NOTED
- FOUND EXISTING STREET MONUMENT (1), STAMPED RCE 25281
- LVME PUBLIC LEVEL MAINTENANCE EASEMENT
- PUE PUBLIC UTILITY EASEMENT
- PSLE PRIVATE SLOPE EASEMENT
- SDE STORM DRAIN EASEMENT
- WLE WATER LINE EASEMENT
- ⊕ CENTERLINE
- EX. EXISTING
- (M-M) MONUMENT TO MONUMENT
- (R) RADIAL BEARING
- (T) TOTAL
- FND FOUND
- IP IRON PIPE
- R/W RIGHT OF WAY
- STD STANDARD
- CCC COUNTY OF CONTRA COSTA
- (DATA)(1) RECORD DATA & REFERENCE
- SFNF SEARCHED FOR NOTHING FOUND
- NRF NO RECORD FOUND

**SUBDIVISION 9582
DELTA COVES STREETS**

LANDS DESIGNATED AS SANDY LANE, DELTA COVES DRIVE, STONE ROAD, SHORELINE PLACE, SLOUGH PLACE, SEA DRIFT DRIVE, SEA MEADOW COURT, POINT PLACE, CHANNEL PLACE, ISLE PLACE, HALCYON PLACE, NAVIGATOR'S PLACE, WATERSIDE PLACE, GATEWAY ROAD, EDGEWATER DRIVE, EDGEWATER COURT, SEA GATE PLACE, SEAWARD COURT, GREY WHALE PLACE, WINDSWEEP ROAD, AND WEST WIND PLACE AS DESIGNATED ON SUBDIVISION 6013 (476 M 370), CONTRA COSTA COUNTY RECORDS

CONTRA COSTA COUNTY
CALIFORNIA

RUGGERI-JENSEN-AZAR
CIVIL ENGINEERS, PLANNERS, SURVEYORS
PLEASANTON, CALIFORNIA
SEPTEMBER 2021
SCALE: 1" = 50'

C:\WORK\131019\131019_FINAL\131019_FINAL.DWG 10/14/2021 10:55:09 AM ALAN MILLER

G:\LAB\2021\131019\SURVEY\CAD FILES\FINAL MAP\131019-REGS.DWG 10/14/2021 10:55:46 AM ALAN MULLEN

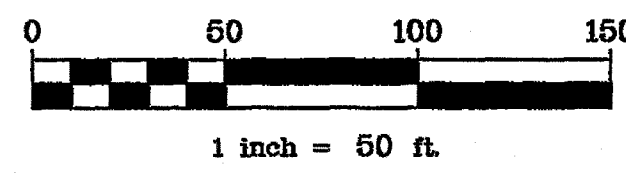
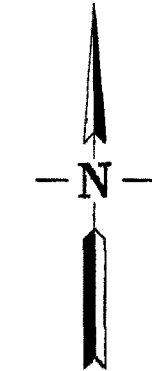
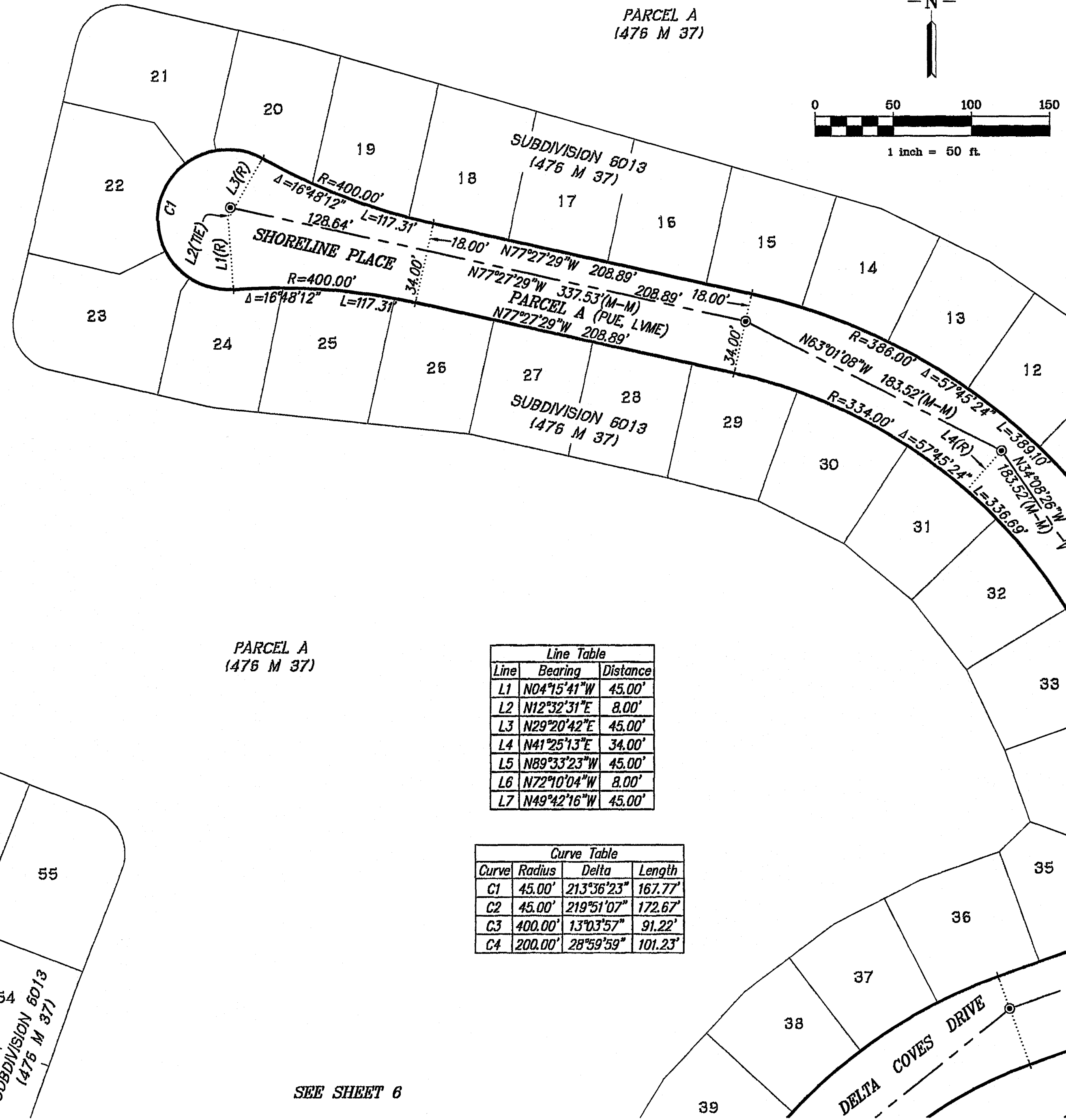

NOTE:

1. ALL MONUMENT TIE LINES ARE AT RIGHT ANGLES TO THE MONUMENT LINE UNLESS OTHERWISE NOTED.

BASIS OF BEARINGS

THE BEARING N89°39'55"E OF THE LINE BETWEEN MONUMENTS AT THE EAST 1/4 CORNER AND THE WEST 1/4 CORNER OF SECTION 15, TOWNSHIP 2 NORTH, RANGE 3 EAST, MOUNT DIABLO BASE AND MERIDIAN, AS SHOWN ON PARCEL MAP MS 124-69 FILED SEPTEMBER 16, 1971 IN BOOK 18 OF PARCEL MAPS AT PAGES 23-24, OFFICIAL RECORDS OF CONTRA COSTA COUNTY.

LEGEND

- SUBDIVISION BOUNDARY
- LOT LINE
- - - - - EXISTING EASEMENT AS NOTED
- - - - - NEW EASEMENT AS NOTED
- MONUMENT LINE
- MONUMENT TIE LINE
- EXISTING LOT LINE

- FOUND POINT AS NOTED
- ⊙ FOUND EXISTING STREET MONUMENT (1), STAMPED RCE 25281

- LVME PUBLIC LEVEL MAINTENANCE EASEMENT
- PUE PUBLIC UTILITY EASEMENT
- PSLE PRIVATE SLOPE EASEMENT
- SDE STORM DRAIN EASEMENT
- WLE WATER LINE EASEMENT
- ⊕ CENTERLINE
- EX. EXISTING
- (M-M) MONUMENT TO MONUMENT
- (R) RADIAL BEARING
- (T) TOTAL
- FND FOUND
- IP IRON PIPE
- R/W RIGHT OF WAY
- STD STANDARD
- CCC COUNTY OF CONTRA COSTA
- (DATA)(1) RECORD DATA & REFERENCE
- SFNF SEARCHED FOR NOTHING FOUND
- NRF NO RECORD FOUND

Line Table		
Line	Bearing	Distance
L1	N04°15'41"W	45.00'
L2	N12°32'31"E	8.00'
L3	N29°20'42"E	45.00'
L4	N41°25'13"E	34.00'
L5	N89°33'23"W	45.00'
L6	N72°10'04"W	8.00'
L7	N49°42'16"W	45.00'

Curve Table			
Curve	Radius	Delta	Length
C1	45.00'	213°36'23"	167.77'
C2	45.00'	219°51'07"	172.67'
C3	400.00'	13°03'57"	91.22'
C4	200.00'	28°59'59"	101.23'

SEE SHEET 4

SEE SHEET 6

**SUBDIVISION 9582
DELTA COVES STREETS**

LANDS DESIGNATED AS SANDY LANE, DELTA COVES DRIVE, STONE ROAD, SHORELINE PLACE, SLOUGH PLACE, SEA DRIFT DRIVE, SEA MEADOW COURT, POINT PLACE, CHANNEL PLACE, ISLE PLACE, HALCYON PLACE, NAVIGATOR'S PLACE, WATERSIDE PLACE, GATEWAY ROAD, EDGEWATER DRIVE, EDGEWATER COURT, SEA GATE PLACE, SEAWARD COURT, GREY WHALE PLACE, WINDSWEEP ROAD, AND WEST WIND PLACE AS DESIGNATED ON SUBDIVISION 6013 (476 M 370), CONTRA COSTA COUNTY RECORDS

CONTRA COSTA COUNTY
CALIFORNIA

RUGGERI-JENSEN-AZAR
CIVIL ENGINEERS, PLANNERS, SURVEYORS
PLEASANTON, CALIFORNIA
SEPTEMBER 2021
SCALE: 1" = 50'

JOB NO. 131019

SHEET 5 OF 25 SHEETS

© 1/20/2021 12:09:19 SURVEY CAD FILES (DWG) MAP 131019-ANSWER.DWG 10/14/2021 10:56:43 AM ALAN MULLEN

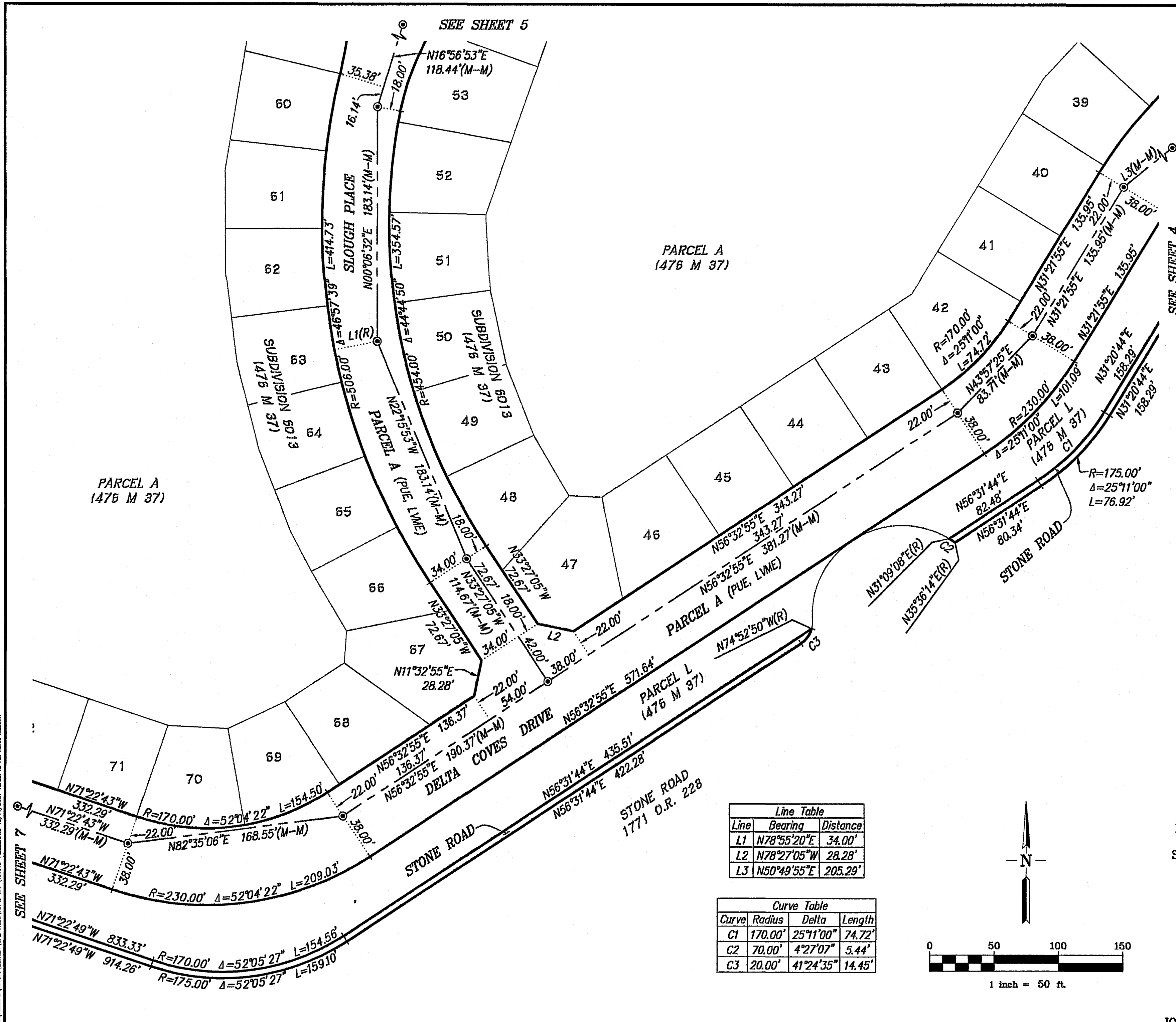

SEE SHEET 5

NOTE:

1. ALL MONUMENT TIE LINES ARE AT RIGHT ANGLES TO THE MONUMENT LINE UNLESS OTHERWISE NOTED.

BASIS OF BEARINGS

THE BEARING N89°39'55"E OF THE LINE BETWEEN MONUMENTS AT THE EAST 1/4 CORNER AND THE WEST 1/4 CORNER OF SECTION 15, TOWNSHIP 2 NORTH, RANGE 3 EAST, MOUNT DIABLO BASE AND MERIDIAN, AS SHOWN ON PARCEL MAP MS 124-69 FILED SEPTEMBER 16, 1971 IN BOOK 18 OF PARCEL MAPS AT PAGES 23-24, OFFICIAL RECORDS OF CONTRA COSTA COUNTY.

LEGEND

- SUBDIVISION BOUNDARY
- LOT LINE
- EXISTING EASEMENT AS NOTED
- NEW EASEMENT AS NOTED
- MONUMENT LINE
- MONUMENT TIE LINE
- EXISTING LOT LINE

- FOUND POINT AS NOTED
- FOUND EXISTING STREET MONUMENT (1), STAMPED RCE 25281

- LVME PUBLIC LEVEL MAINTENANCE EASEMENT
- PUE PUBLIC UTILITY EASEMENT
- PSLE PRIVATE SLOPE EASEMENT
- SDE STORM DRAIN EASEMENT
- WLE WATER LINE EASEMENT
- ⊕ CENTERLINE
- EX. EXISTING
- (M-M) MONUMENT TO MONUMENT
- (R) RADIAL BEARING
- (T) TOTAL
- FND FOUND
- IP IRON PIPE
- R/W RIGHT OF WAY
- STD STANDARD
- CCC COUNTY OF CONTRA COSTA
- (DATA)(1) RECORD DATA & REFERENCE
- SFNF SEARCHED FOR NOTHING FOUND
- NRF NO RECORD FOUND

**SUBDIVISION 9582
DELTA COVES STREETS**

LANDS DESIGNATED AS SANDY LANE, DELTA COVES DRIVE, STONE ROAD, SHORELINE PLACE, SLOUGH PLACE, SEA DRIFT DRIVE, SEA MEADOW COURT, POINT PLACE, CHANNEL PLACE, ISLE PLACE, HALCYON PLACE, NAVIGATOR'S PLACE, WATERSIDE PLACE, GATEWAY ROAD, EDGEWATER DRIVE, EDGEWATER COURT, SEA GATE PLACE, SEAWARD COURT, GREY WHALE PLACE, WINDSWEEP ROAD, AND WEST WIND PLACE AS DESIGNATED ON SUBDIVISION 6013 (476 M 370), CONTRA COSTA COUNTY RECORDS

CONTRA COSTA COUNTY
CALIFORNIA

RUGGERI-JENSEN-AZAR
CIVIL ENGINEERS, PLANNERS, SURVEYORS
PLEASANTON, CALIFORNIA
SEPTEMBER 2021
SCALE: 1" = 50'

Line Table

Line	Bearing	Distance
L1	N78°55'20"E	34.00'
L2	N78°27'05"W	28.28'
L3	N50°49'55"E	205.29'

Curve Table

Curve	Radius	Delta	Length
C1	170.00'	25°11'00"	74.72'
C2	70.00'	4°27'07"	5.44'
C3	20.00'	41°24'35"	14.45'

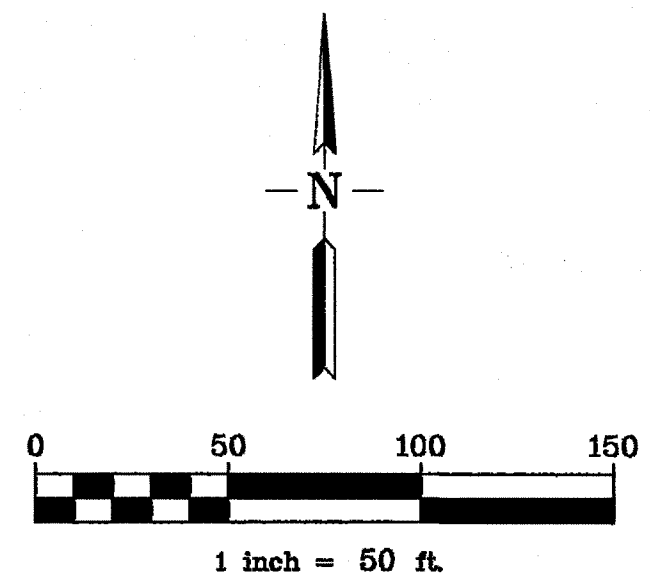

SEE SHEET 8

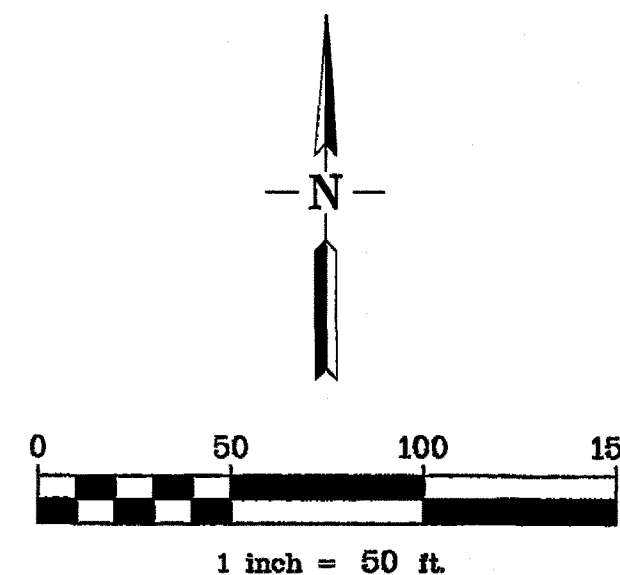

NOTE:

1. ALL MONUMENT TIE LINES ARE AT RIGHT ANGLES TO THE MONUMENT LINE UNLESS OTHERWISE NOTED.

BASIS OF BEARINGS

THE BEARING N89°39'55"E OF THE LINE BETWEEN MONUMENTS AT THE EAST 1/4 CORNER AND THE WEST 1/4 CORNER OF SECTION 15, TOWNSHIP 2 NORTH, RANGE 3 EAST, MOUNT DIABLO BASE AND MERIDIAN, AS SHOWN ON PARCEL MAP MS 124-69 FILED SEPTEMBER 16, 1971 IN BOOK 18 OF PARCEL MAPS AT PAGES 23-24, OFFICIAL RECORDS OF CONTRA COSTA COUNTY.

LEGEND

	SUBDIVISION BOUNDARY
	LOT LINE
	EXISTING EASEMENT AS NOTED
	NEW EASEMENT AS NOTED
	MONUMENT LINE
	MONUMENT TIE LINE
	EXISTING LOT LINE
	FOUND POINT AS NOTED
	FOUND EXISTING STREET MONUMENT (1), STAMPED RCE 25281
LVME	PUBLIC LEVEE MAINTENANCE EASEMENT
PUE	PUBLIC UTILITY EASEMENT
PSLE	PRIVATE SLOPE EASEMENT
SDE	STORM DRAIN EASEMENT
WLE	WATER LINE EASEMENT
CL	CENTERLINE
EX	EXISTING
(M-M)	MONUMENT TO MONUMENT
(R)	RADIAL BEARING
(T)	TOTAL
FND	FOUND
IP	IRON PIPE
R/W	RIGHT OF WAY
STD	STANDARD
CCC	COUNTY OF CONTRA COSTA
(DATA)(1)	RECORD DATA & REFERENCE
SFNF	SEARCHED FOR NOTHING FOUND
NRF	NO RECORD FOUND

**SUBDIVISION 9582
DELTA COVES STREETS**

LANDS DESIGNATED AS SANDY LANE, DELTA COVES DRIVE, STONE ROAD, SHORELINE PLACE, SLOUGH PLACE, SEA DRIFT DRIVE, SEA MEADOW COURT, POINT PLACE, CHANNEL PLACE, ISLE PLACE, HALCYON PLACE, NAVIGATOR'S PLACE, WATERSIDE PLACE, GATEWAY ROAD, EDGEWATER DRIVE, EDGEWATER COURT, SEA GATE PLACE, SEAWARD COURT, GREY WHALE PLACE, WINDSWEEP ROAD, AND WEST WIND PLACE AS DESIGNATED ON SUBDIVISION 6013 (476 M 370), CONTRA COSTA COUNTY RECORDS

CONTRA COSTA COUNTY
CALIFORNIA

RUGGERI-JENSEN-AZAR
CIVIL ENGINEERS, PLANNERS, SURVEYORS
PLEASANTON, CALIFORNIA
SEPTEMBER 2021
SCALE: 1" = 50'

G:\LABOR\131019\131019 SURVEY\CAD FILES\FINAL MAP\131019-PROSODING 10/14/2021 10:52:14 AM ALAN MILLER

Line	Bearing	Distance
L1	N62°59'40"E	28.28'
L2	N27°00'20"W	28.28'
L3	N72°00'20"W	7.82'
L4	N59°51'09"E	22.00'
L5	N59°51'09"E	38.00'
L6	N72°00'20"W	3.82'
L7	N71°22'49"W	41.78'
L8	N71°22'49"W	39.14'
L9	N66°57'46"E	30.17'

Curve	Radius	Delta	Length
C1	170.00'	7°18'42"	21.69'

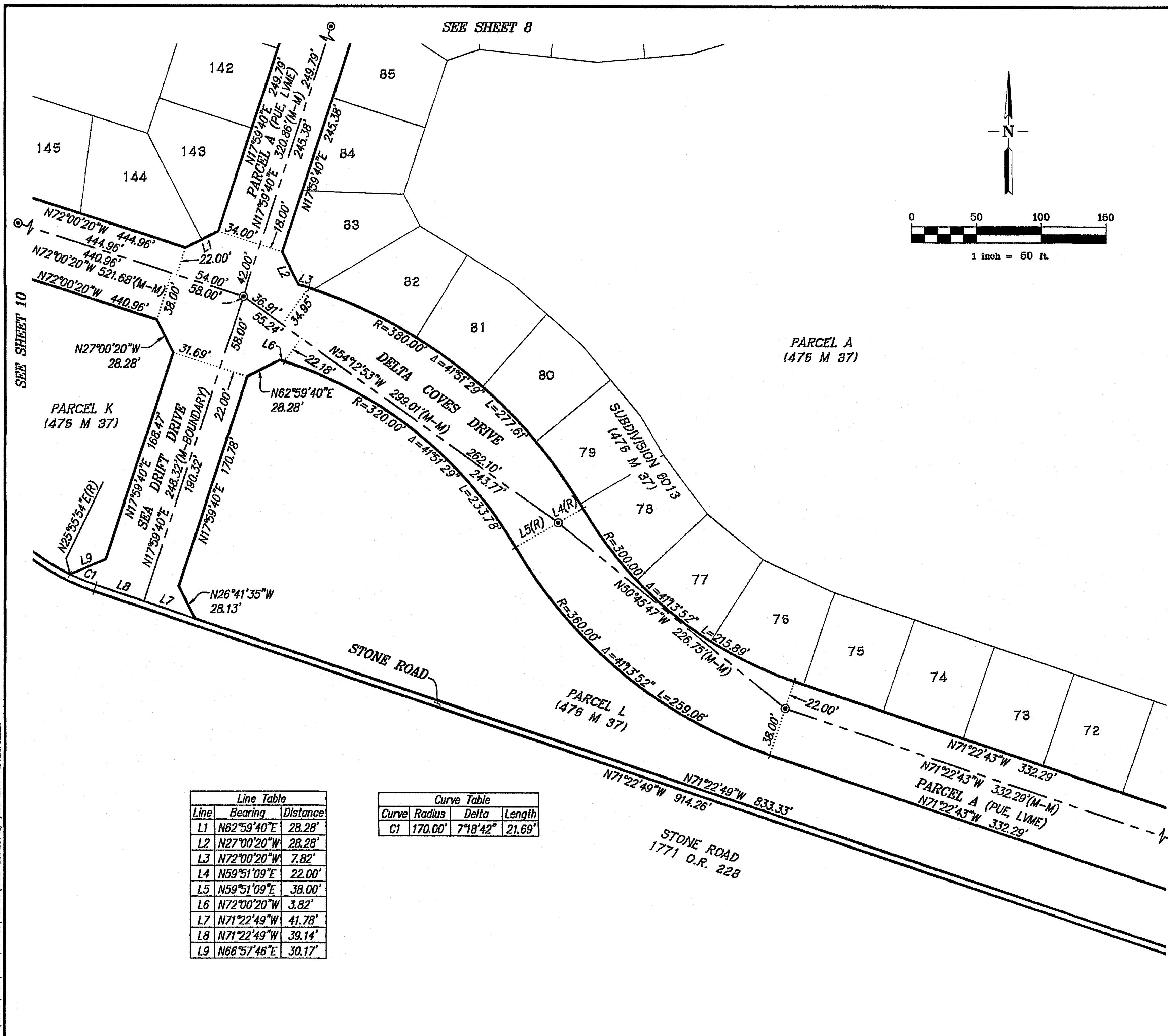

C:\MAPS\131019\SURVEY\DWG\FILES\131019-9582.DWG 10/14/2021 10:58:11 AM ALAN MULLEN

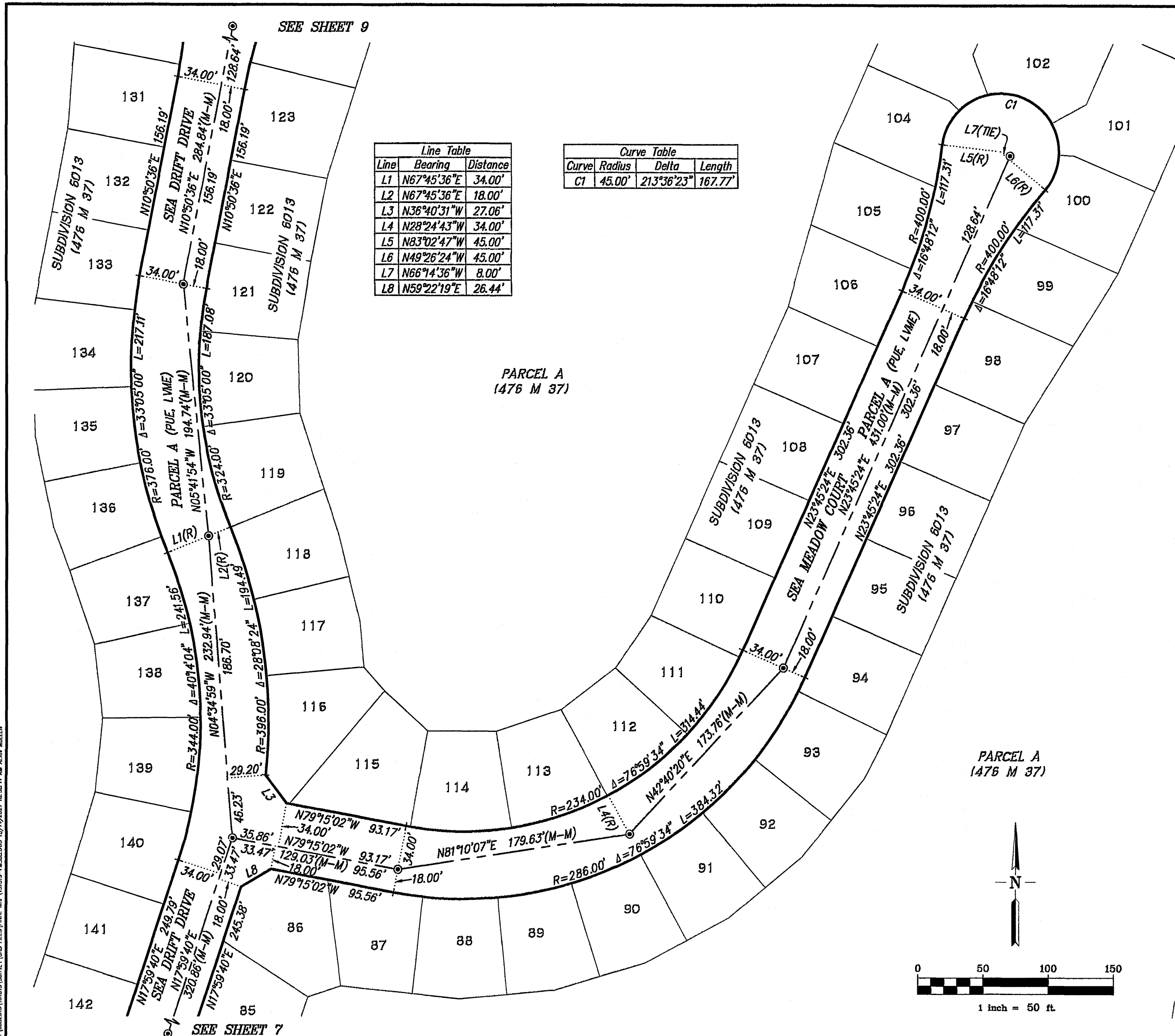

Line Table		
Line	Bearing	Distance
L1	N67°45'36"E	34.00'
L2	N67°45'36"E	18.00'
L3	N36°40'31"W	27.06'
L4	N28°24'43"W	34.00'
L5	N83°02'47"W	45.00'
L6	N49°26'24"W	45.00'
L7	N66°14'36"W	8.00'
L8	N59°22'19"E	26.44'

Curve Table			
Curve	Radius	Delta	Length
C1	45.00'	213°36'23"	167.77'

NOTE:

1. ALL MONUMENT TIE LINES ARE AT RIGHT ANGLES TO THE MONUMENT LINE UNLESS OTHERWISE NOTED.

BASIS OF BEARINGS

THE BEARING N89°39'55"E OF THE LINE BETWEEN MONUMENTS AT THE EAST 1/4 CORNER AND THE WEST 1/4 CORNER OF SECTION 15, TOWNSHIP 2 NORTH, RANGE 3 EAST, MOUNT DIABLO BASE AND MERIDIAN, AS SHOWN ON PARCEL MAP MS 124-69 FILED SEPTEMBER 16, 1971 IN BOOK 18 OF PARCEL MAPS AT PAGES 23-24, OFFICIAL RECORDS OF CONTRA COSTA COUNTY.

LEGEND

- SUBDIVISION BOUNDARY
 - LOT LINE
 - - - - - EXISTING EASEMENT AS NOTED
 - - - - - NEW EASEMENT AS NOTED
 - MONUMENT LINE
 - MONUMENT TIE LINE
 - EXISTING LOT LINE
- FOUND POINT AS NOTED
 - ⊙ FOUND EXISTING STREET MONUMENT (1), STAMPED RCE 25281
 - LVME PUBLIC LEVEL MAINTENANCE EASEMENT
 - PUE PUBLIC UTILITY EASEMENT
 - PSLE PRIVATE SLOPE EASEMENT
 - SDE STORM DRAIN EASEMENT
 - WLE WATER LINE EASEMENT
 - Ⓢ CENTERLINE
 - EX. EXISTING
 - (M-M) MONUMENT TO MONUMENT
 - (R) RADIAL BEARING
 - (T) TOTAL
 - FND FOUND
 - IP IRON PIPE
 - R/W RIGHT OF WAY
 - STD STANDARD
 - CCC COUNTY OF CONTRA COSTA
 - (DATA)(1) RECORD DATA & REFERENCE
 - SFNF SEARCHED FOR NOTHING FOUND
 - NRF NO RECORD FOUND

**SUBDIVISION 9582
DELTA COVES STREETS**

LANDS DESIGNATED AS SANDY LANE, DELTA COVES DRIVE, STONE ROAD, SHORELINE PLACE, SLOUGH PLACE, SEA DRIFT DRIVE, SEA MEADOW COURT, POINT PLACE, CHANNEL PLACE, ISLE PLACE, HALCYON PLACE, NAVIGATOR'S PLACE, WATERSIDE PLACE, GATEWAY ROAD, EDGEWATER DRIVE, EDGEWATER COURT, SEA GATE PLACE, SEAWARD COURT, GREY WHALE PLACE, WINDSWEEP ROAD, AND WEST WIND PLACE AS DESIGNATED ON SUBDIVISION 6013 (476 M 37), CONTRA COSTA COUNTY RECORDS

CONTRA COSTA COUNTY
CALIFORNIA

RUGGERI-JENSEN-AZAR
CIVIL ENGINEERS, PLANNERS, SURVEYORS
PLEASANTON, CALIFORNIA
SEPTEMBER 2021
SCALE: 1" = 50'

G:\AEC\2021\131019\SHM\A\CAD FILES\FINAL MAP\131019-FMS.DWG 10/14/2021 10:58:39 AM ALAN MULLEN

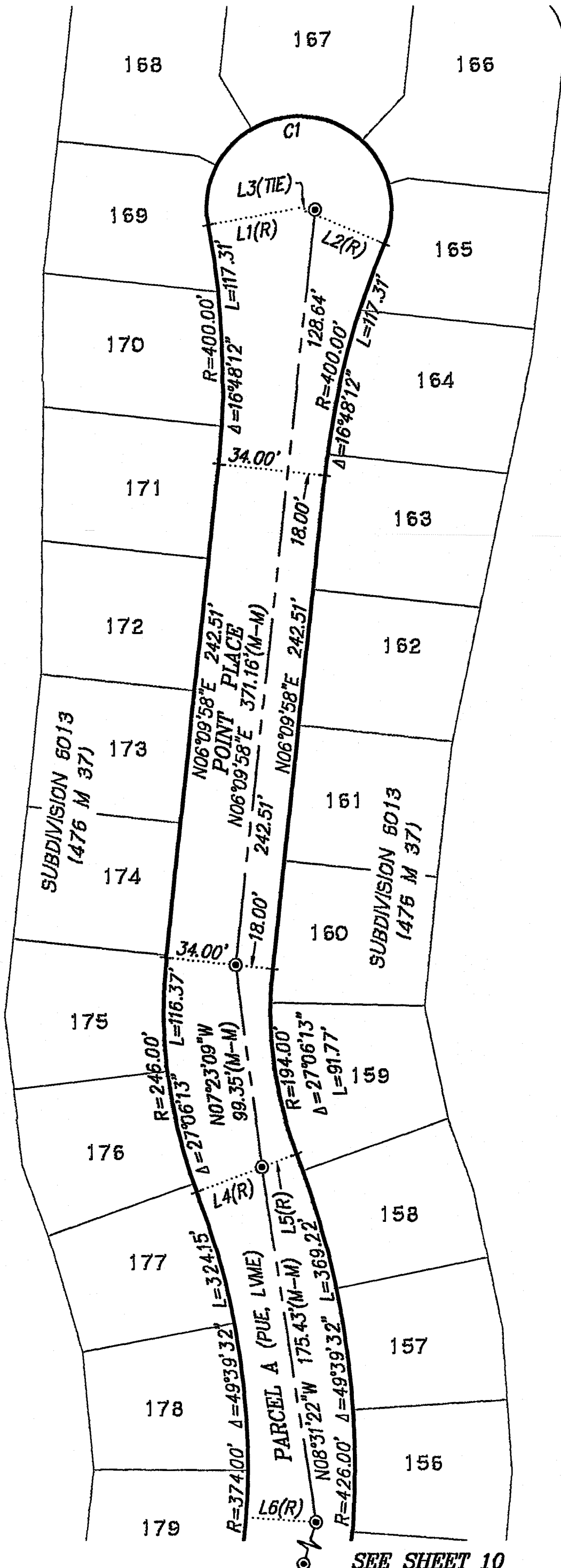

SEE SHEET 10

Line Table		
Line	Bearing	Distance
L1	N79°21'46"E	45.00'
L2	N67°01'51"W	45.00'
L3	N83°50'02"W	8.00'
L4	N69°03'45"E	34.00'
L5	N69°03'45"E	18.00'
L6	N86°06'29"W	34.00'
L7	N84°02'24"E	45.00'
L8	N62°21'12"W	45.00'
L9	N79°09'24"W	8.00'
L10	N67°45'36"E	34.00'
L11	N67°45'36"E	18.00'

Curve Table			
Curve	Radius	Delta	Length
C1	45.00'	213°36'23"	167.77'

PARCEL A
(476 M 37)

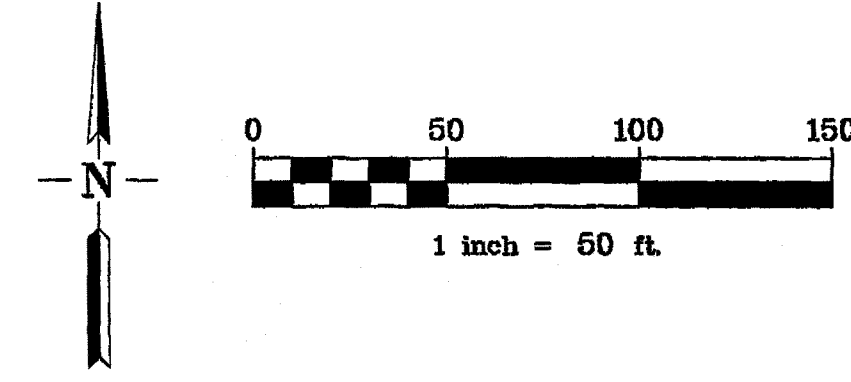

NOTE:

1. ALL MONUMENT TIE LINES ARE AT RIGHT ANGLES TO THE MONUMENT LINE UNLESS OTHERWISE NOTED.

BASIS OF BEARINGS

THE BEARING N89°39'55"E OF THE LINE BETWEEN MONUMENTS AT THE EAST 1/4 CORNER AND THE WEST 1/4 CORNER OF SECTION 15, TOWNSHIP 2 NORTH, RANGE 3 EAST, MOUNT DIABLO BASE AND MERIDIAN, AS SHOWN ON PARCEL MAP MS 124-69 FILED SEPTEMBER 16, 1971 IN BOOK 18 OF PARCEL MAPS AT PAGES 23-24, OFFICIAL RECORDS OF CONTRA COSTA COUNTY.

LEGEND

- SUBDIVISION BOUNDARY
- LOT LINE
- EXISTING EASEMENT AS NOTED
- NEW EASEMENT AS NOTED
- MONUMENT LINE
- MONUMENT TIE LINE
- EXISTING LOT LINE
- FOUND POINT AS NOTED
- FOUND EXISTING STREET MONUMENT (1), STAMPED RCE 25281
- LVME PUBLIC LEVEL MAINTENANCE EASEMENT
- PUE PUBLIC UTILITY EASEMENT
- PSLE PRIVATE SLOPE EASEMENT
- SDE STORM DRAIN EASEMENT
- WLE WATER LINE EASEMENT
- CL CENTERLINE
- EX EXISTING
- (M-M) MONUMENT TO MONUMENT
- (R) RADIAL BEARING
- (T) TOTAL
- FND FOUND
- IP IRON PIPE
- R/W RIGHT OF WAY
- STD STANDARD
- CCC COUNTY OF CONTRA COSTA
- (DATA)(1) RECORD DATA & REFERENCE
- SFNF SEARCHED FOR NOTHING FOUND
- NRF NO RECORD FOUND

**SUBDIVISION 9582
DELTA COVES STREETS**

LANDS DESIGNATED AS SANDY LANE, DELTA COVES DRIVE, STONE ROAD, SHORELINE PLACE, SLOUGH PLACE, SEA DRIFT DRIVE, SEA MEADOW COURT, POINT PLACE, CHANNEL PLACE, ISLE PLACE, HALCYON PLACE, NAVIGATOR'S PLACE, WATERSIDE PLACE, GATEWAY ROAD, EDGEWATER DRIVE, EDGEWATER COURT, SEA GATE PLACE, SEAWARD COURT, GREY WHALE PLACE, WINDSWEEP ROAD, AND WEST WIND PLACE AS DESIGNATED ON SUBDIVISION 6013 (476 M 370), CONTRA COSTA COUNTY RECORDS

CONTRA COSTA COUNTY
CALIFORNIA
RUGGERI-JENSEN-AZAR
CIVIL ENGINEERS, PLANNERS, SURVEYORS
PLEASANTON, CALIFORNIA
SEPTEMBER 2021
SCALE: 1" = 50'

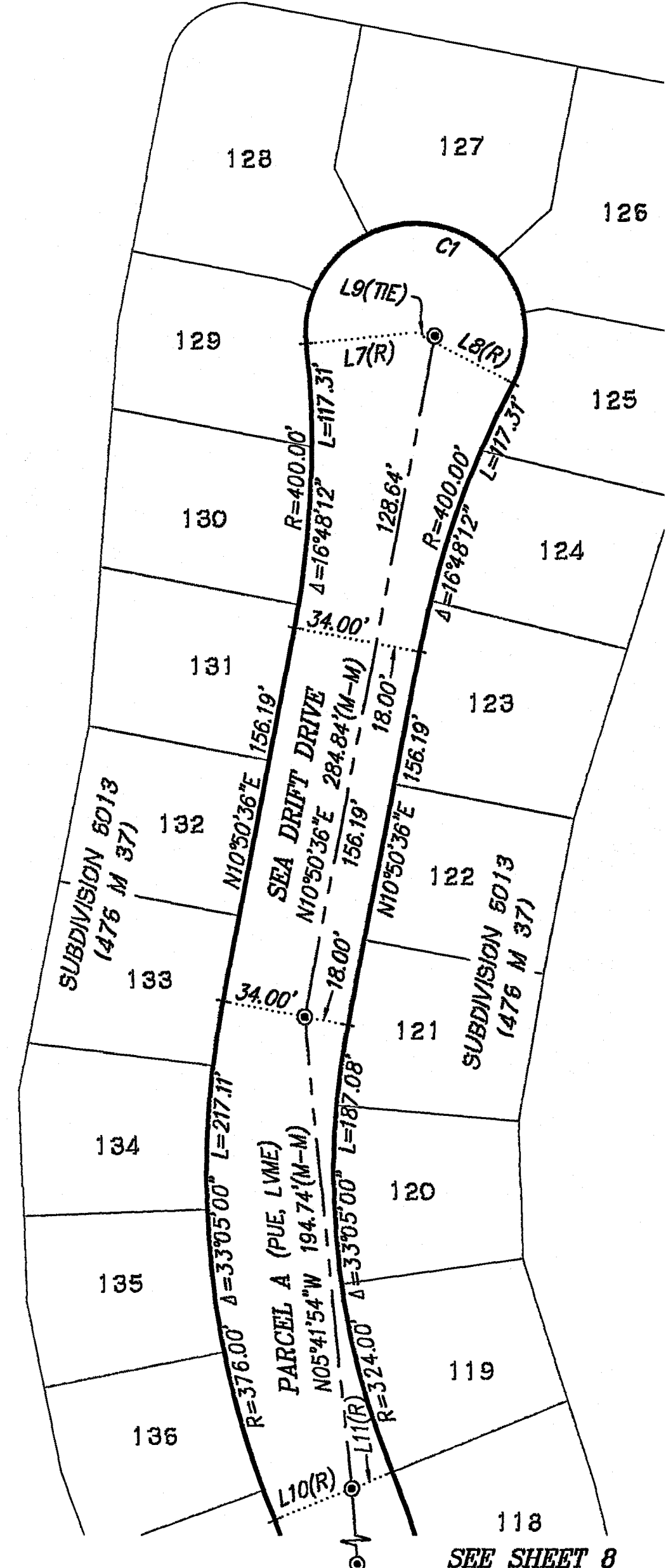

SEE SHEET 8

SEE SHEET 8

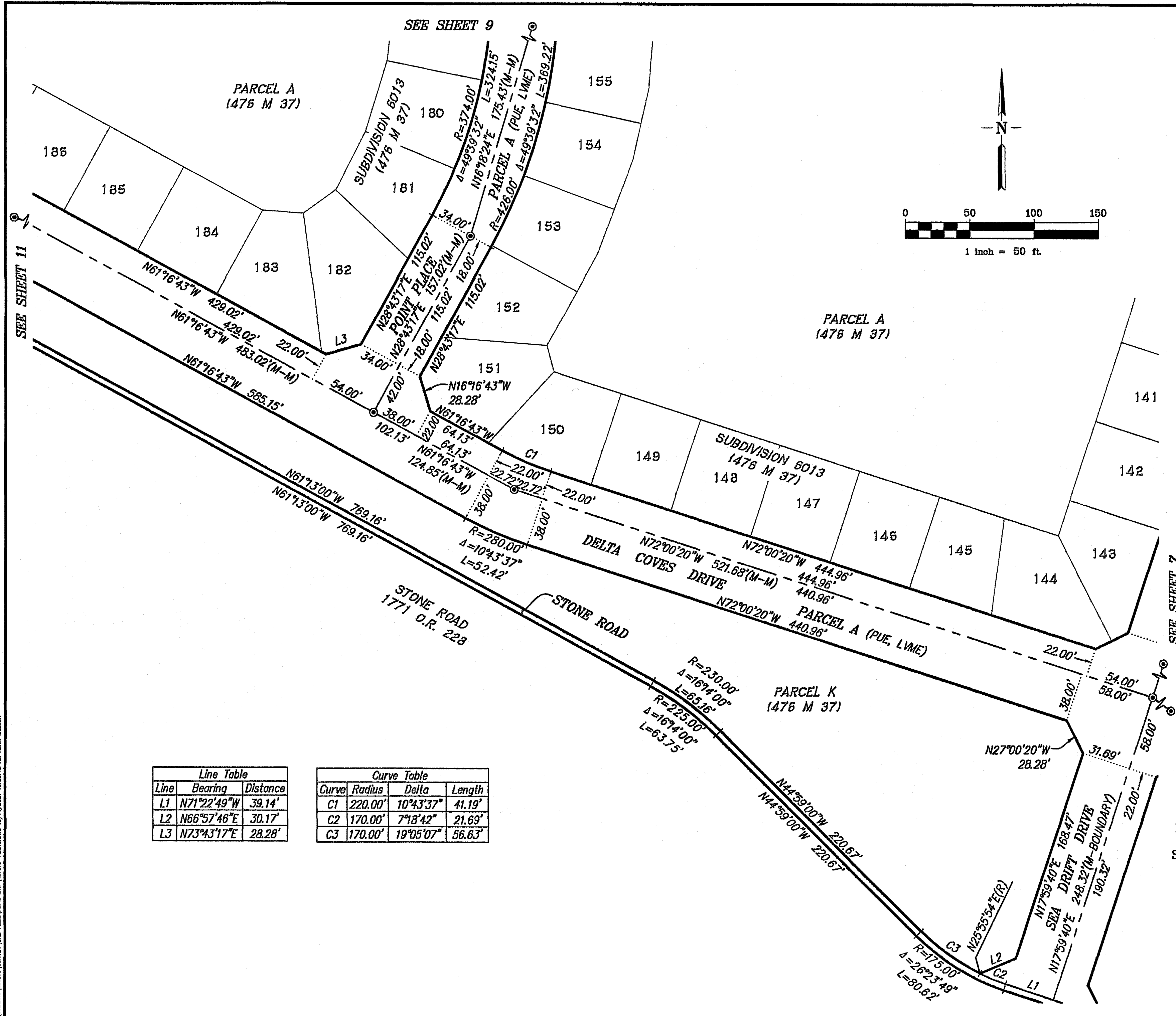

NOTE:

1. ALL MONUMENT TIE LINES ARE AT RIGHT ANGLES TO THE MONUMENT LINE UNLESS OTHERWISE NOTED.

BASIS OF BEARINGS

THE BEARING N89°39'55"E OF THE LINE BETWEEN MONUMENTS AT THE EAST 1/4 CORNER AND THE WEST 1/4 CORNER OF SECTION 15, TOWNSHIP 2 NORTH, RANGE 3 EAST, MOUNT DIABLO BASE AND MERIDIAN, AS SHOWN ON PARCEL MAP MS 124-69 FILED SEPTEMBER 16, 1971 IN BOOK 18 OF PARCEL MAPS AT PAGES 23-24, OFFICIAL RECORDS OF CONTRA COSTA COUNTY.

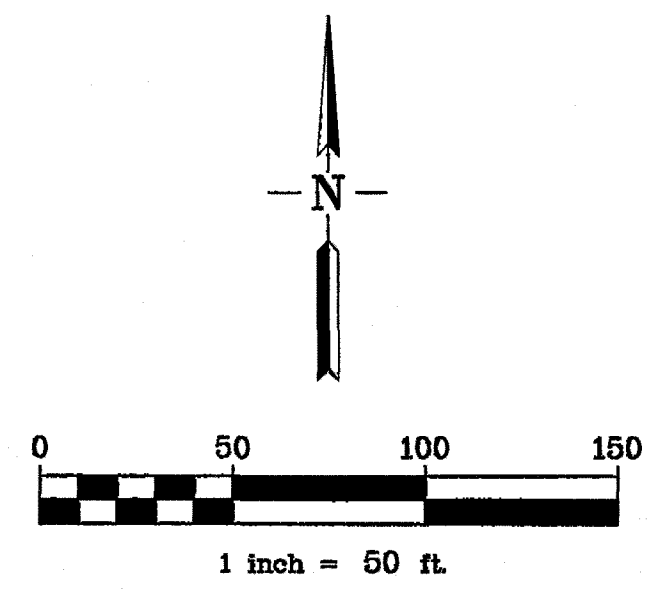

LEGEND

- SUBDIVISION BOUNDARY
- LOT LINE
- EXISTING EASEMENT AS NOTED
- NEW EASEMENT AS NOTED
- MONUMENT LINE
- MONUMENT TIE LINE
- EXISTING LOT LINE
- FOUND POINT AS NOTED
- FOUND EXISTING STREET MONUMENT (1), STAMPED RCE 25281
- LVME PUBLIC LEVEL MAINTENANCE EASEMENT
- PUE PUBLIC UTILITY EASEMENT
- PSLE PRIVATE SLOPE EASEMENT
- SDE STORM DRAIN EASEMENT
- WLE WATER LINE EASEMENT
- Ⓢ CENTERLINE
- EX. EXISTING
- (M-M) MONUMENT TO MONUMENT
- (R) RADIAL BEARING
- (T) TOTAL
- FND FOUND
- IP IRON PIPE
- R/W RIGHT OF WAY
- STD STANDARD
- CCC COUNTY OF CONTRA COSTA
- (DATA)(1) RECORD DATA & REFERENCE
- SFNF SEARCHED FOR NOTHING FOUND
- NRF NO RECORD FOUND

**SUBDIVISION 9582
DELTA COVES STREETS**

LANDS DESIGNATED AS SANDY LANE, DELTA COVES DRIVE, STONE ROAD, SHORELINE PLACE, SLOUGH PLACE, SEA DRIFT DRIVE, SEA MEADOW COURT, POINT PLACE, CHANNEL PLACE, ISLE PLACE, HALCYON PLACE, NAVIGATOR'S PLACE, WATERSIDE PLACE, GATEWAY ROAD, EDGEWATER DRIVE, EDGEWATER COURT, SEA GATE PLACE, SEAWARD COURT, GREY WHALE PLACE, WINDSWEEP ROAD, AND WEST WIND PLACE AS DESIGNATED ON SUBDIVISION 6013 (476 M 370), CONTRA COSTA COUNTY RECORDS

CONTRA COSTA COUNTY
CALIFORNIA
RUGGERI-JENSEN-AZAR
CIVIL ENGINEERS, PLANNERS, SURVEYORS
PLEASANTON, CALIFORNIA
SEPTEMBER 2021
SCALE: 1" = 50'

Line Table		
Line	Bearing	Distance
L1	N71°22'49"W	39.14'
L2	N66°57'46"E	30.17'
L3	N73°43'17"E	28.28'

Curve Table			
Curve	Radius	Delta	Length
C1	220.00'	10°43'37"	41.19'
C2	170.00'	7°18'42"	21.69'
C3	170.00'	19°05'07"	56.63'

C:\LDB2021\131019 SURVEY\CAD FILES\DWG MAP\131019-MS12019.DWG 10/14/2021 10:58:16 AM ALAN MULLEN

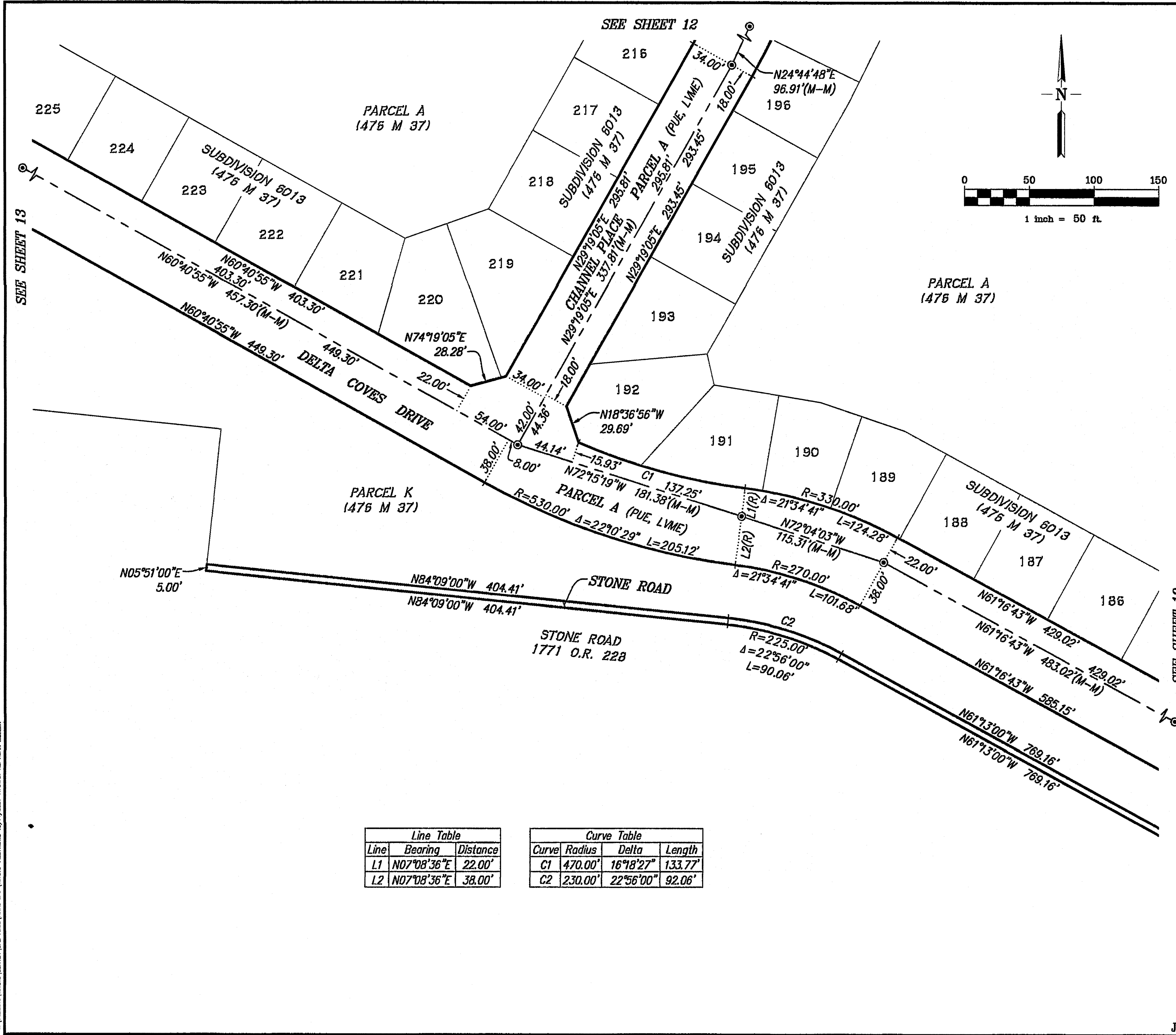

NOTE:

1. ALL MONUMENT TIE LINES ARE AT RIGHT ANGLES TO THE MONUMENT LINE UNLESS OTHERWISE NOTED.

BASIS OF BEARINGS

THE BEARING N89°39'55"E OF THE LINE BETWEEN MONUMENTS AT THE EAST 1/4 CORNER AND THE WEST 1/4 CORNER OF SECTION 15, TOWNSHIP 2 NORTH, RANGE 3 EAST, MOUNT DIABLO BASE AND MERIDIAN, AS SHOWN ON PARCEL MAP MS 124-69 FILED SEPTEMBER 16, 1971 IN BOOK 18 OF PARCEL MAPS AT PAGES 23-24, OFFICIAL RECORDS OF CONTRA COSTA COUNTY.

LEGEND

- SUBDIVISION BOUNDARY
- LOT LINE
- - - - - EXISTING EASEMENT AS NOTED
- - - - - NEW EASEMENT AS NOTED
- MONUMENT LINE
- MONUMENT TIE LINE
- EXISTING LOT LINE
- FOUND POINT AS NOTED
- ⊙ FOUND EXISTING STREET MONUMENT (1), STAMPED RCE 25281
- LVME PUBLIC LEVEE MAINTENANCE EASEMENT
- PUE PUBLIC UTILITY EASEMENT
- PSLE PRIVATE SLOPE EASEMENT
- SDE STORM DRAIN EASEMENT
- WLE WATER LINE EASEMENT
- ⊕ CENTERLINE
- EX EXISTING
- (M-M) MONUMENT TO MONUMENT
- (R) RADIAL BEARING
- (T) TOTAL
- FND FOUND
- IP IRON PIPE
- R/W RIGHT OF WAY
- STD STANDARD
- CCC COUNTY OF CONTRA COSTA
- (DATA)(1) RECORD DATA & REFERENCE
- SFNF SEARCHED FOR NOTHING FOUND
- NRF NO RECORD FOUND

**SUBDIVISION 9582
DELTA COVES STREETS**

LANDS DESIGNATED AS SANDY LANE, DELTA COVES DRIVE, STONE ROAD, SHORELINE PLACE, SLOUGH PLACE, SEA DRIFT DRIVE, SEA MEADOW COURT, POINT PLACE, CHANNEL PLACE, ISLE PLACE, HALCYON PLACE, NAVIGATOR'S PLACE, WATERSIDE PLACE, GATEWAY ROAD, EDGEWATER DRIVE, EDGEWATER COURT, SEA GATE PLACE, SEAWARD COURT, GREY WHALE PLACE, WINDSWEEP ROAD, AND WEST WIND PLACE AS DESIGNATED ON SUBDIVISION 6013 (476 M 370), CONTRA COSTA COUNTY RECORDS

CONTRA COSTA COUNTY
CALIFORNIA
RUGGERI-JENSEN-AZAR
CIVIL ENGINEERS, PLANNERS, SURVEYORS
PLEASANTON, CALIFORNIA
SEPTEMBER 2021
SCALE: 1" = 50'

Line Table		
Line	Bearing	Distance
L1	N07°08'36"E	22.00'
L2	N07°08'36"E	38.00'

Curve Table			
Curve	Radius	Delta	Length
C1	470.00'	16°18'27"	133.77'
C2	230.00'	22°56'00"	92.06'

G:\2021\131019\SURVEY\131019-FAST.DWG 10/14/2021 11:01:31 AM ALAN MILLER

C:\WORK\131019\SURVEY\LOAD FILES\FINAL MAP\131019-PRST2.DWG 10/14/2021 11:02:02 AM ALAN MULLEN

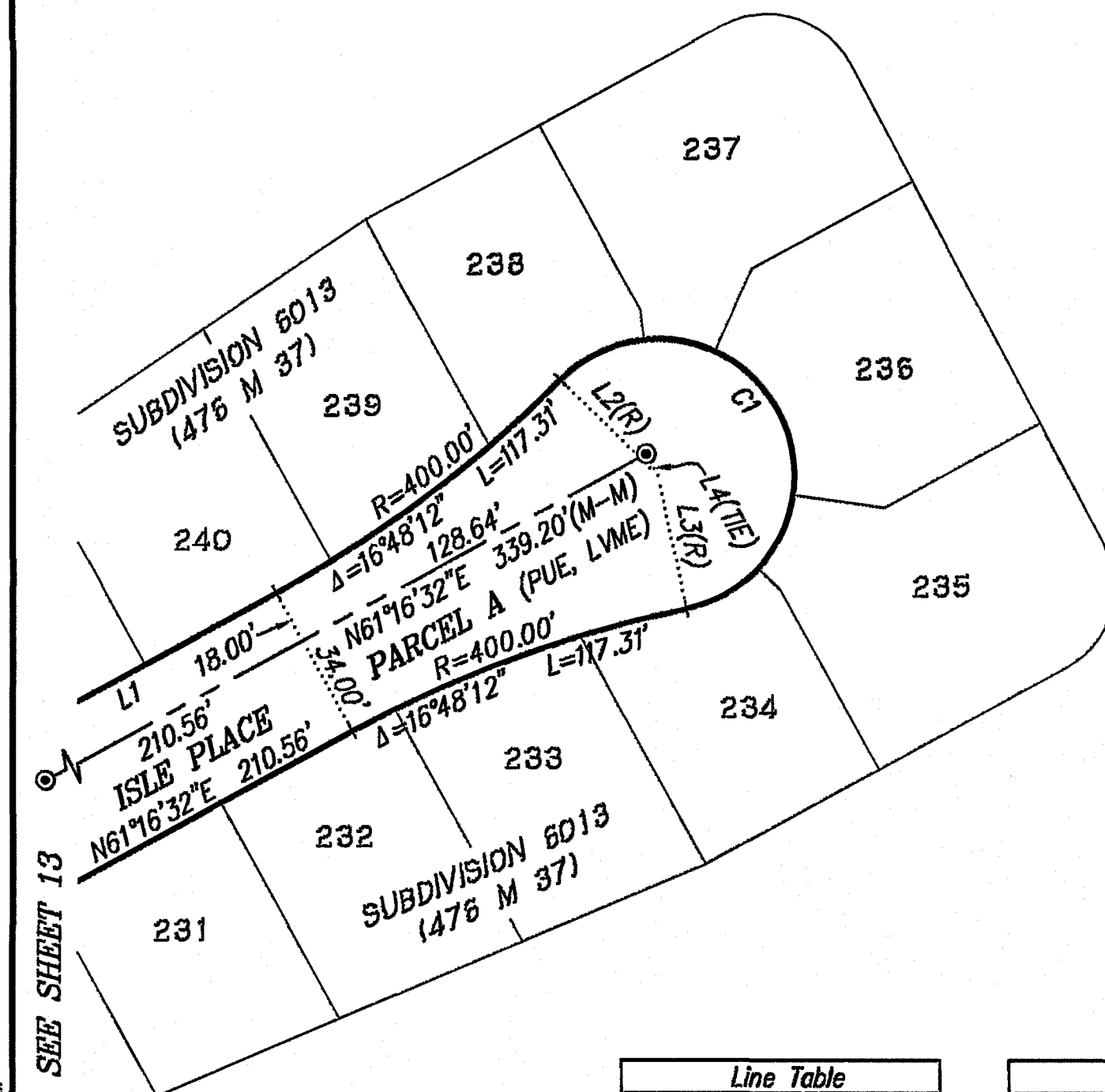

Line	Bearing	Distance
L1	N61°16'32"E	210.56'
L2	N45°31'40"W	45.00'
L3	N11°55'17"W	45.00'
L4	N28°43'28"W	8.00'
L5	N29°19'05"E	295.81'
L6	N29°19'05"E	337.81'
L7	N29°19'05"E	293.45'
L8	N86°37'39"W	45.00'
L9	N53°01'16"W	45.00'
L10	N69°49'28"W	8.00'

Curve	Radius	Delta	Length
C1	45.00'	213°36'23"	167.77'
C2	574.00'	9°08'33"	91.59'
C3	626.00'	9°08'33"	99.89'

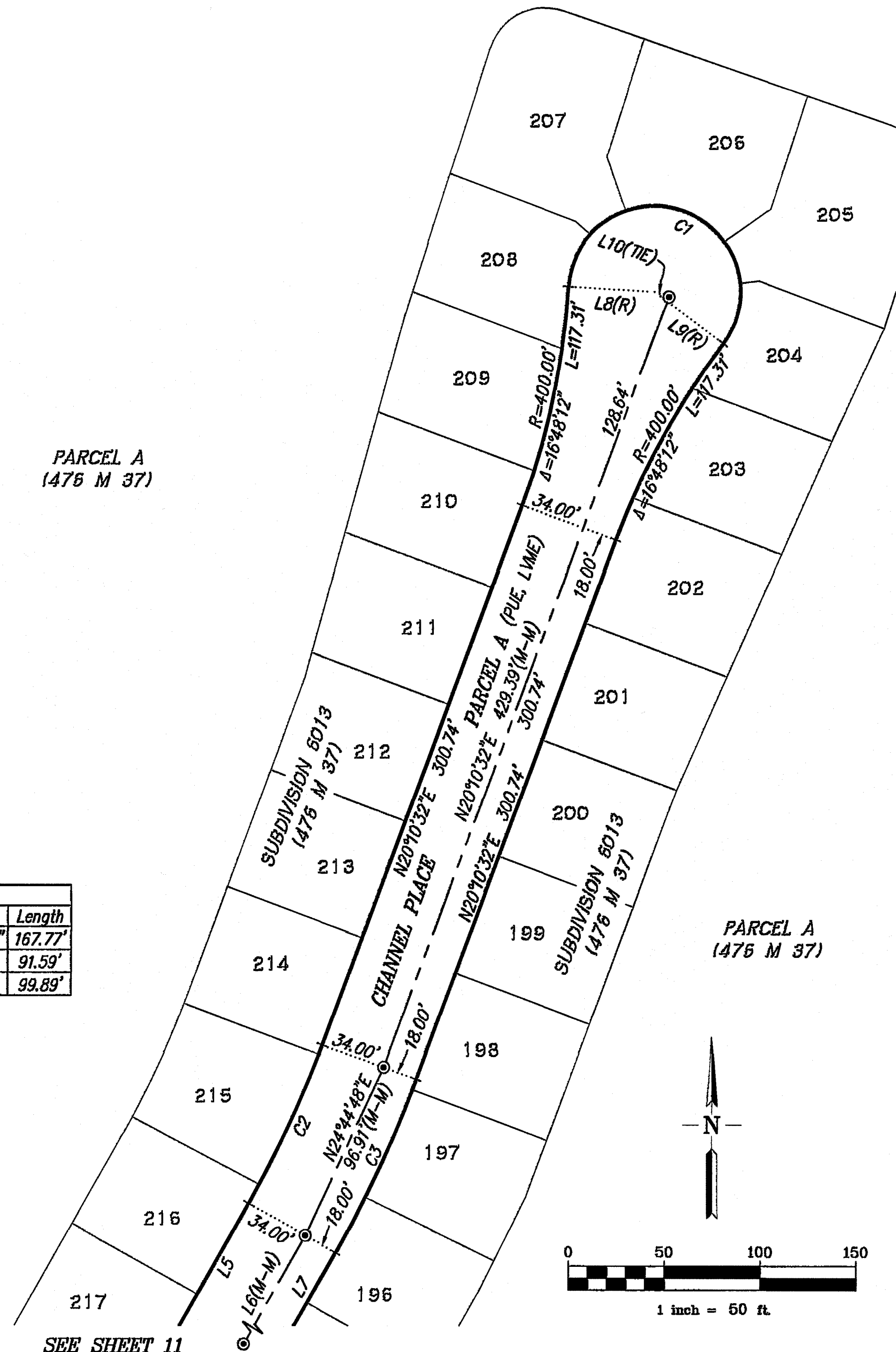

NOTE:

1. ALL MONUMENT TIE LINES ARE AT RIGHT ANGLES TO THE MONUMENT LINE UNLESS OTHERWISE NOTED.

BASIS OF BEARINGS

THE BEARING N89°39'55"E OF THE LINE BETWEEN MONUMENTS AT THE EAST 1/4 CORNER AND THE WEST 1/4 CORNER OF SECTION 15, TOWNSHIP 2 NORTH, RANGE 3 EAST, MOUNT DIABLO BASE AND MERIDIAN, AS SHOWN ON PARCEL MAP MS 124-69 FILED SEPTEMBER 16, 1971 IN BOOK 18 OF PARCEL MAPS AT PAGES 23-24, OFFICIAL RECORDS OF CONTRA COSTA COUNTY.

LEGEND

- SUBDIVISION BOUNDARY
- LOT LINE
- EXISTING EASEMENT AS NOTED
- NEW EASEMENT AS NOTED
- MONUMENT LINE
- MONUMENT TIE LINE
- EXISTING LOT LINE
- FOUND POINT AS NOTED
- FOUND EXISTING STREET MONUMENT (1), STAMPED RCE 25281
- LVME PUBLIC LEVEE MAINTENANCE EASEMENT
- PUE PUBLIC UTILITY EASEMENT
- PSLE PRIVATE SLOPE EASEMENT
- SDE STORM DRAIN EASEMENT
- WLE WATER LINE EASEMENT
- ⊕ CENTERLINE
- EX. EXISTING
- (M-M) MONUMENT TO MONUMENT
- (R) RADIAL BEARING
- (T) TOTAL
- FND FOUND
- IP IRON PIPE
- R/W RIGHT OF WAY
- STD STANDARD
- CCC COUNTY OF CONTRA COSTA
- (DATA)(1) RECORD DATA & REFERENCE
- SFNF SEARCHED FOR NOTHING FOUND
- NRF NO RECORD FOUND

**SUBDIVISION 9582
DELTA COVES STREETS**

LANDS DESIGNATED AS SANDY LANE, DELTA COVES DRIVE, STONE ROAD, SHORELINE PLACE, SLOUGH PLACE, SEA DRIFT DRIVE, SEA MEADOW COURT, POINT PLACE, CHANNEL PLACE, ISLE PLACE, HALCYON PLACE, NAVIGATOR'S PLACE, WATERSIDE PLACE, GATEWAY ROAD, EDGEWATER DRIVE, EDGEWATER COURT, SEA GATE PLACE, SEAWARD COURT, GREY WHALE PLACE, WINDSWEEP ROAD, AND WEST WIND PLACE AS DESIGNATED ON SUBDIVISION 6013 (476 M 370), CONTRA COSTA COUNTY RECORDS

CONTRA COSTA COUNTY
CALIFORNIA

RUGGERI-JENSEN-AZAR
CIVIL ENGINEERS, PLANNERS, SURVEYORS
PLEASANTON, CALIFORNIA
SEPTEMBER 2021
SCALE: 1" = 50'

SEE SHEET 11

SEE SHEET 13

PARCEL M
(476 M 37)

NOT A PART

RANCH LANE
(PRIVATE)

RANCH LANE
(PRIVATE)

SEE SHEET 15

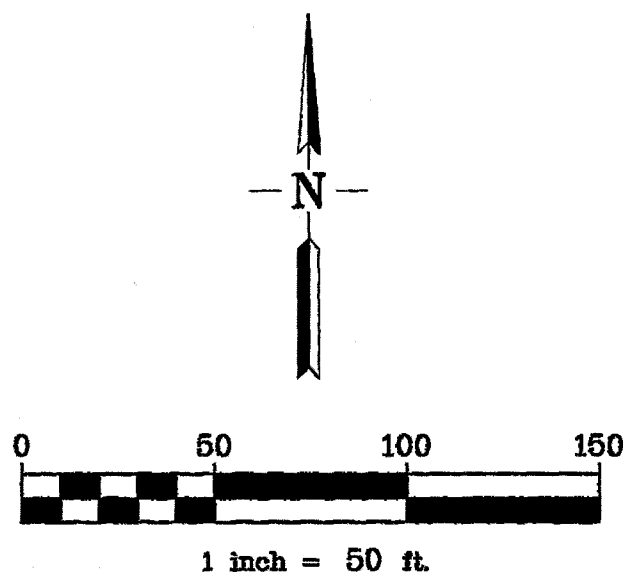

PARCEL A
(476 M 37)

NOTE:

1. ALL MONUMENT TIE LINES ARE AT RIGHT ANGLES TO THE MONUMENT LINE UNLESS OTHERWISE NOTED.

BASIS OF BEARINGS

THE BEARING N89°39'55"E OF THE LINE BETWEEN MONUMENTS AT THE EAST 1/4 CORNER AND THE WEST 1/4 CORNER OF SECTION 15, TOWNSHIP 2 NORTH, RANGE 3 EAST, MOUNT DIABLO BASE AND MERIDIAN, AS SHOWN ON PARCEL MAP MS 124-69 FILED SEPTEMBER 16, 1971 IN BOOK 18 OF PARCEL MAPS AT PAGES 23-24, OFFICIAL RECORDS OF CONTRA COSTA COUNTY.

LEGEND

- SUBDIVISION BOUNDARY
- LOT LINE
- EXISTING EASEMENT AS NOTED
- NEW EASEMENT AS NOTED
- MONUMENT LINE
- MONUMENT TIE LINE
- EXISTING LOT LINE
- FOUND POINT AS NOTED
- FOUND EXISTING STREET MONUMENT (1), STAMPED RCE 25281
- LVME PUBLIC LEVEL MAINTENANCE EASEMENT
- PUE PUBLIC UTILITY EASEMENT
- PSLE PRIVATE SLOPE EASEMENT
- SDE STORM DRAIN EASEMENT
- WLE WATER LINE EASEMENT
- Ⓢ CENTERLINE
- EX. EXISTING
- (M-M) MONUMENT TO MONUMENT
- (R) RADIAL BEARING
- (T) TOTAL
- FND FOUND
- IP IRON PIPE
- R/W RIGHT OF WAY
- STD STANDARD
- CCC COUNTY OF CONTRA COSTA
- (DATA)(1) RECORD DATA & REFERENCE
- SFNF SEARCHED FOR NOTHING FOUND
- NRF NO RECORD FOUND

**SUBDIVISION 9582
DELTA COVES STREETS**

LANDS DESIGNATED AS SANDY LANE, DELTA COVES DRIVE, STONE ROAD, SHORELINE PLACE, SLOUGH PLACE, SEA DRIFT DRIVE, SEA MEADOW COURT, POINT PLACE, CHANNEL PLACE, ISLE PLACE, HALCYON PLACE, NAVIGATOR'S PLACE, WATERSIDE PLACE, GATEWAY ROAD, EDGEWATER DRIVE, EDGEWATER COURT, SEA GATE PLACE, SEAWARD COURT, GREY WHALE PLACE, WINDSWEEP ROAD, AND WEST WIND PLACE AS DESIGNATED ON SUBDIVISION 6013 (476 M 370), CONTRA COSTA COUNTY RECORDS

CONTRA COSTA COUNTY
CALIFORNIA
RUGGERI-JENSEN-AZAR
CIVIL ENGINEERS, PLANNERS, SURVEYORS
PLEASANTON, CALIFORNIA
SEPTEMBER 2021
SCALE: 1"=50'

JOB NO. 131019

SHEET 13 OF 25 SHEETS

Line	Bearing	Distance
L1	N89°21'55"E	38.00'
L2	N89°21'55"E	22.00'
L3	N89°06'36"E	28.28'
L4	N44°06'36"E	33.07'
L5	N44°06'36"E	75.07'
L6	N44°06'36"E	32.97'

Curve	Radius	Delta	Length
C1	326.00'	17°09'56"	97.67'
C2	400.00'	16°48'12"	117.31'
C3	274.00'	17°09'56"	82.09'

C:\WORK\131019\131019-001\131019-001-FILED\131019-001-FILED.DWG 10/14/2021 11:02:28 AM ALAN MUELEN

G:\CADD\131019\SURVEY\CADD FILES\FINAL MAP\131019-RS\BUILDING 10/14/2021 11:02:54 AM ALAN MULLEN

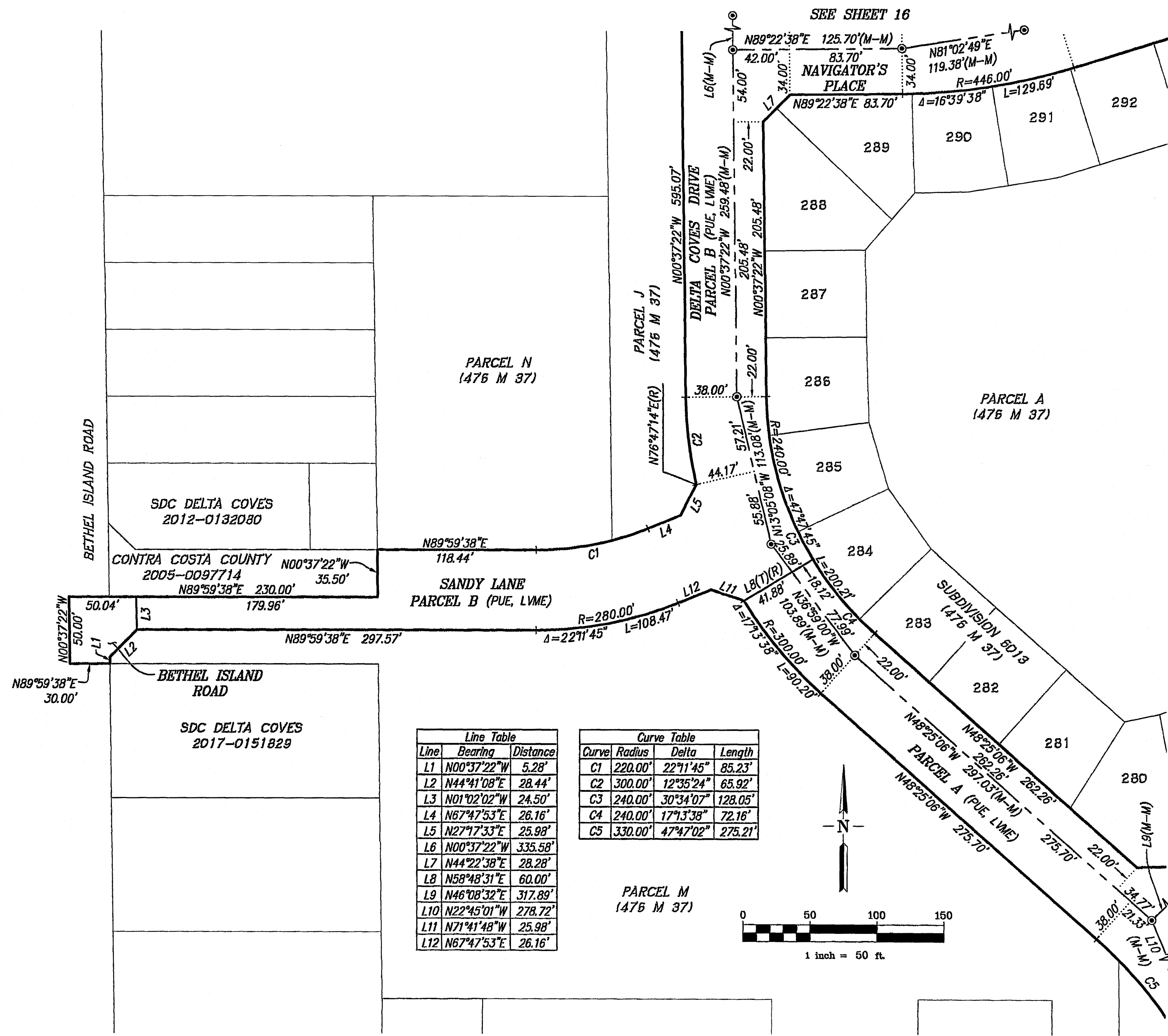

SEE SHEET 16

NOTE:

1. ALL MONUMENT TIE LINES ARE AT RIGHT ANGLES TO THE MONUMENT LINE UNLESS OTHERWISE NOTED.

BASIS OF BEARINGS

THE BEARING N89°39'55"E OF THE LINE BETWEEN MONUMENTS AT THE EAST 1/4 CORNER AND THE WEST 1/4 CORNER OF SECTION 15, TOWNSHIP 2 NORTH, RANGE 3 EAST, MOUNT DIABLO BASE AND MERIDIAN, AS SHOWN ON PARCEL MAP MS 124-69 FILED SEPTEMBER 16, 1971 IN BOOK 18 OF PARCEL MAPS AT PAGES 23-24, OFFICIAL RECORDS OF CONTRA COSTA COUNTY.

LEGEND

- SUBDIVISION BOUNDARY
- LOT LINE
- - - - - EXISTING EASEMENT AS NOTED
- - - - - NEW EASEMENT AS NOTED
- MONUMENT LINE
- MONUMENT TIE LINE
- EXISTING LOT LINE

- FOUND POINT AS NOTED
- ⊙ FOUND EXISTING STREET MONUMENT (1), STAMPED RCE 25281

- LVME PUBLIC LEVEE MAINTENANCE EASEMENT
- PUE PUBLIC UTILITY EASEMENT
- PSLE PRIVATE SLOPE EASEMENT
- SDE STORM DRAIN EASEMENT
- WLE WATER LINE EASEMENT
- ⊕ CENTERLINE
- EX EXISTING
- (M-M) MONUMENT TO MONUMENT
- (R) RADIAL BEARING
- (T) TOTAL
- FND FOUND
- IP IRON PIPE
- R/W RIGHT OF WAY
- STD STANDARD
- CCC COUNTY OF CONTRA COSTA
- (DATA)(1) RECORD DATA & REFERENCE
- SFNF SEARCHED FOR NOTHING FOUND
- NRF NO RECORD FOUND

**SUBDIVISION 9582
DELTA COVES STREETS**

LANDS DESIGNATED AS SANDY LANE, DELTA COVES DRIVE, STONE ROAD, SHORELINE PLACE, SLOUGH PLACE, SEA DRIFT DRIVE, SEA MEADOW COURT, POINT PLACE, CHANNEL PLACE, ISLE PLACE, HALCYON PLACE, NAVIGATOR'S PLACE, WATERSIDE PLACE, GATEWAY ROAD, EDGEWATER DRIVE, EDGEWATER COURT, SEA GATE PLACE, SEAWARD COURT, GREY WHALE PLACE, WINDSWEEP ROAD, AND WEST WIND PLACE AS DESIGNATED ON SUBDIVISION 6013 (476 M 370), CONTRA COSTA COUNTY RECORDS

CONTRA COSTA COUNTY
CALIFORNIA
RUGGERI-JENSEN-AZAR
CIVIL ENGINEERS, PLANNERS, SURVEYORS
PLEASANTON, CALIFORNIA
SEPTEMBER 2021
SCALE: 1" = 50'

JOB NO. 131019

SHEET 14 OF 25 SHEETS

Line	Bearing	Distance
L1	N00°37'22"W	5.28'
L2	N44°41'08"E	28.44'
L3	N01°02'02"W	24.50'
L4	N67°47'53"E	26.16'
L5	N27°17'33"E	25.98'
L6	N00°37'22"W	335.58'
L7	N44°22'38"E	28.28'
L8	N58°48'31"E	60.00'
L9	N46°08'32"E	317.89'
L10	N22°45'01"W	278.72'
L11	N71°41'48"W	25.98'
L12	N67°47'53"E	26.16'

Curve	Radius	Delta	Length
C1	220.00'	22°11'45"	85.23'
C2	300.00'	12°35'24"	65.92'
C3	240.00'	30°34'07"	128.05'
C4	240.00'	17°13'38"	72.16'
C5	330.00'	47°47'02"	275.21'

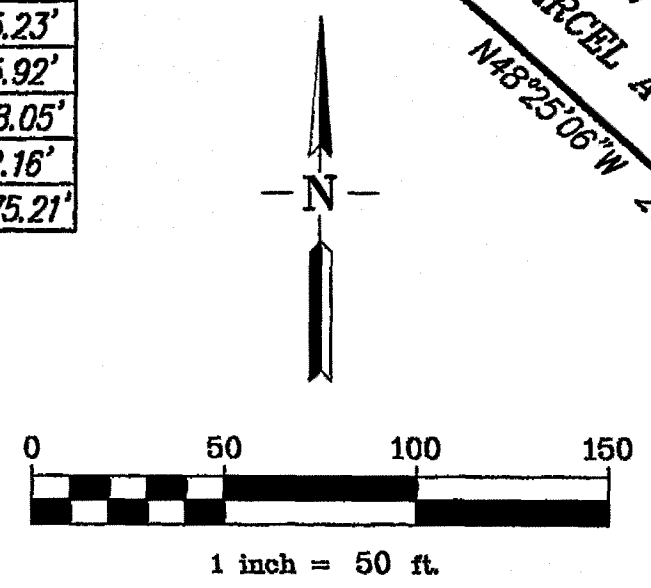

PARCEL A
(476 M 37)

NOTE:

1. ALL MONUMENT TIE LINES ARE AT RIGHT ANGLES TO THE MONUMENT LINE UNLESS OTHERWISE NOTED.

BASIS OF BEARINGS

THE BEARING N89°39'55"E OF THE LINE BETWEEN MONUMENTS AT THE EAST 1/4 CORNER AND THE WEST 1/4 CORNER OF SECTION 15, TOWNSHIP 2 NORTH, RANGE 3 EAST, MOUNT DIABLO BASE AND MERIDIAN, AS SHOWN ON PARCEL MAP MS 124-69 FILED SEPTEMBER 16, 1971 IN BOOK 18 OF PARCEL MAPS AT PAGES 23-24, OFFICIAL RECORDS OF CONTRA COSTA COUNTY.

LEGEND

- SUBDIVISION BOUNDARY
 - LOT LINE
 - - - - - EXISTING EASEMENT AS NOTED
 - - - - - NEW EASEMENT AS NOTED
 - MONUMENT LINE
 - MONUMENT TIE LINE
 - EXISTING LOT LINE
- FOUND POINT AS NOTED
 - ⊙ FOUND EXISTING STREET MONUMENT (1), STAMPED RCE 25281
- LVME PUBLIC LEVEE MAINTENANCE EASEMENT
 - PUE PUBLIC UTILITY EASEMENT
 - PSLE PRIVATE SLOPE EASEMENT
 - SDE STORM DRAIN EASEMENT
 - WLE WATER LINE EASEMENT
 - ⊕ CENTERLINE
 - EX. EXISTING
 - (M-M) MONUMENT TO MONUMENT
 - (R) RADIAL BEARING
 - (T) TOTAL
 - FND FOUND
 - IP IRON PIPE
 - R/W RIGHT OF WAY
 - STD STANDARD
 - CCC COUNTY OF CONTRA COSTA
 - (DATA)(1) RECORD DATA & REFERENCE
 - SFNF SEARCHED FOR NOTHING FOUND
 - NRF NO RECORD FOUND

**SUBDIVISION 9582
DELTA COVES STREETS**

LANDS DESIGNATED AS SANDY LANE, DELTA COVES DRIVE, STONE ROAD, SHORELINE PLACE, SLOUGH PLACE, SEA DRIFT DRIVE, SEA MEADOW COURT, POINT PLACE, CHANNEL PLACE, ISLE PLACE, HALCYON PLACE, NAVIGATOR'S PLACE, WATERSIDE PLACE, GATEWAY ROAD, EDGEWATER DRIVE, EDGEWATER COURT, SEA GATE PLACE, SEAWARD COURT, GREY WHALE PLACE, WINDSWEEP ROAD, AND WEST WIND PLACE AS DESIGNATED ON SUBDIVISION 6013 (476 M 370), CONTRA COSTA COUNTY RECORDS

CONTRA COSTA COUNTY
CALIFORNIA

RUGGERI-JENSEN-AZAR
CIVIL ENGINEERS, PLANNERS, SURVEYORS
PLEASANTON, CALIFORNIA
SEPTEMBER 2021
SCALE: 1" = 50'

C:\L2020\131019\SUBDIVISION 9582\DELTA COVES STREETS\DELTA COVES STREETS.DWG 11/02/20 11:02:40 AM ALAN MILLER

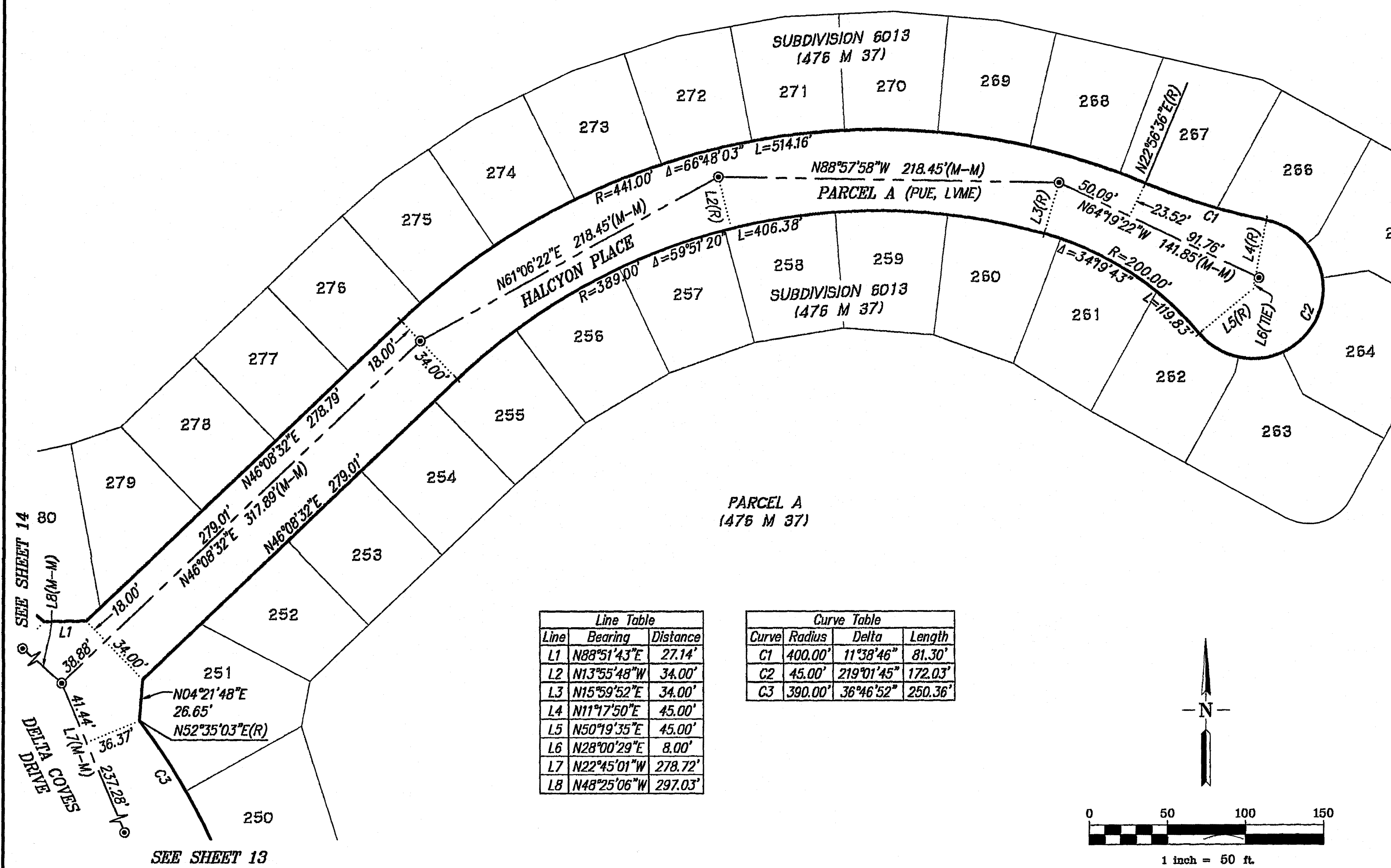

Line	Bearing	Distance
L1	N88°51'43"E	27.14'
L2	N13°55'48"W	34.00'
L3	N15°59'52"E	34.00'
L4	N11°17'50"E	45.00'
L5	N50°19'35"E	45.00'
L6	N28°00'29"E	8.00'
L7	N22°45'01"W	278.72'
L8	N48°25'06"W	297.03'

Curve	Radius	Delta	Length
C1	400.00'	11°38'46"	81.30'
C2	45.00'	219°01'45"	172.03'
C3	390.00'	36°46'52"	250.36'

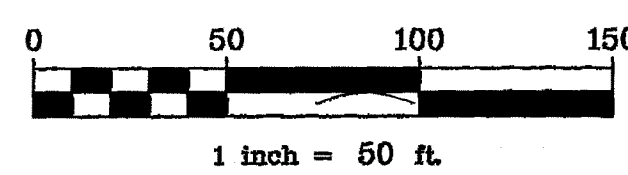

SEE SHEET 13

SEE SHEET 14

GATEWAY ROAD

GATEWAY ROAD

NOTE:

1. ALL MONUMENT TIE LINES ARE AT RIGHT ANGLES TO THE MONUMENT LINE UNLESS OTHERWISE NOTED.

BASIS OF BEARINGS

THE BEARING N89°39'55"E OF THE LINE BETWEEN MONUMENTS AT THE EAST 1/4 CORNER AND THE WEST 1/4 CORNER OF SECTION 15, TOWNSHIP 2 NORTH, RANGE 3 EAST, MOUNT DIABLO BASE AND MERIDIAN, AS SHOWN ON PARCEL MAP MS 124-69 FILED SEPTEMBER 16, 1971 IN BOOK 18 OF PARCEL MAPS AT PAGES 23-24, OFFICIAL RECORDS OF CONTRA COSTA COUNTY.

LEGEND

- SUBDIVISION BOUNDARY
- LOT LINE
- EXISTING EASEMENT AS NOTED
- NEW EASEMENT AS NOTED
- MONUMENT LINE
- MONUMENT TIE LINE
- EXISTING LOT LINE
- FOUND POINT AS NOTED
- ⊙ FOUND EXISTING STREET MONUMENT (1), STAMPED RCE 25281
- LVME PUBLIC LEVEL MAINTENANCE EASEMENT
- PUE PUBLIC UTILITY EASEMENT
- PSLE PRIVATE SLOPE EASEMENT
- SDE STORM DRAIN EASEMENT
- WLE WATER LINE EASEMENT
- ⊕ CENTERLINE
- EX. EXISTING
- (M-M) MONUMENT TO MONUMENT
- (R) RADIAL BEARING
- (T) TOTAL
- FND FOUND
- IP IRON PIPE
- R/W RIGHT OF WAY
- STD STANDARD
- CCC COUNTY OF CONTRA COSTA
- (DATA)(1) RECORD DATA & REFERENCE
- SFNF SEARCHED FOR NOTHING FOUND
- NR F NO RECORD FOUND

Line Table		
Line	Bearing	Distance
L1	N45°37'22"W	28.28'
L2	N89°22'38"E	83.70'
L3	N10°35'22"W	34.00'
L4	N00°37'22"W	259.48'
L5	N45°28'43"W	38.00'

Curve Table			
Curve	Radius	Delta	Length
C1	400.00'	14°39'02"	102.28'
C2	400.00'	20°14'47"	141.35'

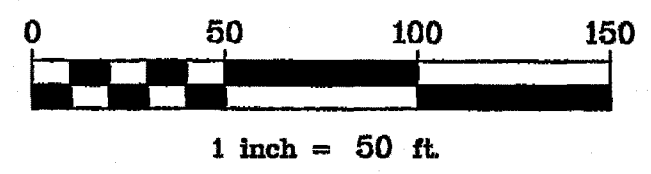
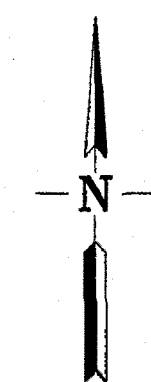

SEE SHEET 17

SEE SHEET 17

**SUBDIVISION 9582
DELTA COVES STREETS**

LANDS DESIGNATED AS SANDY LANE, DELTA COVES DRIVE, STONE ROAD, SHORELINE PLACE, SLOUGH PLACE, SEA DRIFT DRIVE, SEA MEADOW COURT, POINT PLACE, CHANNEL PLACE, ISLE PLACE, HALCYON PLACE, NAVIGATOR'S PLACE, WATERSIDE PLACE, GATEWAY ROAD, EDGEWATER DRIVE, EDGEWATER COURT, SEA GATE PLACE, SEAWARD COURT, GREY WHALE PLACE, WINDSWEEP ROAD, AND WEST WIND PLACE AS DESIGNATED ON SUBDIVISION 6013 (476 M 370), CONTRA COSTA COUNTY RECORDS

CONTRA COSTA COUNTY
CALIFORNIA
RUGGERI-JENSEN-AZAR
CIVIL ENGINEERS, PLANNERS, SURVEYORS
PLEASANTON, CALIFORNIA
SEPTEMBER 2021
SCALE: 1" = 50'

G:\AR\2021\131019\131019-01\131019-01.dwg 10/14/2021 11:04:55 AM ALAN MULLER

PARCEL J
(476 M 37)
(NOT A PART)

PARCEL B (PUE, LVME)

PARCEL A
(476 M 37)

SUBDIVISION 6013
(476 M 37)

PARCEL B (PUE, LVME)

SUBDIVISION 6013
(476 M 37)

NAVIGATOR'S PLACE

DELTA COVES DRIVE

SEE SHEET 14

SEE SHEET 17

GATEWAY ROAD

N89°39'55"E 4856.09'

GATEWAY ROAD

N89°39'55"E 4528.84'

2021.97'

PARCEL J
(476 M 37)
(NOT A PART)

N89°39'55"E 1135.92'

N89°39'55"E 950.30'(M-M)

896.30'

DELTA COVES DRIVE

PARCEL B (PUE, LVME)

N89°39'55"E 896.30'

N89°39'55"E 185.61'(M-M)

22.00'

R=350.00' Δ=31°44'12" L=193.87'

147.61'

R=290.00' Δ=31°44'12" L=160.63'

N89°39'55"E 147.61'

SEE SHEET 16

SEE SHEET 19

330

331

332

333

334

335

336

337

366

367

368

369

SUBDIVISION 6013
(476 M 37)

364
SUBDIVISION 6013
(476 M 37)

PARCEL A
(476 M 37)

Line	Bearing	Distance
L1	N23°32'09"W	45.00'
L2	N09°39'26"E	45.00'
L3	N06°59'42"W	8.00'
L4	N45°20'05"W	28.28'
L5	N44°39'55"E	28.28'
L6	N71°39'52"E	34.00'
L7	N53°39'50"E	34.00'
L8	N45°20'12"W	191.48'

Curve	Radius	Delta	Length
C1	400.00'	14°39'02"	102.28'
C2	45.00'	213°11'35"	167.44'
C3	400.00'	20°14'47"	141.35'

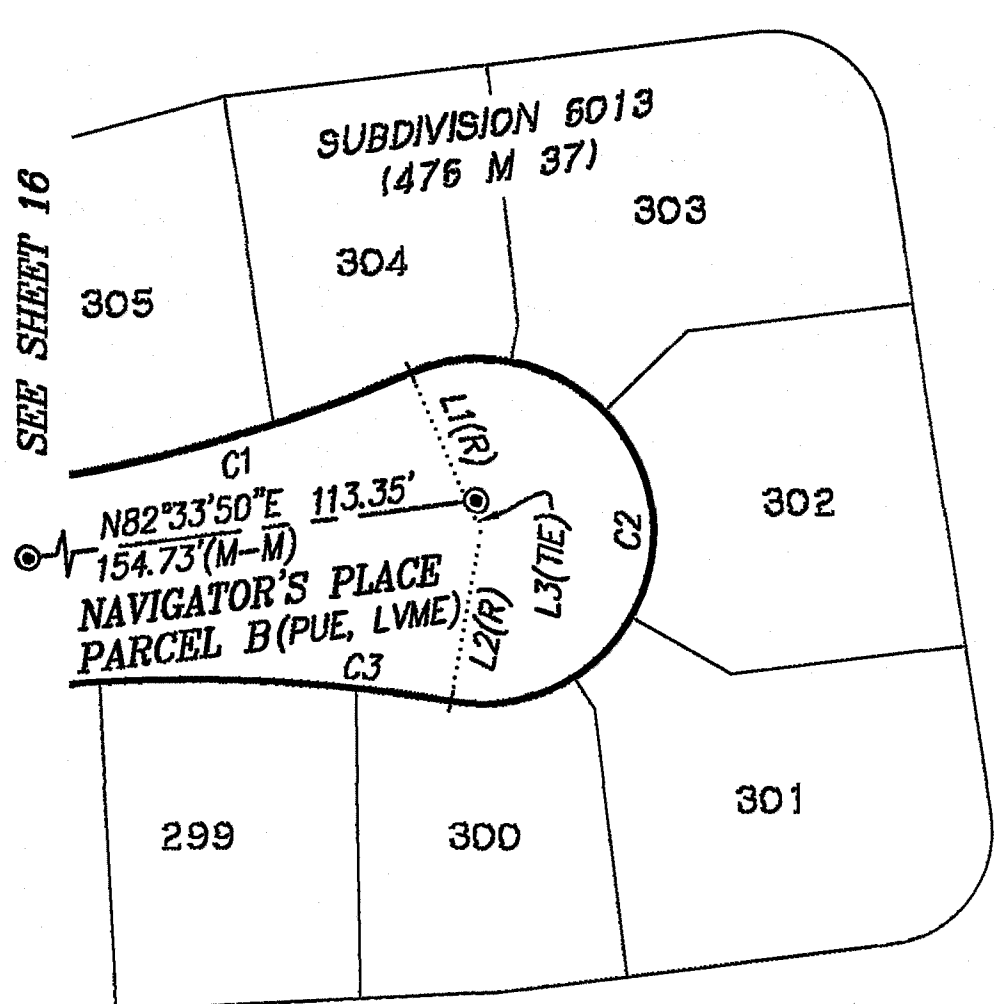

PARCEL A
(476 M 37)

WATERSIDE PLACE

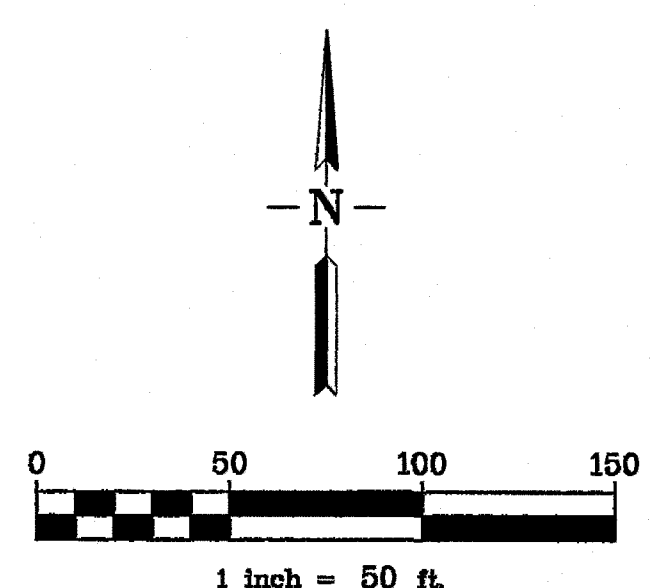

NOTE:

1. ALL MONUMENT TIE LINES ARE AT RIGHT ANGLES TO THE MONUMENT LINE UNLESS OTHERWISE NOTED.

BASIS OF BEARINGS

THE BEARING N89°39'55"E OF THE LINE BETWEEN MONUMENTS AT THE EAST 1/4 CORNER AND THE WEST 1/4 CORNER OF SECTION 15, TOWNSHIP 2 NORTH, RANGE 3 EAST, MOUNT DIABLO BASE AND MERIDIAN, AS SHOWN ON PARCEL MAP MS 124-69 FILED SEPTEMBER 16, 1971 IN BOOK 18 OF PARCEL MAPS AT PAGES 23-24, OFFICIAL RECORDS OF CONTRA COSTA COUNTY.

LEGEND

- SUBDIVISION BOUNDARY
- LOT LINE
- - - - - EXISTING EASEMENT AS NOTED
- - - - - NEW EASEMENT AS NOTED
- MONUMENT LINE
- MONUMENT TIE LINE
- EXISTING LOT LINE
- FOUND POINT AS NOTED
- ⊙ FOUND EXISTING STREET MONUMENT (1), STAMPED RCE 25281
- LVME PUBLIC LEVEE MAINTENANCE EASEMENT
- PUE PUBLIC UTILITY EASEMENT
- PSLE PRIVATE SLOPE EASEMENT
- SDE STORM DRAIN EASEMENT
- WLE WATER LINE EASEMENT
- ⊕ CENTERLINE
- EX. EXISTING
- (M-M) MONUMENT TO MONUMENT
- (R) RADIAL BEARING
- (T) TOTAL
- FND FOUND
- IP IRON PIPE
- R/W RIGHT OF WAY
- STD STANDARD
- CCC COUNTY OF CONTRA COSTA
- (DATA)(1) RECORD DATA & REFERENCE
- SFNF SEARCHED FOR NOTHING FOUND
- NRF NO RECORD FOUND

**SUBDIVISION 9582
DELTA COVES STREETS**

LANDS DESIGNATED AS SANDY LANE, DELTA COVES DRIVE, STONE ROAD, SHORELINE PLACE, SLOUGH PLACE, SEA DRIFT DRIVE, SEA MEADOW COURT, POINT PLACE, CHANNEL PLACE, ISLE PLACE, HALCYON PLACE, NAVIGATOR'S PLACE, WATERSIDE PLACE, GATEWAY ROAD, EDGEWATER DRIVE, EDGEWATER COURT, SEA GATE PLACE, SEAWARD COURT, GREY WHALE PLACE, WINDSWEEP ROAD, AND WEST WIND PLACE AS DESIGNATED ON SUBDIVISION 6013 (476 M 370), CONTRA COSTA COUNTY RECORDS

CONTRA COSTA COUNTY
CALIFORNIA
RUGGERI-JENSEN-AZAR
CIVIL ENGINEERS, PLANNERS, SURVEYORS
PLEASANTON, CALIFORNIA
SEPTEMBER 2021
SCALE: 1" = 50'

C:\JOB2021\131019\SURVEY\CAD FILES\DWG\MPL\131019-FAST2.DWG 10/14/2021 11:05:29 AM ALAN MULLEN

C:\PROJ\131019\DWG\131019-PLANS\131019-PLANS.DWG 10/14/2021 11:05:53 AM ALAN MULLEN

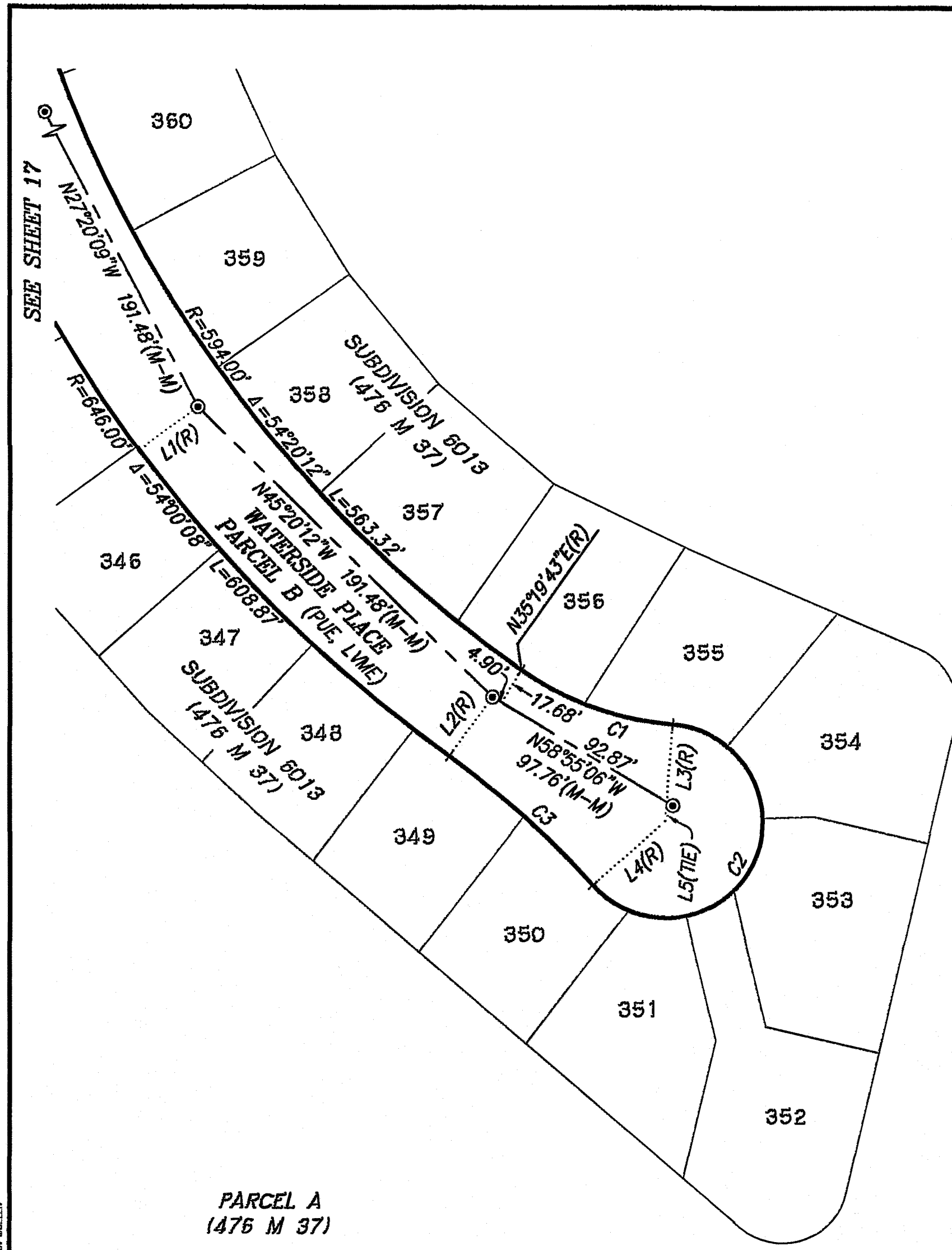

PARCEL A
(476 M 37)

Line Table		
Line	Bearing	Distance
L1	N53°39'50"E	34.00'
L2	N35°39'47"E	34.00'
L3	N04°22'34"E	45.00'
L4	N48°28'51"E	45.00'
L5	N26°30'02"E	8.00'
L6	N67°08'21"E	34.00'
L7	N67°08'21"E	18.00'
L8	N88°09'54"E	34.00'
L9	N75°52'24"E	45.00'
L10	N70°36'45"W	45.00'
L11	N87°18'46"W	8.00'

Curve Table			
Curve	Radius	Delta	Length
C1	140.00'	30°57'08"	75.63'
C2	45.00'	224°06'17"	176.01'
C3	400.00'	12°49'05"	89.49'
C4	474.00'	22°31'34"	186.36'
C5	45.00'	213°30'51"	167.69'

SEE SHEET 19

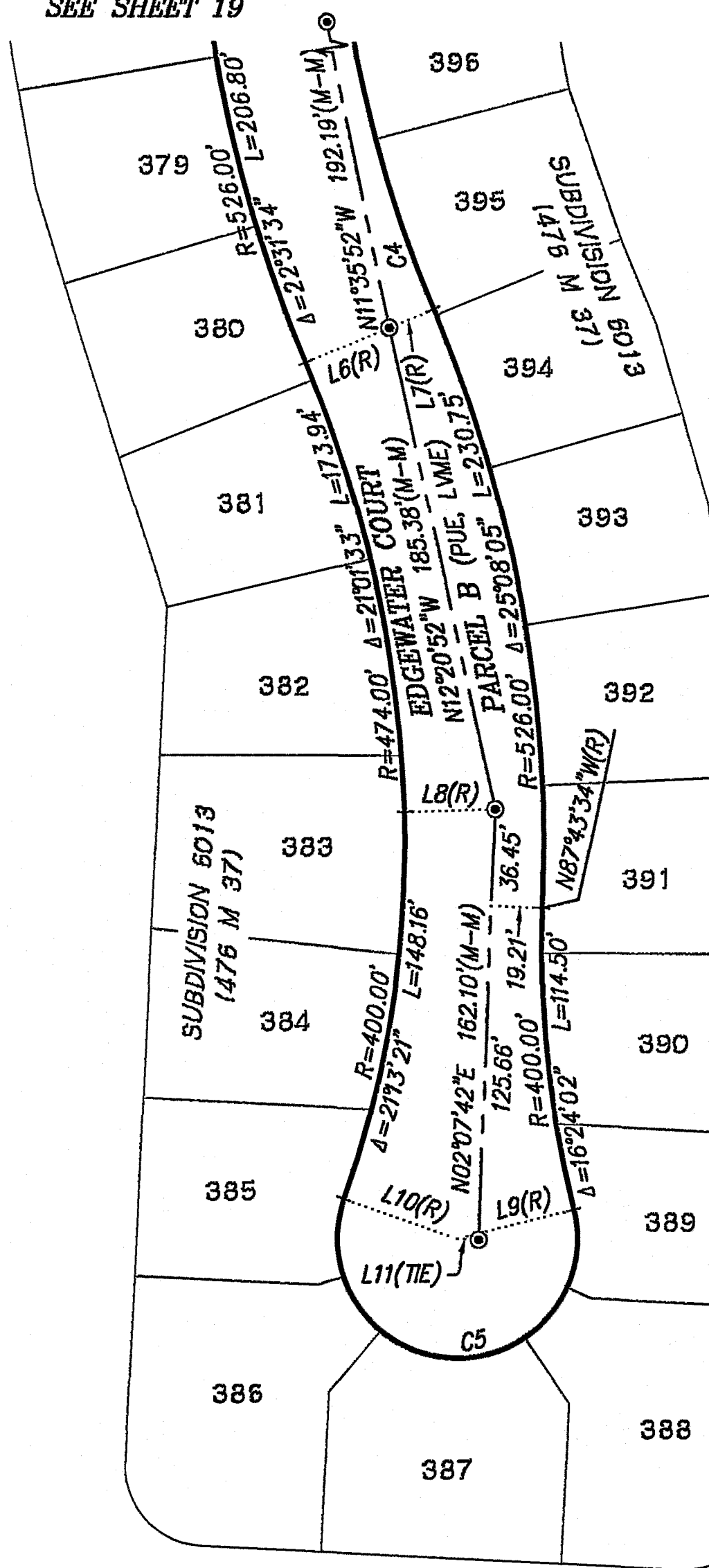

PARCEL A
(476 M 37)

NOTE:

1. ALL MONUMENT TIE LINES ARE AT RIGHT ANGLES TO THE MONUMENT LINE UNLESS OTHERWISE NOTED.

BASIS OF BEARINGS

THE BEARING N89°39'55"E OF THE LINE BETWEEN MONUMENTS AT THE EAST 1/4 CORNER AND THE WEST 1/4 CORNER OF SECTION 15, TOWNSHIP 2 NORTH, RANGE 3 EAST, MOUNT DIABLO BASE AND MERIDIAN, AS SHOWN ON PARCEL MAP MS 124-69 FILED SEPTEMBER 16, 1971 IN BOOK 18 OF PARCEL MAPS AT PAGES 23-24, OFFICIAL RECORDS OF CONTRA COSTA COUNTY.

LEGEND

- SUBDIVISION BOUNDARY
- LOT LINE
- EXISTING EASEMENT AS NOTED
- NEW EASEMENT AS NOTED
- MONUMENT LINE
- MONUMENT TIE LINE
- EXISTING LOT LINE
- FOUND POINT AS NOTED
- FOUND EXISTING STREET MONUMENT (1), STAMPED RCE 25281
- LVME PUBLIC LEVEL MAINTENANCE EASEMENT
- PUE PUBLIC UTILITY EASEMENT
- PSLE PRIVATE SLOPE EASEMENT
- SDE STORM DRAIN EASEMENT
- WLE WATER LINE EASEMENT
- ⊕ CENTERLINE
- ⊕ EX. EXISTING
- (M-M) MONUMENT TO MONUMENT
- (R) RADIAL BEARING
- (T) TOTAL
- FND FOUND
- IP IRON PIPE
- R/W RIGHT OF WAY
- STD STANDARD
- CCC COUNTY OF CONTRA COSTA
- (DATA)(1) RECORD DATA & REFERENCE
- SFNF SEARCHED FOR NOTHING FOUND
- NRF NO RECORD FOUND

**SUBDIVISION 9582
DELTA COVES STREETS**

LANDS DESIGNATED AS SANDY LANE, DELTA COVES DRIVE, STONE ROAD, SHORELINE PLACE, SLOUGH PLACE, SEA DRIFT DRIVE, SEA MEADOW COURT, POINT PLACE, CHANNEL PLACE, ISLE PLACE, HALCYON PLACE, NAVIGATOR'S PLACE, WATERSIDE PLACE, GATEWAY ROAD, EDGEWATER DRIVE, EDGEWATER COURT, SEA GATE PLACE, SEAWARD COURT, GREY WHALE PLACE, WINDSWEEP ROAD, AND WIND PLACE AS DESIGNATED ON SUBDIVISION 6013 (476 M 370), CONTRA COSTA COUNTY RECORDS

CONTRA COSTA COUNTY
CALIFORNIA

RUGGERI-JENSEN-AZAR
CIVIL ENGINEERS, PLANNERS, SURVEYORS
PLEASANTON, CALIFORNIA
SEPTEMBER 2021
SCALE: 1" = 50'

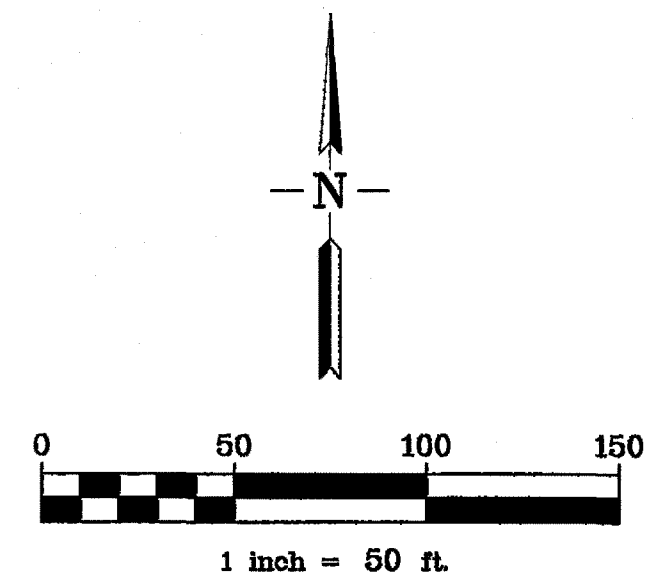

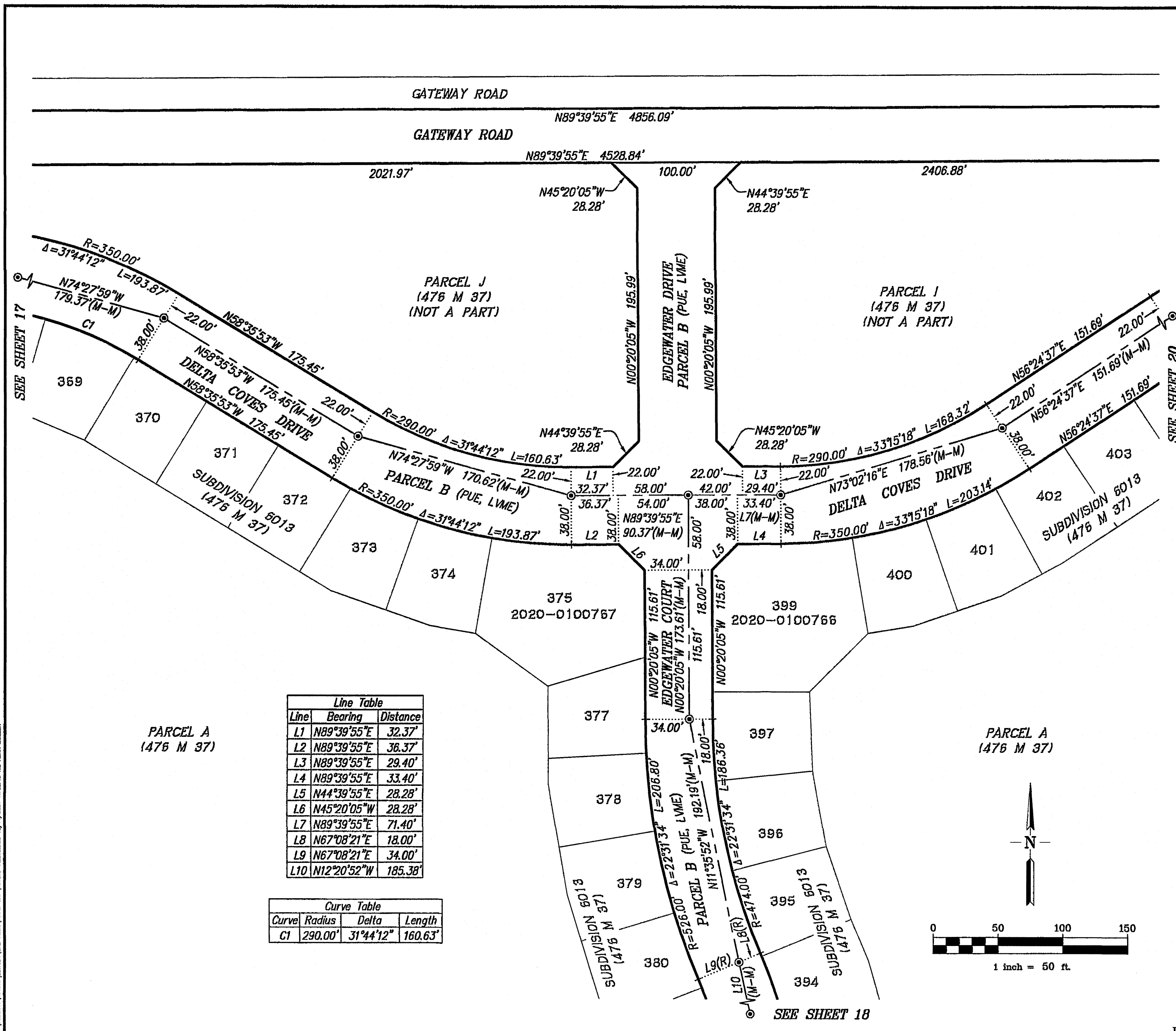

NOTE:

1. ALL MONUMENT TIE LINES ARE AT RIGHT ANGLES TO THE MONUMENT LINE UNLESS OTHERWISE NOTED.

BASIS OF BEARINGS

THE BEARING N89°39'55"E OF THE LINE BETWEEN MONUMENTS AT THE EAST 1/4 CORNER AND THE WEST 1/4 CORNER OF SECTION 15, TOWNSHIP 2 NORTH, RANGE 3 EAST, MOUNT DIABLO BASE AND MERIDIAN, AS SHOWN ON PARCEL MAP MS 124-69 FILED SEPTEMBER 16, 1971 IN BOOK 18 OF PARCEL MAPS AT PAGES 23-24, OFFICIAL RECORDS OF CONTRA COSTA COUNTY.

LEGEND

- SUBDIVISION BOUNDARY
- LOT LINE
- - - - - EXISTING EASEMENT AS NOTED
- - - - - NEW EASEMENT AS NOTED
- MONUMENT LINE
- MONUMENT TIE LINE
- EXISTING LOT LINE
- FOUND POINT AS NOTED
- ⊙ FOUND EXISTING STREET MONUMENT (1), STAMPED RCE 25281
- LVME PUBLIC LEVEE MAINTENANCE EASEMENT
- PUE PUBLIC UTILITY EASEMENT
- PSLE PRIVATE SLOPE EASEMENT
- SDE STORM DRAIN EASEMENT
- WLE WATER LINE EASEMENT
- ⊕ CENTERLINE
- EX. EXISTING
- (M-M) MONUMENT TO MONUMENT
- (R) RADIAL BEARING
- (T) TOTAL
- FND FOUND
- IP IRON PIPE
- R/W RIGHT OF WAY
- STD STANDARD
- CCC COUNTY OF CONTRA COSTA
- (DATA)(1) RECORD DATA & REFERENCE
- SFNF SEARCHED FOR NOTHING FOUND
- NRF NO RECORD FOUND

Line Table		
Line	Bearing	Distance
L1	N89°39'55"E	32.37'
L2	N89°39'55"E	36.37'
L3	N89°39'55"E	29.40'
L4	N89°39'55"E	33.40'
L5	N44°39'55"E	28.28'
L6	N45°20'05"W	28.28'
L7	N89°39'55"E	71.40'
L8	N67°08'21"E	18.00'
L9	N67°08'21"E	34.00'
L10	N12°20'52"W	185.38'

Curve Table			
Curve	Radius	Delta	Length
C1	290.00'	31°44'12"	160.63'

**SUBDIVISION 9582
DELTA COVES STREETS**

LANDS DESIGNATED AS SANDY LANE, DELTA COVES DRIVE, STONE ROAD, SHORELINE PLACE, SLOUGH PLACE, SEA DRIFT DRIVE, SEA MEADOW COURT, POINT PLACE, CHANNEL PLACE, ISLE PLACE, HALCYON PLACE, NAVIGATOR'S PLACE, WATERSIDE PLACE, GATEWAY ROAD, EDGEWATER DRIVE, EDGEWATER COURT, SEA GATE PLACE, SEAWARD COURT, GREY WHALE PLACE, WINDSWEEP ROAD, AND WEST WIND PLACE AS DESIGNATED ON SUBDIVISION 6013 (476 M 370), CONTRA COSTA COUNTY RECORDS

CONTRA COSTA COUNTY
CALIFORNIA
RUGGERI-JENSEN-AZAR
CIVIL ENGINEERS, PLANNERS, SURVEYORS
PLEASANTON, CALIFORNIA
SEPTEMBER 2021
SCALE: 1" = 50'

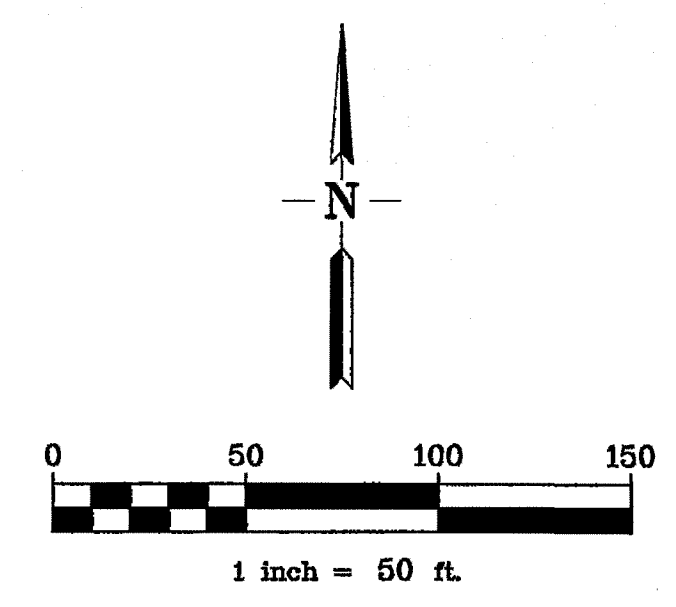

G:\2021\131019\SURVEY\JOB FILES\FINAL MAP\131019-FINISHING 10/14/2021 11:06:19 AM ALAN MILLER

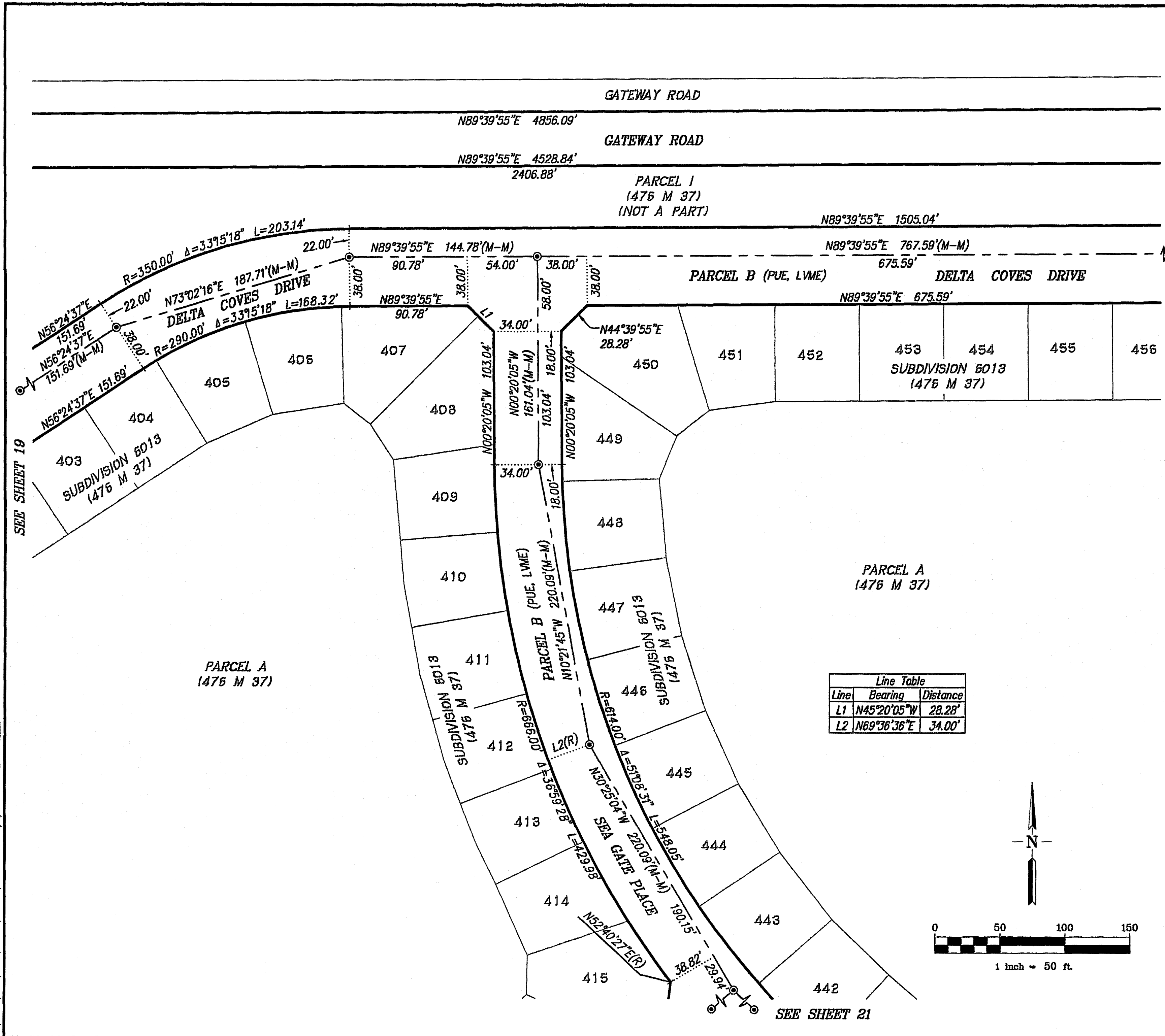

NOTE:
 1. ALL MONUMENT TIE LINES ARE AT RIGHT ANGLES TO THE MONUMENT LINE UNLESS OTHERWISE NOTED.

BASIS OF BEARINGS
 THE BEARING N89°39'55"E OF THE LINE BETWEEN MONUMENTS AT THE EAST 1/4 CORNER AND THE WEST 1/4 CORNER OF SECTION 15, TOWNSHIP 2 NORTH, RANGE 3 EAST, MOUNT DIABLO BASE AND MERIDIAN, AS SHOWN ON PARCEL MAP MS 124-69 FILED SEPTEMBER 16, 1971 IN BOOK 18 OF PARCEL MAPS AT PAGES 23-24, OFFICIAL RECORDS OF CONTRA COSTA COUNTY.

LEGEND

—	SUBDIVISION BOUNDARY
—	LOT LINE
- - -	EXISTING EASEMENT AS NOTED
- - -	NEW EASEMENT AS NOTED
—	MONUMENT LINE
—	MONUMENT TIE LINE
—	EXISTING LOT LINE

- FOUND POINT AS NOTED
- ⊙ FOUND EXISTING STREET MONUMENT (1), STAMPED RCE 25281
- LVME PUBLIC LEVEE MAINTENANCE EASEMENT
- PUE PUBLIC UTILITY EASEMENT
- PSLE PRIVATE SLOPE EASEMENT
- SDE STORM DRAIN EASEMENT
- WLE WATER LINE EASEMENT
- ⊕ CENTERLINE
- EX. EXISTING
- (M-M) MONUMENT TO MONUMENT
- (R) RADIAL BEARING
- (T) TOTAL
- FND FOUND
- IP IRON PIPE
- R/W RIGHT OF WAY
- STD STANDARD
- CCC COUNTY OF CONTRA COSTA
- (DATA)(1) RECORD DATA & REFERENCE
- SFNF SEARCHED FOR NOTHING FOUND
- NRF NO RECORD FOUND

Line Table

Line	Bearing	Distance
L1	N45°20'05"W	28.28'
L2	N69°36'36"E	34.00'

**SUBDIVISION 9582
 DELTA COVES STREETS**

LANDS DESIGNATED AS SANDY LANE, DELTA COVES DRIVE, STONE ROAD, SHORELINE PLACE, SLOUGH PLACE, SEA DRIFT DRIVE, SEA MEADOW COURT, POINT PLACE, CHANNEL PLACE, ISLE PLACE, HALCYON PLACE, NAVIGATOR'S PLACE, WATERSIDE PLACE, GATEWAY ROAD, EDGEWATER DRIVE, EDGEWATER COURT, SEA GATE PLACE, SEAWARD COURT, GREY WHALE PLACE, WINDSWEEP ROAD, AND WEST WIND PLACE AS DESIGNATED ON SUBDIVISION 6013 (476 M 370), CONTRA COSTA COUNTY RECORDS

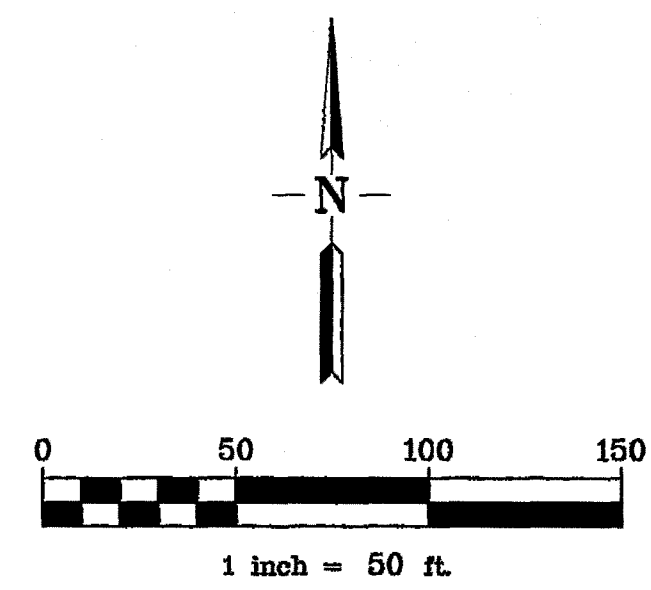

C:\L2021\131019\131019-PLANS\131019-PLANS.DWG 10/14/2021 11:08:54 AM ALAN WILDER

C:\L2021\131019\SURVEY\CAD FILES\FINAL MAP\131019-FINAL.DWG 10/14/2021 11:08:42 AM ALAN MULLEN

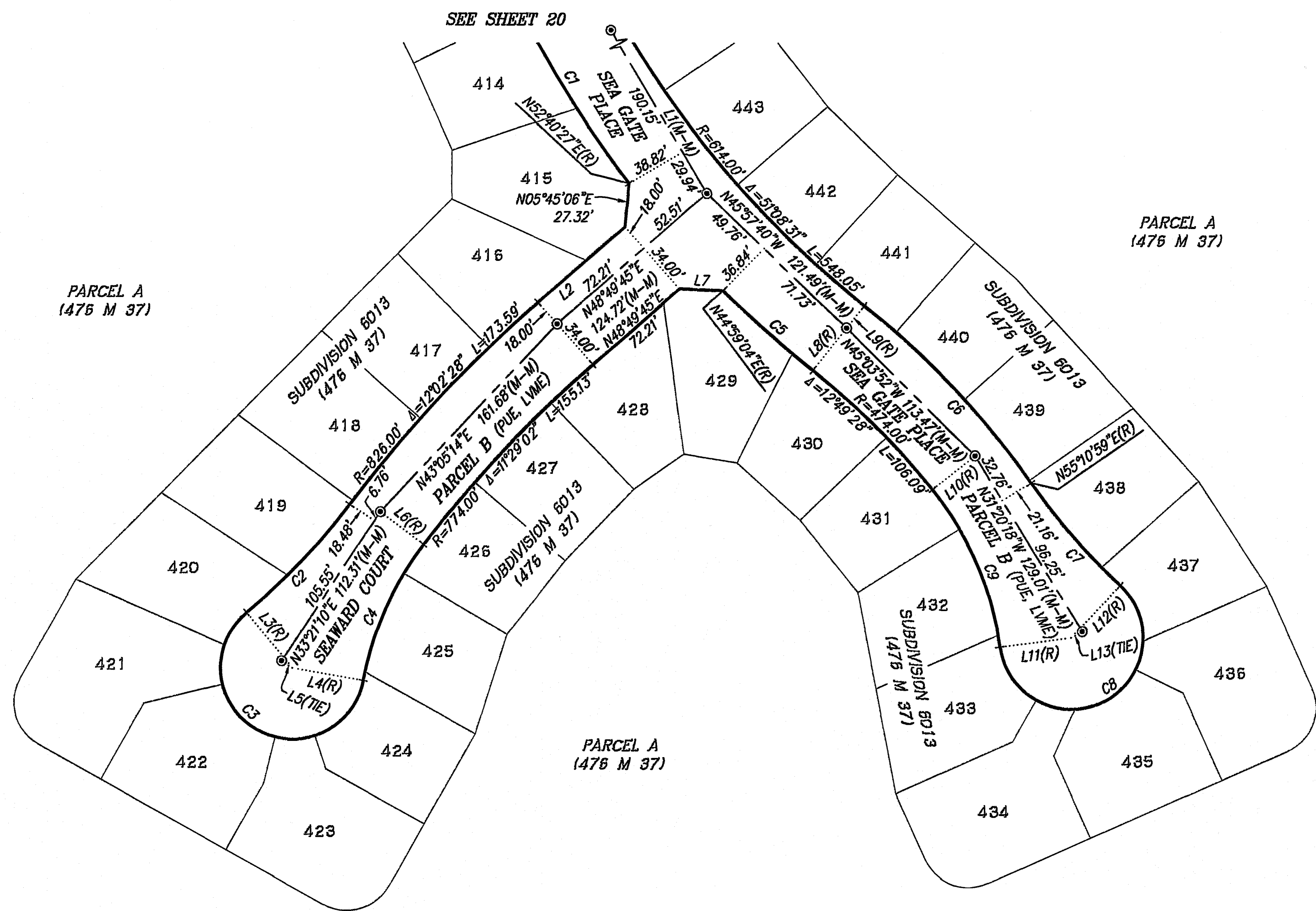

SEE SHEET 20

PARCEL A
(476 M 37)

PARCEL A
(476 M 37)

PARCEL A
(476 M 37)

NOTE:

1. ALL MONUMENT TIE LINES ARE AT RIGHT ANGLES TO THE MONUMENT LINE UNLESS OTHERWISE NOTED.

BASIS OF BEARINGS

THE BEARING N89°39'55"E OF THE LINE BETWEEN MONUMENTS AT THE EAST 1/4 CORNER AND THE WEST 1/4 CORNER OF SECTION 15, TOWNSHIP 2 NORTH, RANGE 3 EAST, MOUNT DIABLO BASE AND MERIDIAN, AS SHOWN ON PARCEL MAP MS 124-69 FILED SEPTEMBER 16, 1971 IN BOOK 18 OF PARCEL MAPS AT PAGES 23-24, OFFICIAL RECORDS OF CONTRA COSTA COUNTY.

LEGEND

- SUBDIVISION BOUNDARY
- LOT LINE
- - - - - EXISTING EASEMENT AS NOTED
- - - - - NEW EASEMENT AS NOTED
- MONUMENT LINE
- MONUMENT TIE LINE
- EXISTING LOT LINE

- FOUND POINT AS NOTED
- ⊙ FOUND EXISTING STREET MONUMENT (1), STAMPED RCE 25281

- LVME PUBLIC LEVEL MAINTENANCE EASEMENT
- PUE PUBLIC UTILITY EASEMENT
- PSLE PRIVATE SLOPE EASEMENT
- SDE STORM DRAIN EASEMENT
- WLE WATER LINE EASEMENT
- Ⓢ CENTERLINE
- EX. EXISTING
- (M-M) MONUMENT TO MONUMENT
- (R) RADIAL BEARING
- (T) TOTAL
- FND FOUND
- IP IRON PIPE
- R/W RIGHT OF WAY
- STD STANDARD
- CCC COUNTY OF CONTRA COSTA
- (DATA)(1) RECORD DATA & REFERENCE
- SFNF SEARCHED FOR NOTHING FOUND
- NRF NO RECORD FOUND

**SUBDIVISION 9582
DELTA COVES STREETS**

LANDS DESIGNATED AS SANDY LANE, DELTA COVES DRIVE, STONE ROAD, SHORELINE PLACE, SLOUGH PLACE, SEA DRIFT DRIVE, SEA MEADOW COURT, POINT PLACE, CHANNEL PLACE, ISLE PLACE, HALCYON PLACE, NAVIGATOR'S PLACE, WATERSIDE PLACE, GATEWAY ROAD, EDGEWATER DRIVE, EDGEWATER COURT, SEA GATE PLACE, SEAWARD COURT, GREY WHALE PLACE, WINDSWEPT ROAD, AND WEST WIND PLACE AS DESIGNATED ON SUBDIVISION 6013 (476 M 37), CONTRA COSTA COUNTY RECORDS

Line	Bearing	Distance
L1	N30°25'04"W	220.09'
L2	N48°49'45"E	72.21'
L3	N39°44'11"W	45.00'
L4	N79°42'07"W	45.00'
L5	N57°10'38"W	8.00'
L6	N52°39'16"W	34.00'
L7	N88°05'36"W	27.32'
L8	N38°31'24"E	34.00'
L9	N38°31'24"E	18.00'
L10	N51°20'52"E	34.00'
L11	N82°30'00"E	45.00'
L12	N42°58'28"E	45.00'
L13	N60°06'16"E	8.00'

Curve	Radius	Delta	Length
C1	666.00'	36°59'28"	429.98'
C2	400.00'	13°28'31"	94.08'
C3	45.00'	219°57'55"	172.76'
C4	200.00'	27°02'50"	94.41'
C5	666.00'	6°27'39"	75.10'
C6	526.00'	16°39'35"	152.94'
C7	400.00'	12°12'31"	85.23'
C8	45.00'	219°31'33"	172.42'
C9	200.00'	31°09'08"	108.74'

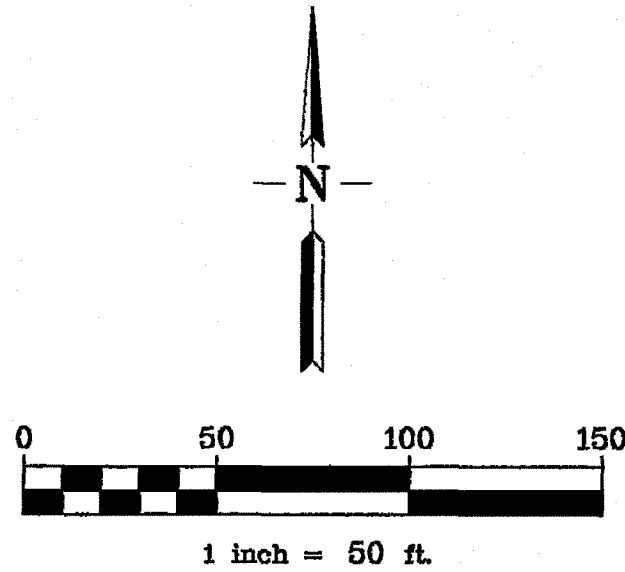

CONTRA COSTA COUNTY
CALIFORNIA

RUGGERI-JENSEN-AZAR
CIVIL ENGINEERS, PLANNERS, SURVEYORS
PLEASANTON, CALIFORNIA
SEPTEMBER 2021
SCALE: 1"=50'

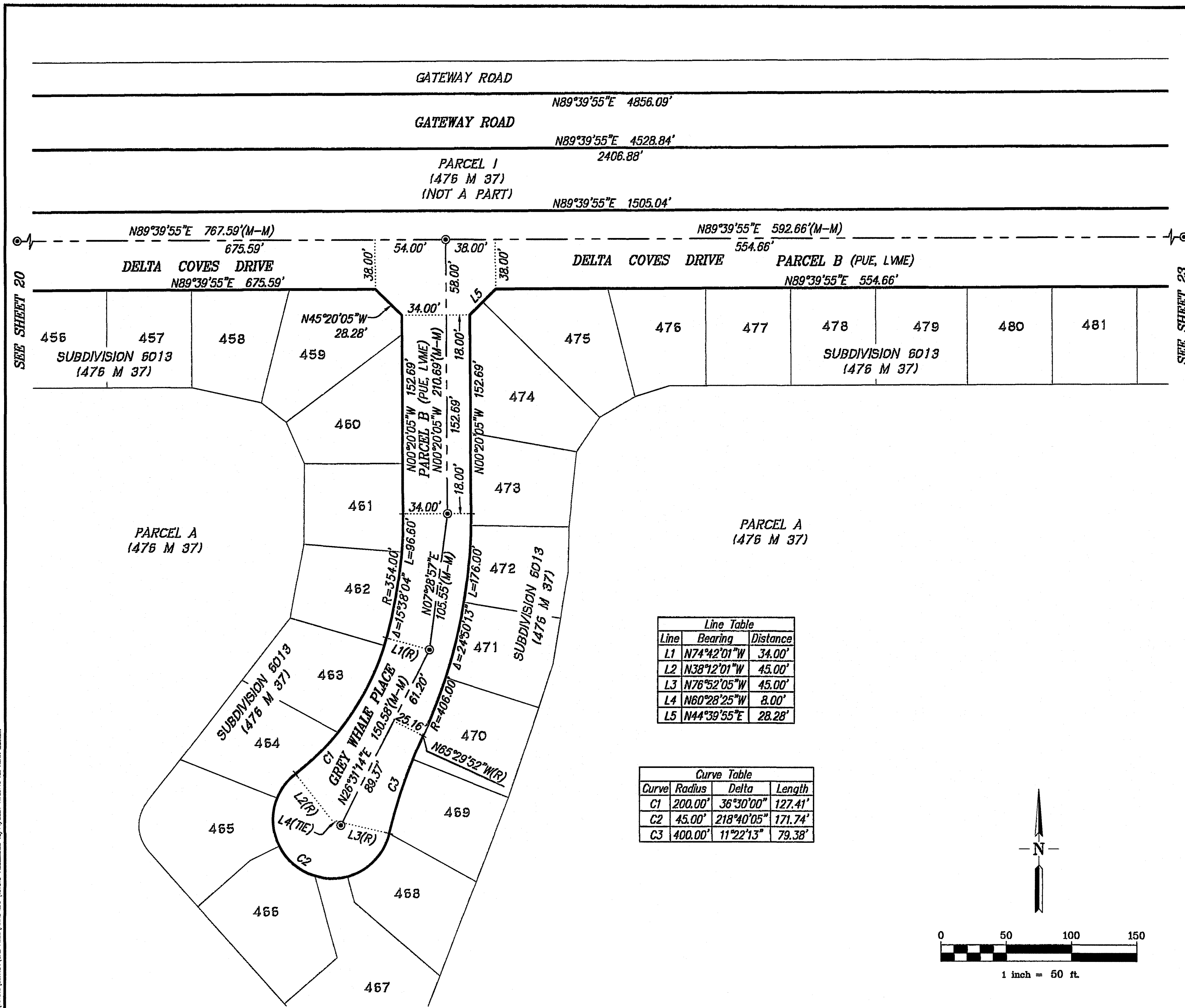

NOTE:
 1. ALL MONUMENT TIE LINES ARE AT RIGHT ANGLES TO THE MONUMENT LINE UNLESS OTHERWISE NOTED.

BASIS OF BEARINGS
 THE BEARING N89°39'55"E OF THE LINE BETWEEN MONUMENTS AT THE EAST 1/4 CORNER AND THE WEST 1/4 CORNER OF SECTION 15, TOWNSHIP 2 NORTH, RANGE 3 EAST, MOUNT DIABLO BASE AND MERIDIAN, AS SHOWN ON PARCEL MAP MS 124-69 FILED SEPTEMBER 16, 1971 IN BOOK 18 OF PARCEL MAPS AT PAGES 23-24, OFFICIAL RECORDS OF CONTRA COSTA COUNTY.

LEGEND

—	SUBDIVISION BOUNDARY
---	LOT LINE
- - - -	EXISTING EASEMENT AS NOTED
- · - · -	NEW EASEMENT AS NOTED
—	MONUMENT LINE
—	MONUMENT TIE LINE
---	EXISTING LOT LINE

- FOUND POINT AS NOTED
- ⊙ FOUND EXISTING STREET MONUMENT (1), STAMPED RCE 25281
- LVME PUBLIC LEVEE MAINTENANCE EASEMENT
- PUE PUBLIC UTILITY EASEMENT
- PSLE PRIVATE SLOPE EASEMENT
- SDE STORM DRAIN EASEMENT
- WLE WATER LINE EASEMENT
- ⊕ CENTERLINE
- EX. EXISTING
- (M-M) MONUMENT TO MONUMENT
- (R) RADIAL BEARING
- (T) TOTAL
- FND FOUND
- IP IRON PIPE
- R/W RIGHT OF WAY
- STD STANDARD
- CCC COUNTY OF CONTRA COSTA
- (DATA)(1) RECORD DATA & REFERENCE
- SFNF SEARCHED FOR NOTHING FOUND
- NRF NO RECORD FOUND

Line Table

Line	Bearing	Distance
L1	N74°42'01"W	34.00'
L2	N38°12'01"W	45.00'
L3	N76°52'05"W	45.00'
L4	N60°28'25"W	8.00'
L5	N44°39'55"E	28.28'

Curve Table

Curve	Radius	Delta	Length
C1	200.00'	36°30'00"	127.41'
C2	45.00'	218°40'05"	171.74'
C3	400.00'	11°22'13"	79.38'

**SUBDIVISION 9582
 DELTA COVES STREETS**

LANDS DESIGNATED AS SANDY LANE, DELTA COVES DRIVE, STONE ROAD, SHORELINE PLACE, SLOUGH PLACE, SEA DRIFT DRIVE, SEA MEADOW COURT, POINT PLACE, CHANNEL PLACE, ISLE PLACE, HALCYON PLACE, NAVIGATOR'S PLACE, WATERSIDE PLACE, GATEWAY ROAD, EDGEWATER DRIVE, EDGEWATER COURT, SEA GATE PLACE, SEAWARD COURT, GREY WHALE PLACE, WINDSWEEP ROAD, AND WEST WIND PLACE AS DESIGNATED ON SUBDIVISION 6013 (476 M 370), CONTRA COSTA COUNTY RECORDS

CONTRA COSTA COUNTY
 CALIFORNIA
 RUGGERI-JENSEN-AZAR
 CIVIL ENGINEERS, PLANNERS, SURVEYORS
 PLEASANTON, CALIFORNIA
 SEPTEMBER 2021
 SCALE: 1" = 50'

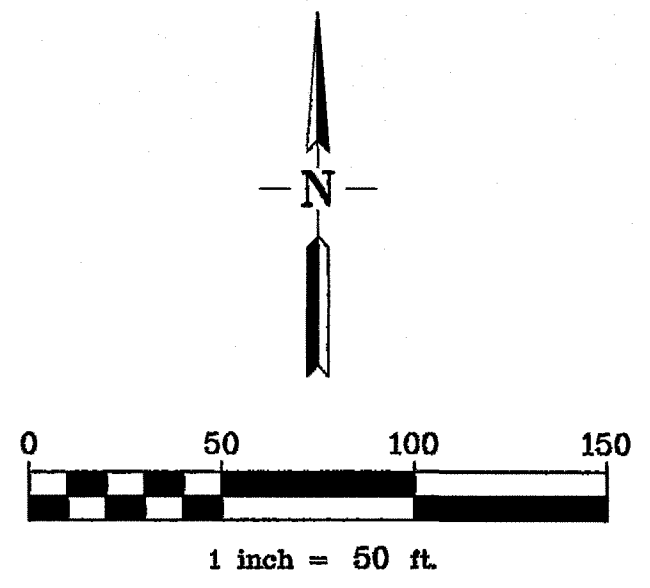

C:\WORK\2021\131019\SURVEY\CAD FILES\FINAL MAP\131019-FMS22.DWG 10/14/2021 11:08:16 AM ALAN MULLEN

C:\L2021\131019\SURVEY\CAD FILES\DWG MAP\131019-MS21.DWG 10/14/2021 11:05:41 AM ALAN MULLER

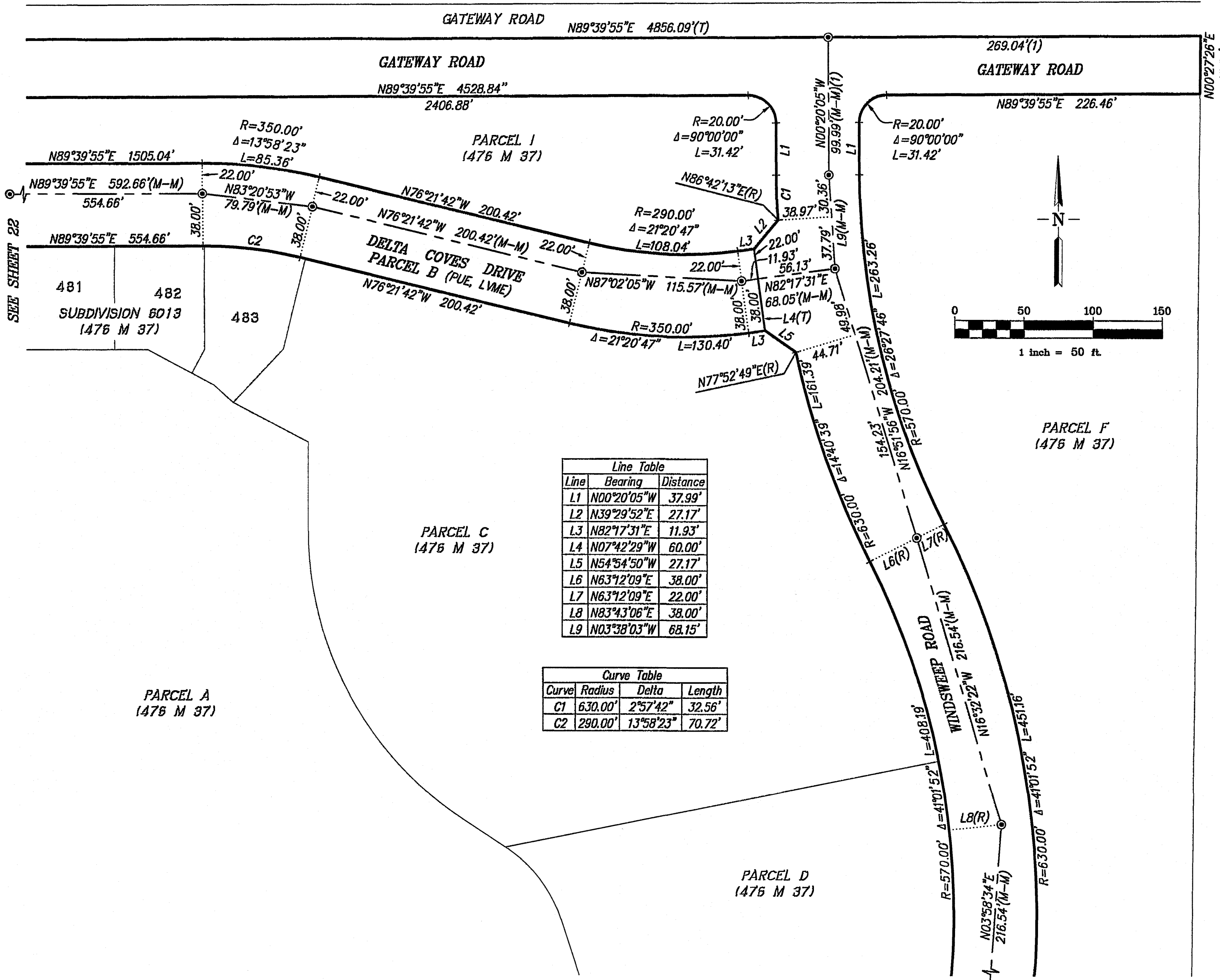

Line Table		
Line	Bearing	Distance
L1	N00°20'05"W	37.99'
L2	N39°29'52"E	27.17'
L3	N82°17'31"E	11.93'
L4	N07°42'29"W	60.00'
L5	N54°54'50"W	27.17'
L6	N63°12'09"E	38.00'
L7	N63°12'09"E	22.00'
L8	N83°43'06"E	38.00'
L9	N03°38'03"W	68.15'

Curve Table			
Curve	Radius	Delta	Length
C1	630.00'	2°57'42"	32.56'
C2	290.00'	13°58'23"	70.72'

NOTE:

1. ALL MONUMENT TIE LINES ARE AT RIGHT ANGLES TO THE MONUMENT LINE UNLESS OTHERWISE NOTED.

BASIS OF BEARINGS

THE BEARING N89°39'55"E OF THE LINE BETWEEN MONUMENTS AT THE EAST 1/4 CORNER AND THE WEST 1/4 CORNER OF SECTION 15, TOWNSHIP 2 NORTH, RANGE 3 EAST, MOUNT DIABLO BASE AND MERIDIAN, AS SHOWN ON PARCEL MAP MS 124-69 FILED SEPTEMBER 16, 1971 IN BOOK 18 OF PARCEL MAPS AT PAGES 23-24, OFFICIAL RECORDS OF CONTRA COSTA COUNTY.

LEGEND

- SUBDIVISION BOUNDARY
- LOT LINE
- EXISTING EASEMENT AS NOTED
- NEW EASEMENT AS NOTED
- MONUMENT LINE
- MONUMENT TIE LINE
- EXISTING LOT LINE
- FOUND POINT AS NOTED
- FOUND EXISTING STREET MONUMENT (1), STAMPED RCE 25281
- LVME PUBLIC LEEVE MAINTENANCE EASEMENT
- PUE PUBLIC UTILITY EASEMENT
- PSLE PRIVATE SLOPE EASEMENT
- SDE STORM DRAIN EASEMENT
- WLE WATER LINE EASEMENT
- ☉ CENTERLINE
- EX EXISTING
- (M-M) MONUMENT TO MONUMENT
- (R) RADIAL BEARING
- (T) TOTAL
- FND FOUND
- IP IRON PIPE
- R/W RIGHT OF WAY
- STD STANDARD
- CCC COUNTY OF CONTRA COSTA
- (DATA)(1) RECORD DATA & REFERENCE
- SFNF SEARCHED FOR NOTHING FOUND
- NRF NO RECORD FOUND

**SUBDIVISION 9582
DELTA COVES STREETS**

LANDS DESIGNATED AS SANDY LANE, DELTA COVES DRIVE, STONE ROAD, SHORELINE PLACE, SLOUGH PLACE, SEA DRIFT DRIVE, SEA MEADOW COURT, POINT PLACE, CHANNEL PLACE, ISLE PLACE, HALCYON PLACE, NAVIGATOR'S PLACE, WATERSIDE PLACE, GATEWAY ROAD, EDGEWATER DRIVE, EDGEWATER COURT, SEA GATE PLACE, SEAWARD COURT, GREY WHALE PLACE, WINDSWEEP ROAD, AND WEST WIND PLACE AS DESIGNATED ON SUBDIVISION 6013 (476 M 370), CONTRA COSTA COUNTY RECORDS

CONTRA COSTA COUNTY
CALIFORNIA
RUGGERI-JENSEN-AZAR
CIVIL ENGINEERS, PLANNERS, SURVEYORS
PLEASANTON, CALIFORNIA
SEPTEMBER 2021
SCALE: 1" = 50'

SEE SHEET 23

Line Table		
Line	Bearing	Distance
L1	N75°45'58"W	38.00'
L2	N75°45'58"W	22.00'
L3	N02°19'23"E	78.71'

Curve Table			
Curve	Radius	Delta	Length
C1	1230.00'	1°06'13"	23.69'

PARCEL A
(476 M 37)

PARCEL D
(476 M 37)

PARCEL F
(476 M 37)

NOTE:

1. ALL MONUMENT TIE LINES ARE AT RIGHT ANGLES TO THE MONUMENT LINE UNLESS OTHERWISE NOTED.

BASIS OF BEARINGS

THE BEARING N89°39'55"E OF THE LINE BETWEEN MONUMENTS AT THE EAST 1/4 CORNER AND THE WEST 1/4 CORNER OF SECTION 15, TOWNSHIP 2 NORTH, RANGE 3 EAST, MOUNT DIABLO BASE AND MERIDIAN, AS SHOWN ON PARCEL MAP MS 124-69 FILED SEPTEMBER 16, 1971 IN BOOK 18 OF PARCEL MAPS AT PAGES 23-24, OFFICIAL RECORDS OF CONTRA COSTA COUNTY.

LEGEND

	SUBDIVISION BOUNDARY
	LOT LINE
	EXISTING EASEMENT AS NOTED
	NEW EASEMENT AS NOTED
	MONUMENT LINE
	MONUMENT TIE LINE
	EXISTING LOT LINE
	FOUND POINT AS NOTED
	FOUND EXISTING STREET MONUMENT (1), STAMPED RCE 25281
LVME	PUBLIC LEVEL MAINTENANCE EASEMENT
PUE	PUBLIC UTILITY EASEMENT
PSLE	PRIVATE SLOPE EASEMENT
SDE	STORM DRAIN EASEMENT
WLE	WATER LINE EASEMENT
CL	CENTERLINE
EX	EXISTING
(M-M)	MONUMENT TO MONUMENT
(R)	RADIAL BEARING
(T)	TOTAL
FND	FOUND
IP	IRON PIPE
R/W	RIGHT OF WAY
STD	STANDARD
CCC	COUNTY OF CONTRA COSTA
(DATA)(1)	RECORD DATA & REFERENCE
SFNF	SEARCHED FOR NOTHING FOUND
NRF	NO RECORD FOUND

**SUBDIVISION 9582
DELTA COVES STREETS**

LANDS DESIGNATED AS SANDY LANE, DELTA COVES DRIVE, STONE ROAD, SHORELINE PLACE, SLOUGH PLACE, SEA DRIFT DRIVE, SEA MEADOW COURT, POINT PLACE, CHANNEL PLACE, ISLE PLACE, HALCYON PLACE, NAVIGATOR'S PLACE, WATERSIDE PLACE, GATEWAY ROAD, EDGEWATER DRIVE, EDGEWATER COURT, SEA GATE PLACE, SEAWARD COURT, GREY WHALE PLACE, WINDSWEEP ROAD, AND WEST WIND PLACE AS DESIGNATED ON SUBDIVISION 6013 (476 M 370), CONTRA COSTA COUNTY RECORDS

CONTRA COSTA COUNTY
CALIFORNIA

RUGGERI-JENSEN-AZAR
CIVIL ENGINEERS, PLANNERS, SURVEYORS
PLEASANTON, CALIFORNIA
SEPTEMBER 2021
SCALE: 1" = 50'

PARCEL B
(476 M 37)

PARCEL A
(476 M 37)

PARCEL E
(476 M 37)

PARCEL G
(476 M 37)

WEST WIND PLACE
PARCEL C (PUE, LVME)

WINDSWEEP ROAD

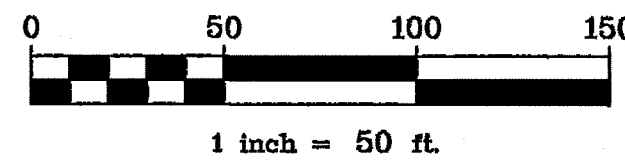
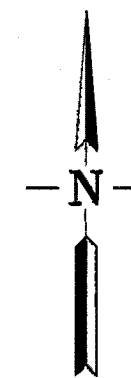

SEE SHEET 25

SEE SHEET 24

PARCEL E
(476 M 37)

PARCEL G
(476 M 37)

PARCEL H
(476 M 37)

PARCEL A
(476 M 37)

Line Table		
Line	Bearing	Distance
L1	N70°44'41"E	38.00'
L2	N51°03'31"E	38.00'
L3	N51°03'31"E	22.00'

Curve Table			
Curve	Radius	Delta	Length
C1	280.00'	3°18'13"	16.14'

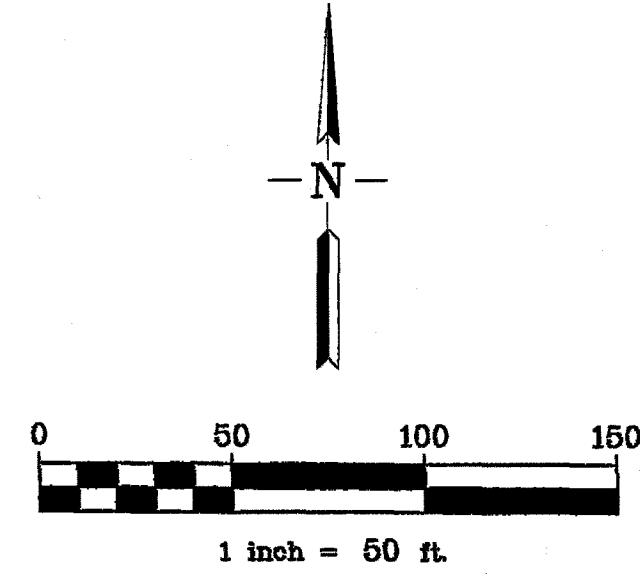

NOTE:

1. ALL MONUMENT TIE LINES ARE AT RIGHT ANGLES TO THE MONUMENT LINE UNLESS OTHERWISE NOTED.

BASIS OF BEARINGS

THE BEARING N89°39'55"E OF THE LINE BETWEEN MONUMENTS AT THE EAST 1/4 CORNER AND THE WEST 1/4 CORNER OF SECTION 15, TOWNSHIP 2 NORTH, RANGE 3 EAST, MOUNT DIABLO BASE AND MERIDIAN, AS SHOWN ON PARCEL MAP MS 124-69 FILED SEPTEMBER 16, 1971 IN BOOK 18 OF PARCEL MAPS AT PAGES 23-24, OFFICIAL RECORDS OF CONTRA COSTA COUNTY.

LEGEND

- SUBDIVISION BOUNDARY
 - LOT LINE
 - EXISTING EASEMENT AS NOTED
 - NEW EASEMENT AS NOTED
 - MONUMENT LINE
 - MONUMENT TIE LINE
 - EXISTING LOT LINE
-
- FOUND POINT AS NOTED
 - ⊙ FOUND EXISTING STREET MONUMENT (1), STAMPED RCE 25281
-
- LVME PUBLIC LEVEE MAINTENANCE EASEMENT
 - PUE PUBLIC UTILITY EASEMENT
 - PSLE PRIVATE SLOPE EASEMENT
 - SDE STORM DRAIN EASEMENT
 - WLE WATER LINE EASEMENT
 - Ⓞ CENTERLINE
 - EX EXISTING
 - (M-M) MONUMENT TO MONUMENT
 - (R) RADIAL BEARING
 - (T) TOTAL
 - FND FOUND
 - IP IRON PIPE
 - R/W RIGHT OF WAY
 - STD STANDARD
 - CCC COUNTY OF CONTRA COSTA
 - (DATA)(1) RECORD DATA & REFERENCE
 - SFNF SEARCHED FOR NOTHING FOUND
 - NRF NO RECORD FOUND

**SUBDIVISION 9582
DELTA COVES STREETS**

LANDS DESIGNATED AS SANDY LANE, DELTA COVES DRIVE, STONE ROAD, SHORELINE PLACE, SLOUGH PLACE, SEA DRIFT DRIVE, SEA MEADOW COURT, POINT PLACE, CHANNEL PLACE, ISLE PLACE, HALCYON PLACE, NAVIGATOR'S PLACE, WATERSIDE PLACE, GATEWAY ROAD, EDGEWATER DRIVE, EDGEWATER COURT, SEA GATE PLACE, SEAWARD COURT, GREY WHALE PLACE, WINDSWEEP ROAD, AND WEST WIND PLACE AS DESIGNATED ON SUBDIVISION 6013 (476 M 370), CONTRA COSTA COUNTY RECORDS

CONTRA COSTA COUNTY
CALIFORNIA

RUGGERI-JENSEN-AZAR
CIVIL ENGINEERS, PLANNERS, SURVEYORS
PLEASANTON, CALIFORNIA
SEPTEMBER 2021
SCALE: 1" = 50'

3/12/22

First American \$ 47.00

Tax Collector's Office
625 Court Street
Finance Building, Room 100
P. O. Box 631
Martinez, California 94553-0063
(925) 957-5280
(925) 957-2898 (FAX)

Contra Costa County

Russell V. Watts
County Treasurer-Tax Collector

Lulis Lopez
Assistant Tax Collector

Danielle Goodbar
Tax Operations Supervisor



Date: 1/26/2022

IF THIS TRACT IS NOT FILED PRIOR TO THE DATE TAXES ARE OPEN FOR COLLECTION (R&T CODE 2608) **THIS LETTER IS VOID.**

This will certify that I have examined the map of the proposed subdivision entitled:

<u>Tract / MS #</u>	<u>City</u>	<u>T.R.A.</u>
9582	Bethel Island	82237

Parcel #: No APNs Streets

and have determined from the official tax records that there are no unpaid County taxes heretofore levied on the property included in the map.

The 2021-2022 tax lien has been paid in full. Our estimate of the 2022-2023 tax lien, which became a Lien on the **1st day of January, 2022** is :

\$0.00

Our estimate for Supplementals taxes is:

\$0.00

This tract is not subject to a 1915 Act Bond.

The amount calculated is **void** 45 days from the date of this letter, unless this letter is accompanied with security approved by the Contra Costa County Tax Collector **Subdivision bond must be presented to the County Tax Collector for review and approval of adequacy of security prior to filing with the Clerk of the Board of Supervisors.**

RUSSEL V. WATTS
Treasurer-Tax Collector

By: 

THE BOARD OF SUPERVISORS OF CONTRA COSTA COUNTY, CALIFORNIA
and for Special Districts, Agencies and Authorities Governed by the Board

Adopted this Resolution on 03/08/2022 by the following vote:

		John Gioia
		Candace Andersen
AYE:	<input type="checkbox"/> 5	Diane Burgis
		Karen Mitchoff
		Federal D. Glover
NO:	<input checked="" type="checkbox"/>	
ABSENT:	<input checked="" type="checkbox"/>	
ABSTAIN:	<input checked="" type="checkbox"/>	
RECUSE:	<input checked="" type="checkbox"/>	



Resolution No. 2022/63

IN THE MATTER OF approving the Final Map for subdivision SD21-09582 (cross-reference DP20-03007), for a project being developed by SDC Delta Coves, LLC, as recommended by the Public Works Director, Bethel Island area. (District III)

WHEREAS, the following documents were presented for board approval this date:

The Final Map of subdivision SD21-09582 (cross-reference DP20-03007), property located in the Bethel Island area, Supervisorial District III, said map having been certified by the proper officials.

Said document was accompanied by:

1. Letter from the County Tax Collector stating that there are no unpaid County taxes heretofore levied on the property included in said map and that the 2021-2022 tax lien has been paid in full and the 2022-2023 tax lien, which became a lien on the first day of January 2022, is estimated to be \$0.00.

NOW, THEREFORE, BE IT RESOLVED:

1. That said subdivision, together with the provisions for its design and improvement, is DETERMINED to be consistent with the County's general and specific plans.
2. That said Final map is APPROVED and this Board does hereby *accept subject to installation and acceptance of improvements* on behalf of the public any of the streets, paths, or easements shown thereon as dedicated to public use.

I hereby certify that this is a true and correct copy of an action taken and entered on the minutes of the Board of Supervisors on the date shown.

ATTESTED: **March 8, 2022**

Monica Nino, County Administrator and Clerk of the Board of Supervisors

Stacey M Boyd
By: Stacey M. Boyd, Deputy

Contact: **Randolf Sanders (925) 313-2111**

cc: Larry Gossett- Engineering Services, Randolf Sanders- Engineering Services, Joshua Laranang- Engineering Services, Ruben Hernandez - DCD, SDC Delta Coves, LLC, First American Title Company, T-01/08/2023



Contra
Costa
County

To: Board of Supervisors
From: Brian M. Balbas, Public Works Director/Chief Engineer
Date: March 8, 2022

Subject: Approve the Stormwater Management Facilities Operation and Maintenance Agreement for development plan permit DP14-03041, Richmond area.

RECOMMENDATION(S):

ADOPT Resolution No. 2022/67 approving the Stormwater Management Facilities Operation and Maintenance Agreement for development plan permit DP14-03041, for a project being developed by IPT Richmond DC III LLC, as recommended by the Public Works Director, Richmond area. (District I)

FISCAL IMPACT:

No fiscal impact.

BACKGROUND:

The Stormwater Management Facilities Operation and Maintenance Agreement is required by Condition of Approval No. 70.

CONSEQUENCE OF NEGATIVE ACTION:

The agreement will not be recorded and the Contra Costa County may not be in full compliance with its National Pollutant Discharge Elimination System (NPDES) permit and Stormwater Management Discharge Control Ordinance.

APPROVE

OTHER

RECOMMENDATION OF CNTY ADMINISTRATOR

RECOMMENDATION OF BOARD COMMITTEE

Action of Board On: **03/08/2022** APPROVED AS RECOMMENDED OTHER

Clerks Notes:

VOTE OF SUPERVISORS

AYE: John Gioia, District I Supervisor
Candace Andersen, District II Supervisor
Diane Burgis, District III Supervisor
Karen Mitchoff, District IV Supervisor
Federal D. Glover, District V Supervisor

I hereby certify that this is a true and correct copy of an action taken and entered on the minutes of the Board of Supervisors on the date shown.

ATTESTED: March 8, 2022
Monica Nino, County Administrator and Clerk of the Board of Supervisors

Contact: Randolph Sanders (925) 313-2111

By: Stacey M. Boyd, Deputy

AGENDA ATTACHMENTS

Resolution No. 2022/67

Stormwater Management Facilities Operation & Maintenance Agreement and Right of Entry

MINUTES ATTACHMENTS

Signed: Resolution No. 2022/67

Recorded at the request of: Clerk of the Board

Return To: Public Works Dept- Simone Saleh

**THE BOARD OF SUPERVISORS OF CONTRA COSTA COUNTY, CALIFORNIA
and for Special Districts, Agencies and Authorities Governed by the Board**

Adopted this Resolution on 03/08/2022 by the following vote:

AYE: John Gioia, District I Supervisor Candace Andersen, District II Supervisor Diane Burgis, District III Supervisor Karen Mitchoff, District IV Supervisor Federal D. Glover, District V Supervisor

NO:

ABSENT:

ABSTAIN:

RECUSE:

Resolution No. 2022/67

IN THE MATTER OF approving the Stormwater Management Facilities Operation and Maintenance Agreement for development plan permit DP14-03041 (APNs 408-180-012 and 408-180-013), Richmond area. (District I)

WHEREAS the Public Works Director has recommended that he be authorized to execute the Stormwater Management Facilities Operation and Maintenance Agreement with IPT Richmond DC III LLC, as required by the Conditions of Approval for development plan permit DP14-03041. This agreement would ensure the operation and maintenance of the stormwater facilities in accordance with the approved Stormwater Control Plan and approved Operation and Maintenance Plan for development plan permit DP14-03041, which is located at 500 Pittsburg Avenue in the Richmond area.

NOW, THEREFORE, BE IT RESOLVED that the recommendation of the Public Works Director is APPROVED.

I hereby certify that this is a true and correct copy of an action taken and entered on the minutes of the Board of Supervisors on the date shown.

ATTESTED: March 8, 2022

Monica Nino, County Administrator and Clerk of the Board of Supervisors

Contact: Randolph Sanders (925) 313-2111

By: Stacey M. Boyd, Deputy

cc: Larry Gossett- Engineering Services, Randolph Sanders- Engineering Services, Ronald Lai, Engineering Services, Michelle Mancuso- Watershed Program, Flood Control, John Steere, Watershed Program, Flood Control, Catherine Windham, Flood Control, Renee Hutchins - Records, Karen Piona- Records, Ruben Hernandez - DCD, IPT Richmond DC III LLC

**Recording Requested By:
COUNTY OF CONTRA COSTA**

**When Recorded, Return To:
COUNTY OF CONTRA COSTA
Contra Costa County Public Works Department
Attn: County Watershed Program
255 Glacier Drive
Martinez, CA 94553**

SPACE ABOVE THIS LINE FOR RECORDER'S USE ONLY

Document Title

COUNTY OF CONTRA COSTA

**COVENANT RUNNING WITH THE LAND,
STORMWATER MANAGEMENT FACILITIES OPERATION
AND MAINTENANCE AGREEMENT, AND RIGHT OF ENTRY**

PROJECT: DP14-3041

PROPERTY OWNER(S): IPT Richmond DC III LLC

ASSESSOR'S PARCEL NUMBER(S): 408-180-012 and 408-180-013

**COVENANT RUNNING WITH THE LAND,
STORMWATER MANAGEMENT FACILITIES
OPERATION AND MAINTENANCE AGREEMENT,
AND RIGHT OF ENTRY**

This Covenant Running with the Land, Stormwater Management Facilities Operation and Maintenance Agreement, and Right of Entry ("Agreement") is made and entered into this _____ day of _____, 20_____, by and between IPT Richmond DC III LLC and the County of Contra Costa, a political subdivision of the State of California.

DEFINITIONS

The following terms used in this Agreement have the meanings specified below:

County: The term "**County**" means the County of Contra Costa and its authorized officers, agents, and employees.

County Engineer: The term "**County Engineer**" means the Public Works Director for the County or his/her designee.

Maintain: The terms "**maintain**," "**maintained**," or "**maintenance**" mean taking all actions reasonably necessary to keep the Stormwater Facilities in first-class operation, condition, and repair, as described in the Stormwater Control Plan and the Operation and Maintenance Plan, which actions include but are not limited to annual inspection and reporting, painting, cleaning, refinishing, repairing, replacing, and reconstructing the Stormwater Facilities, the payment of any applicable County fees, and in the case of landscaping, plant replacement, mulch replacement, irrigating, trimming, mowing, and fertilizing the landscaping.

NPDES Permit: The term "**NPDES Permit**" means the National Pollutant Discharge Elimination System (NPDES) Permit No. CAS612008 issued to the County and other co-permittees by the San Francisco Regional Water Quality Control Board, as amended, and as may be superseded by subsequent NPDES permits that are issued from time to time.

Operation and Maintenance Plan: The term "**Operation and Maintenance Plan**" means the Stormwater Control Operation and Maintenance Plan for the Property prepared by Kier & Wright Civil Engineers and Surveyors, Inc., and deemed consistent with the Ordinance by the County, which may only be modified when, upon written application for such changes, the County Engineer, in his/her sole discretion, provides written consent to such changes. The Operation and Maintenance Plan and any approved changes are on file at the County Public Works Department.

Ordinance: The term "**Ordinance**" means Division 1014 of Title 10 of the Contra Costa County Code (Stormwater Management and Discharge Control), as may be amended from time to time.

Project: The term "**Project**" means DP14-3041, which is being developed on the Property by the Property Owner.

Property: The term "**Property**" means that real property described in Exhibit A attached to this Agreement.

Property Owner: The terms "**Property Owner**" and "**Property Owners**" mean IPT Richmond DC III LLC, and all heirs, successors, executors, administrators, and assigns of any interest in the Property, it being the intent of the parties that the obligations under this Agreement, as provided in Civil Code Section 1468, run with the Property.

Stormwater Control Plan: The term "**Stormwater Control Plan**" means the Stormwater Control Plan prepared by Kier & Wright Civil Engineers and Surveyors, Inc., and deemed consistent with the Ordinance by the County, which may only be modified when, upon written application for such changes, the County Engineer, in his/her sole discretion, provides written consent to such changes. The Stormwater Control Plan and any approved changes are on file at the County Public Works Department.

Stormwater Facilities: The term "**Stormwater Facilities**" means the permanent stormwater management facilities and appurtenant design features located and constructed on the Property, as described in the Stormwater Control Plan and/or the Operation and Maintenance Plan.

RECITALS

This Agreement is made and entered into with reference to the following facts:

- A. The Property Owner is the owner of the Property and intends to develop the Property with impervious surfaces.
- B. The County is the owner of Richmond Parkway and Pittsburg Avenue and associated storm drains that are in the vicinity of the Property, and the County is required to ensure that stormwater runoff from the Property meets the requirements of the NPDES Permit.
- C. To meet its obligations under the NPDES Permit, the County has required the Property Owner to construct the Stormwater Facilities.
- D. To meet its obligations under the NPDES Permit, the County has approved the Property Owner's Operation and Maintenance Plan and the Stormwater Control Plan for the Stormwater Facilities.
- E. To meet the County's obligations under the NPDES Permit, the County's Ordinance requires proper operation and maintenance in perpetuity of the Stormwater Facilities constructed on the Property.
- F. The Operation and Maintenance Plan and/or the Stormwater Control Plan include an annual inspection and reporting requirement and a continuing maintenance requirement for the Stormwater Facilities constructed on the Property.

AGREEMENT

NOW, THEREFORE, in consideration of the above premises, the sufficiency of which is acknowledged, the mutual covenants contained in this Agreement, and the following terms and conditions, the County and the Property Owner agree as follows:

SECTION 1

Responsibility for Operation and Maintenance: The Property Owner represents and warrants that the Stormwater Facilities have been designed and installed in strict accordance with the Stormwater Control Plan, the Operation and Maintenance Plan, and the Ordinance. No portion of the Stormwater Facilities may be altered in any manner that is inconsistent with the Stormwater Control Plan or the Operation and Maintenance Plan without the prior, written consent of the County Engineer. The Property Owner shall continuously maintain the Stormwater Facilities in first-class operating condition, in strict accordance with the Stormwater Control Plan, the Operation and Maintenance Plan, and the Ordinance, and in compliance with all applicable federal, state, and local laws and regulations, as they may be amended from time to time.

The Property Owner shall engage a licensed landscape contractor or other licensed professional acceptable to the County Engineer to undertake the following maintenance activities on the Property, unless the Property Owner receives prior, written approval of an alternative method from the County Engineer:

1. Diagnosis and correction of the Stormwater Facilities malfunctions that cannot be corrected through routine maintenance,
2. Application of fertilizer and/or pest control products within, under, or above the Stormwater Facilities,
3. Repair of private drainage system (including rain gutters, downspouts, area drains, risers, inlets, outlets, overflows, clean-outs, connectors, earthen and concrete conveyance swales, check dam/retaining walls, and catch basins),
4. Maintenance of irrigation system that may affect stormwater reaching the Stormwater Facilities,
5. Modification of site topography through yard and driveway grading that may affect stormwater reaching the Stormwater Facilities,
6. Subdrain cleaning/replacement (including perforated drain pipe), and
7. Replacement of engineered soil and mulch.

The County Engineer may, at any time, revoke approval of an alternate method for the maintenance of the Stormwater Facilities and require the Property Owner to hire a licensed landscape contractor or other licensed professional acceptable to the County Engineer to undertake any of the activities mentioned in this section.

If a dispute should arise between the Property Owner with respect to the necessity for maintenance, the standard of maintenance, the contractor(s) to be engaged to perform any repair or maintenance work, or any other matters pertaining to the operation or maintenance of the Stormwater Facilities, the dispute may be submitted to the County Engineer, in which case the decision of the County Engineer shall be final.

The County recognizes that the Operation and Maintenance Plan may provide for the allocation of Property Owner responsibilities for the maintenance of Stormwater Facilities located on various Lots. However, regardless of the allocation of maintenance responsibilities, the Property Owner of each Lot is responsible for compliance with all of the obligations contained in this Agreement, and all Property Owners will be jointly and severally liable for failure to comply with the terms and conditions set forth in this Agreement and in the Ordinance.

The County may require the Property Owner to amend the Stormwater Control Plan and/or the Operation and Maintenance Plan whenever the County deems amendments necessary to maintain compliance with the NPDES Permit. In that case, the Property Owner shall have the amendments prepared by a licensed engineer and promptly submit the amendments to the County Engineer for review and approval. All amendments proposed by the Property Owner are subject to the prior, written approval of the County Engineer. Whenever the Property Owner requests amendments to the Stormwater Control Plan and/or the Operation and Maintenance Plan, the Property Owner shall pay the County in advance for all staff time spent reviewing and taking action with respect to such request, whether or not the County Engineer approves the proposed amendments. All approved amendments to the Stormwater Control Plan and the Operation and Maintenance Plan will be kept on file at the County Public Works Department. The Property Owner shall promptly comply with all requirements of the Stormwater Control Plan and the Operation and Maintenance Plan, including any approved amendments.

SECTION 2

Inspection by Property Owner: The Property Owner shall inspect, at least annually, the Stormwater Facilities in accordance with this Agreement, including the requirements of the Operation and Maintenance Plan, the Stormwater Control Plan, and the Ordinance. The annual inspection shall include completion of the reporting form(s) required by the County, which form(s) will be provided annually to the Property Owner by the County. The Property Owner or a licensed landscape contractor or other licensed professional acceptable to the County Engineer must submit the reporting form(s) to the County Engineer no later than the deadline indicated on the form(s). Upon review, the County may require additional information from either the Property Owner or an appropriately-licensed contractor.

SECTION 3

Right of Entry and Stormwater Facilities Inspection by the County: The Property Owner hereby grants permission to the County and its contractors and other agencies with an interest in the Stormwater Facilities, such as the Contra Costa County Flood Control and Water Conservation District, the Contra Costa Mosquito and Vector Control District, and the Regional Water Quality Control Board, to enter upon the Property at any reasonable time to inspect, assess, or observe the Stormwater Facilities for the purpose of ensuring that the Stormwater Facilities are being properly maintained and are continuing to perform in an adequate manner to protect water quality and the public health and safety. This includes the right to enter upon the Property whenever the County or other agency has a reasonable basis to believe that a violation of this Agreement, the Operation and Maintenance Plan, the Stormwater Control Plan, the Ordinance, or the NPDES Permit has occurred or is threatening to occur. It also includes the right for the County and its contractors to enter upon the Property to perform any maintenance or other obligations required of the Property Owner under this Agreement or to abate any nuisance in connection with the Stormwater Facilities. The County and the other agencies shall endeavor to provide reasonable notice to the Property Owner before entering the Property.

SECTION 4

Failure to Perform Required Stormwater Facilities Repairs or Maintenance by the Property Owner: If the Property Owner fails to maintain the Stormwater Facilities in good working order and in accordance with the approved Operation and Maintenance Plan, the Stormwater Control Plan, and the Ordinance, the

County, with prior notice, may enter the Property to return the Stormwater Facilities to good working order. The County is under no obligation to maintain or repair the Stormwater Facilities, and this Agreement may not be construed to impose any such obligation on the County. If the County, under this section, performs any work to return Stormwater Facilities to good working order, the Property Owner shall reimburse the County for all the costs incurred by the County, including administrative costs. The County will provide the Property Owner with an itemized invoice of the County's costs and the Property Owner will have 30 days to pay the invoice. If the Property Owner fails to pay the invoice within 30 days, the County may secure a lien against the Property in the amount of such costs. In addition, the County may make the cost of abatement of the nuisance caused by the failure to maintain the Stormwater Facilities a special assessment against the Property, which assessment may be collected on the tax roll in accordance with applicable law. This section does not prevent the County from pursuing other remedies against the Property or the Property Owner, including but not limited to those in the Ordinance and the nuisance abatement procedures in Division 14 of Title 1 (or successor provisions) of the Contra Costa County Ordinance Code.

If the Property Owner fails to maintain the Stormwater Facilities in accordance with this Agreement, the Operation and Maintenance Plan, the Stormwater Control Plan, or the Ordinance, the Property Owner shall be responsible for: (a) the costs of any code enforcement or nuisance abatement actions commenced by the County; and (b) the payment of, or reimbursement to the County for, any fines or penalties that may be levied against the County by the Regional Water Quality Control Board or any other regulatory agency, to the extent that the fines or penalties result from the Property Owner's failure to properly maintain the Stormwater Facilities. The County may recover such costs, fines, or penalties from the Property Owner in the same manner as provided in the preceding paragraph.

SECTION 5

Indemnity: The Property Owner agrees to defend, indemnify, save, and hold harmless the County and its governing board from any and all demands, losses, claims, costs, suits, liabilities, and expenses for any property damage, personal injury, or death arising directly or indirectly from or connected with the design, construction, use, operation or maintenance of the Stormwater Facilities by the Property Owner or the presence or existence of the Stormwater Facilities on the Property, except for claims, costs, or liabilities resulting from the sole negligence or sole willful misconduct of the County. The Property Owner's obligations under this section shall include the payment of penalties, fines, attorneys' fees, experts' fees, costs, and litigation expenses, as well as liability for the release or existence of any hazardous materials on, under, or in the Property. If any action or proceeding is brought against any of the indemnitees, the Property Owner shall reimburse the indemnitees for any expenditures, including reasonable attorneys' fees and costs, incurred by the indemnitees and, if requested by any of the indemnitees, shall defend the action or proceeding at the Property Owner's sole expense with counsel reasonably acceptable to the indemnitees.

SECTION 6

Covenant Running with the Land: The covenants of the Property Owner set forth above shall run with the land, and the burdens of the covenants shall be binding upon each and every part of the Property and upon the Property Owner and the Property Owner's successors and assigns in ownership (on any interest in the Property) for the benefit of Richmond Parkway and Pittsburg Avenue and associated storm drain(s) and each and every part thereof. Said covenants shall inure to the benefit of and be enforceable by the County and its successors and assigns in ownership of each and every part of the above referenced road(s) and storm drains.

SECTION 7

Severability: Invalidation of any one of the provisions of this Agreement shall in no way affect any other provisions and all other provisions shall remain in full force and effect.

SECTION 8

No Dedication for Public Use: The provisions of this Agreement shall not be construed to constitute a dedication for public use, either express or implied, and any actions by the County to enforce this Agreement, including without limitation code enforcement or nuisance abatement actions, shall not be deemed to involve the exercise by the County of dominion or control over the Stormwater Facilities or the Property.

SECTION 9

Notices: All notices required by this Agreement or by law shall be in writing and shall be delivered in person or sent by certified mail, postage pre-paid.

Notices required to be given to the County shall be addressed as follows:

Contra Costa County Public Works Department
Attention: County Watershed Program
255 Glacier Drive
Martinez, CA 94553

Notices required to be given to the Property Owner, including any heirs, successors, or assigns, will be sent to the mailing address for the Property Owner that is on file with the Contra Costa County Assessor. The Property Owner may request in writing that notices be sent to an additional address.

Any party may change its address or contact person by notice in writing to the other party and thereafter notices shall be addressed and transmitted to the new address and/or new contact person.

SECTION 10

Effective Date and Modification: This Agreement is effective upon the date stated at the beginning of this Agreement. This Agreement shall not be modified except by written instrument executed by the County and the Property Owner at the time of modification. Such modifications shall be effective upon the date of execution and shall be recorded.

County of Contra Costa

Property Owner

By: _____
Brian M. Balbas, Public Works Director

By: BTC II Holdco LLC
Member, IPT Richmond DC III LLC

RECOMMENDED FOR APPROVAL:

Brian M. Balbas, Public Works Director

By: _____
Deputy Public Works Director

APPROVED AS TO FORM:

Mary Ann McNett Mason
County Counsel

By: 
Deputy County Counsel

By: Build-To-Core Industrial Partnership II LP
Manager, BTC II Holdco LLC

By: IPT BTC II GP LLC
General Partner, Build-To-Core Industrial
Partnership II LP

By: IPT Real Estate Holdco LLC
Member, IPT BTC II GP LLC

By: BCI IV Portfolio Real Estate Holdco LLC
Member, IPT Real Estate Holdco LLC

By: BCI IV Operating Partnership LP
Member, BCI IV Portfolio Real Estate Holdco
LLC

By: Black Creek Industrial REIT IV Inc.
General Partner, BCI IV Operating Partnership
LP

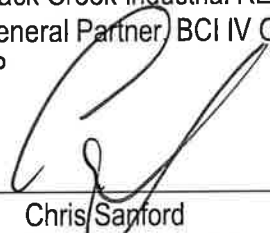
By: 
Chris Sanford
Senior Vice President of Development

[Note: All Property Owner signatures must be notarized. If Property Owner is a California limited liability company, Property Owner must sign in accordance with one of the following: (1) Two managers may sign, but if the articles of organization indicate that the company is managed by only one manager, one manager must sign (Corp. Code, § 17703.01, subd. (d)); (2) subject to the articles of organization, two officers may sign, the first being the chairperson of the board, president or any vice president and the second being any secretary, any assistant secretary, the chief financial officer or any assistant treasurer (Corp. Code, § 17704.07, subd. (w)); or (3) subject to the articles of organization, if the company is not manager-managed, any member may sign. (Corp. Code, § 17703.01, subd. (a).)]

Attachments: Exhibit A (Legal Description)
Exhibit B (Plat to Accompany Legal Description)
Acknowledgment

H:\Public Works\WatershedProgram\OMAg.DP14-3041.2.8.22.docx

EXHIBIT "A"
LEGAL DESCRIPTION ADJUSTED PARCELS

ADJUSTED PARCEL 1

BEING REAL PROPERTY SITUATE IN AN UNINCORPORATED PORTION OF THE COUNTY OF CONTRA COSTA, STATE OF CALIFORNIA, DESCRIBED AS FOLLOWS:

BEING A PORTION OF THE PROPERTY GRANTED TO IPT RICHMOND DC III LLC, IN THAT CERTAIN GRANT DEED, RECORDED ON DECEMBER 03, 2018, AS DOCUMENT NO. 2018-0193756-00, CONTRA COSTA COUNTY RECORDS, AS SAID PROPERTY IS FURTHER DELINEATED UPON THAT CERTAIN RECORD OF SURVEY FILED FOR RECORD MARCH 01, 2019, IN BOOK 158 OF LICENSED SURVEYOR'S MAPS, AT PAGE 2, CONTRA COSTA COUNTY RECORDS AND BEING MORE PARTICULARLY DESCRIBED AS FOLLOWS:

COMMENCING AT THE FOUND MONUMENT AT THE INTERSECTION OF PITTSBURG AVENUE AND RICHMOND PARKWAY AS SHOWN ON SAID SURVEY (158 LSM 2);

THENCE RUNNING ALONG THE MONUMENT LINE OF SAID PITTSBURG AVENUE, SOUTH 88° 50' 13" EAST, 77.01 FEET;

THENCE LEAVING SAID LINE SOUTH 00° 35' 08" WEST, 20.00 FEET, TO A POINT AT THE INTERSECTION OF SOUTHERLY RIGHT OF WAY LINE OF PITTSBURG AVENUE AND THE EASTERLY RIGHT OF WAY LINE OF RICHMOND PARKWAY;

THENCE ALONG THE SAID SOUTHERLY RIGHT OF WAY LINE OF PITTSBURG AVENUE SOUTH 88° 50' 13" EAST, 273.00 FEET, TO THE **POINT OF BEGINNING** OF THIS DESCRIPTION;

THENCE CONTINUING ALONG SAID RIGHT OF WAY LINE, SOUTH 88° 50' 13" EAST, 469.74 FEET, TO AN ANGLE POINT THEREON, AS DESCRIBED IN THAT CERTAIN GRANT DEED TO CONTRA COSTA COUNTY, RECORDED APRIL 12, 1996, AS INSTRUMENT NO. 96-067303, CONTRA COSTA COUNTY RECORDS;

THENCE CONTINUING ALONG SAID RIGHT OF WAY, SOUTH 78° 25' 23" EAST, 188.10 FEET;

THENCE CONTINUING SOUTH 88° 50' 13" EAST, 10.00 FEET, TO A POINT ON THE WESTERLY LINE THE PARCEL GRANTED TO WEST COUNTY RESOURCE RECOVERY, INC, AS DESCRIBED IN THAT CERTAIN GRANT DEED RECORDED JUNE 01, 1995, AS DOCUMENT NO. 95-086866, CONTRA COSTA COUNTY RECORDS;

THENCE ALONG SAID WESTERLY LINE SOUTH 01° 09' 47" WEST, 1043.87 FEET, TO A POINT ON THE NORTHEASTERLY LINE OF THE LANDS CONVEYED TO CONTRA COSTA COUNTY FLOOD CONTROL & WATER CONSERVATION DISTRICT IN THAT CERTAIN GRANT DEED, RECORDED FEBRUARY 21, 1992 IN BOOK 17244, PAGE 49, CONTRA COSTA COUNTY RECORDS;

THENCE ALONG SAID LINE THE FOLLOWING SIX (6) COURSES:

- 1) SOUTH 57° 00' 00" WEST, 440.69 FEET, TO THE POINT OF CURVATURE OF A 2287.15 FOOT RADIUS CURVE TO THE RIGHT,
- 2) ALONG SAID CURVE, THROUGH A CENTRAL ANGLE OF 08° 59' 37", AN ARC DISTANCE OF 359.01 FEET,
- 3) SOUTH 65° 59' 37" WEST, 15.32 FEET, TO THE POINT OF CURVATURE OF A 2513.16 FOOT RADIUS CURVE TO THE LEFT,
- 4) ALONG SAID CURVE, THROUGH A CENTRAL ANGLE OF 04° 17' 42", AND ARC DISTANCE OF 188.39 FEET, TO THE POINT OF REVERSE CURVATURE OF A 77.00 FOOT RADIUS CURVE TO THE RIGHT,
- 5) ALONG SAID CURVE, THROUGH A CENTRAL ANGLE OF 42° 48' 05", AND ARC DISTANCE OF 57.52 FEET, TO THE POINT OF REVERSE CURVATURE OF A 138.01 FOOT RADIUS CURVE TO THE LEFT,
- 6) ALONG SAID CURVE, THROUGH A CENTRAL ANGLE OF 03° 35' 27", AN ARC DISTANCE OF 8.65 FEET, TO A POINT ON THE EASTERLY RIGHT OF WAY LINE OF RICHMOND PARKWAY, AS DESCRIBED IN THAT CERTAIN GRANT DEED TO THE CITY OF RICHMOND, RECORDED MAY 05, 1995, AS INSTRUMENT NO. 95-072493, CONTRA COSTA COUNTY RECORDS;

THENCE ALONG SAID EASTERLY RIGHT OF WAY LINE NORTH 00° 35' 08" EAST, 1367.03 FEET;

THENCE LEAVING SAID LINE SOUTH 89° 24' 52" EAST, 122.15 FEET, TO THE POINT OF CURVATURE OF A 150.00 FOOT RADIUS CURVE TO THE LEFT;

THENCE ALONG SAID CURVE, THROUGH A CENTRAL ANGLE OF 89° 25' 21", AN ARC DISTANCE OF 234.11 FEET;

THENCE NORTH 01° 09' 47" EAST, 83.76 FEET, TO THE **POINT OF BEGINNING.**

CONTAINING 1,214,447 SQUARE FEET OR 27.8799 ACRES OF LAND, MORE OR LESS.

ADJUSTED PARCEL 2

BEING REAL PROPERTY SITUATE IN AN UNINCORPORATED PORTION OF THE COUNTY OF CONTRA COSTA, STATE OF CALIFORNIA, DESCRIBED AS FOLLOWS:

BEING A PORTION OF THE PROPERTY GRANTED TO IPT RICHMOND DC III LLC, IN THAT CERTAIN GRANT DEED, RECORDED ON DECEMBER 03, 2018, AS DOCUMENT NO. 2018-0193756-00, CONTRA COSTA COUNTY RECORDS, AS SAID PROPERTY IS FURTHER DELINEATED UPON THAT CERTAIN RECORD OF SURVEY FILED FOR RECORD MARCH 01, 2019, IN BOOK 158 OF LICENSED SURVEYOR'S MAPS, AT PAGE 2, CONTRA COSTA COUNTY RECORDS AND BEING MORE PARTICULARLY DESCRIBED AS FOLLOWS:

COMMENCING AT THE FOUND MONUMENT AT THE INTERSECTION OF PITTSBURG AVENUE AND RICHMOND PARKWAY AS SHOWN ON SAID SURVEY (158 LSM 2);

THENCE RUNNING ALONG THE MONUMENT LINE OF SAID PITTSBURG AVENUE, SOUTH 88° 50' 13" EAST, 77.01 FEET;

THENCE LEAVING SAID LINE SOUTH 00° 35' 08" WEST, 20.00 FEET, TO A POINT AT THE INTERSECTION OF SOUTHERLY RIGHT OF WAY LINE OF PITTSBURG AVENUE AND THE EASTERLY RIGHT OF WAY LINE OF RICHMOND PARKWAY, SAID POINT ALSO BEING THE **POINT OF BEGINNING** OF THIS DESCRIPTION;

THENCE ALONG THE SAID SOUTHERLY RIGHT OF WAY LINE OF PITTSBURG AVENUE SOUTH 88° 50' 13" EAST, 273.00 FEET;

THENCE LEAVING SAID LINE SOUTH 01° 09' 47" WEST, 83.76 FEET, TO THE POINT OF CURVATURE OF A 150.00 FOOT RADIUS CURVE TO THE RIGHT;

THENCE ALONG SAID CURVE, THROUGH A CENTRAL ANGLE OF 89° 25' 21", AN ARC DISTANCE OF 234.11 FEET;

THENCE NORTH 89° 24' 52" WEST, 122.15 FEET, TO A POINT ON THE EASTERLY RIGHT OF WAY LINE OF RICHMOND PARKWAY, AS DESCRIBED IN THAT CERTAIN GRANT DEED TO THE CITY OF RICHMOND, RECORDED MAY 05, 1995, AS INSTRUMENT NO. 95-072493, CONTRA COSTA COUNTY RECORDS;

THENCE ALONG SAID EASTERLY RIGHT OF WAY LINE NORTH 00° 35' 08" EAST, 235.00 FEET, TO THE **POINT OF BEGINNING**.

CONTAINING 58,788 SQUARE FEET OR 1.3496 ACRES OF LAND, MORE OR LESS.

KIER & WRIGHT CIVIL ENGINEERS & SURVEYORS, INC.



GARY K. LAMB, P.L.S. 6627

10-28-21
DATE

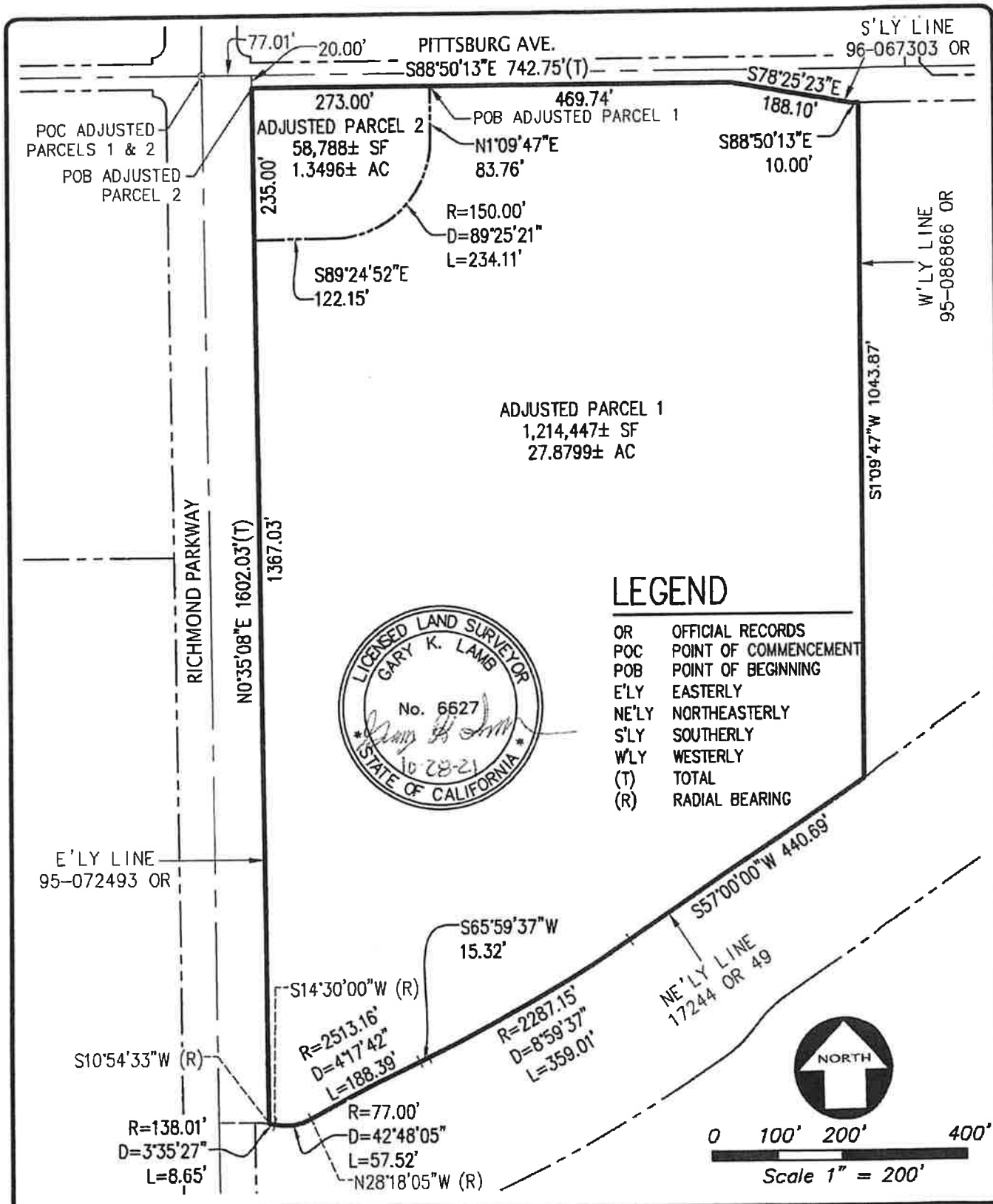

KIER+WRIGHT
 2850 Collier Canyon Road
 Livermore, California 94551
 Phone (925) 245-8788
 www.kierwright.com

EXHIBIT "B"
TO ACCOMPANY
LEGAL DESCRIPTION
 RICHMOND, CALIFORNIA

DATE	OCT., 2021
SCALE	1" = 200'
BY	GKL
JOB NO.	A18625-1
SHEET	1 OF 1

CALIFORNIA ALL-PURPOSE ACKNOWLEDGMENT

CIVIL CODE § 1189

A notary public or other officer completing this certificate verifies only the identity of the individual who signed the document to which this certificate is attached, and not the truthfulness, accuracy, or validity of that document.

State of California)
County of Orange)
On February 14, 2022 before me, Julie L. Dennis, Notary Public
Date Here Insert Name and Title of the Officer
personally appeared Chris Sanford
Name(s) of Signer(s)

who proved to me on the basis of satisfactory evidence to be the person~~(e)~~ whose name~~(e)~~ is/~~are~~ subscribed to the within instrument and acknowledged to me that he/~~she/they~~ executed the same in his/~~her/their~~ authorized capacity~~(ies)~~, and that by his/~~her/their~~ signature~~(s)~~ on the instrument the person~~(s)~~, or the entity upon behalf of which the person~~(s)~~ acted, executed the instrument.

I certify under PENALTY OF PERJURY under the laws of the State of California that the foregoing paragraph is true and correct.

WITNESS my hand and official seal.



Signature Julie L. Dennis
Signature of Notary Public

Place Notary Seal Above

OPTIONAL

Though this section is optional, completing this information can deter alteration of the document or fraudulent reattachment of this form to an unintended document.

Description of Attached Document

Title or Type of Document: _____ Document Date: _____

Number of Pages: _____ Signer(s) Other Than Named Above: _____

Capacity(ies) Claimed by Signer(s)

Signer's Name: _____

Corporate Officer — Title(s): _____

Partner — Limited General

Individual Attorney in Fact

Trustee Guardian or Conservator

Other: _____

Signer Is Representing: _____

Signer's Name: _____

Corporate Officer — Title(s): _____

Partner — Limited General

Individual Attorney in Fact

Trustee Guardian or Conservator

Other: _____

Signer Is Representing: _____

Recorded at the request of: Clerk of the Board

Return To: Public Works Dept- Simone Saleh

THE BOARD OF SUPERVISORS OF CONTRA COSTA COUNTY, CALIFORNIA
and for Special Districts, Agencies and Authorities Governed by the Board

Adopted this Resolution on 03/08/2022 by the following vote:

AYE: John Gioia, District I Supervisor Candace Andersen, District II Supervisor Diane Burgis, District III Supervisor Karen Mitchoff, District IV Supervisor Federal D. Glover, District V Supervisor

NO:

ABSENT:

ABSTAIN:

RECUSE:

Resolution No. 2022/67

IN THE MATTER OF approving the Stormwater Management Facilities Operation and Maintenance Agreement for development plan permit DP14-03041 (APNs 408-180-012 and 408-180-013), Richmond area. (District I)

WHEREAS the Public Works Director has recommended that he be authorized to execute the Stormwater Management Facilities Operation and Maintenance Agreement with IPT Richmond DC III LLC, as required by the Conditions of Approval for development plan permit DP14-03041. This agreement would ensure the operation and maintenance of the stormwater facilities in accordance with the approved Stormwater Control Plan and approved Operation and Maintenance Plan for development plan permit DP14-03041, which is located at 500 Pittsburg Avenue in the Richmond area.

NOW, THEREFORE, BE IT RESOLVED that the recommendation of the Public Works Director is APPROVED.

I hereby certify that this is a true and correct copy of an action taken and entered on the minutes of the Board of Supervisors on the date shown.

ATTESTED: March 8, 2022

Monica Nino, County Administrator and Clerk of the Board of Supervisors

Stacey M. Boyd
By: Stacey M. Boyd, Deputy

Contact: Randolph Sanders (925) 313-2111

cc: Larry Gossett- Engineering Services, Randolph Sanders- Engineering Services, Ronald Lai, Engineering Services, Michelle Mancuso- Watershed Program, Flood Control, John Steere, Watershed Program, Flood Control, Catherine Windham, Flood Control, Renee Hutchins - Records, Karen Piona- Records, Ruben Hernandez - DCD, IPT Richmond DC III LLC



**Contra
Costa
County**

To: Board of Supervisors
From: Director of Airports
Date: March 8, 2022

Subject: APPROVE and AUTHORIZE the Director of Airports, or designee, to execute a hangar rental agreement with Buchanan Field Airport Hangar tenant

RECOMMENDATION(S):

APPROVE and AUTHORIZE the Director of Airports, or designee, to execute a month-to-month hangar rental agreement with Robert Meinbress and Eric Meinbress, for a south-facing medium hangar at Buchanan Field Airport effective February 15, 2022, in the monthly amount of \$482.00, Pacheco area (District IV).

FISCAL IMPACT:

The Airport Enterprise Fund will realize \$5,784.00 annually.

BACKGROUND:

On November 14, 2006, the Contra Costa County Board of Supervisors approved the form of the T-Hangar and Shade Hangar Rental Agreement for use with renting the County's t-hangars, shade hangars, medium hangars, and executive hangars at Buchanan Field Airport.

On February 23, 2007, Contra Costa County Board of Supervisors approved the new Large Hangar Rental Agreement for use with the large East Ramp Hangars.

On January 16, 2009, Contra Costa County Board of Supervisors approved an amendment to the T-Hangar and Shade Hangar

-
- APPROVE OTHER
 - RECOMMENDATION OF CNTY ADMINISTRATOR RECOMMENDATION OF BOARD COMMITTEE
-

Action of Board On: **03/08/2022** APPROVED AS RECOMMENDED OTHER

Clerks Notes:

VOTE OF SUPERVISORS

- AYE: John Gioia, District I Supervisor
 Candace Andersen, District II Supervisor
 Diane Burgis, District III Supervisor
 Karen Mitchoff, District IV Supervisor
 Federal D. Glover, District V Supervisor

I hereby certify that this is a true and correct copy of an action taken and entered on the minutes of the Board of Supervisors on the date shown.

ATTESTED: March 8, 2022

Monica Nino, County Administrator and Clerk of the Board of Supervisors

By: Stacey M. Boyd, Deputy

Contact: Beth Lee, 925-681-4200

cc:

BACKGROUND: (CONT'D)

Rental Agreement and the Large Hangar Rental Agreement (combined "Hangar Rental Agreements"). The Hangar Rental Agreements are the current forms in use for rental of all the County hangars at Buchanan Field Airport.

CONSEQUENCE OF NEGATIVE ACTION:

A negative action will cause a loss of revenue to the Airport Enterprise Fund.

ATTACHMENTS

Hangar Rental Agmt pg 4-5 R & E Meinbress

CONTRA COSTA COUNTY - BUCHANAN FIELD AIRPORT

T-HANGAR AND SHADE HANGAR RENTAL AGREEMENT

1. **PARTIES: February 15, 2022** (“Effective Date”), the COUNTY OF CONTRA COSTA, a political subdivision of the State of California (“Airport”), **Robert Meinbress and Eric Meinbress** (“Renter”), hereby mutually agree and promise as follows:

2. **RENTER AND AIRCRAFT INFORMATION:** Simultaneous with the execution of this T-Hangar and Shade Hangar Rental Agreement (“**Rental Agreement**”) by Renter, Renter shall complete the Renter and Aircraft Information Form. A completed copy of the Renter and Aircraft Information Form is attached hereto as Exhibit “A” and incorporated herein. Renter must also provide to Airport at that time, for inspection and copying, (1) the original current Aircraft Registration or, if the aircraft described in Exhibit A is under construction, the plans for and proof of ownership of such aircraft; and (2) the insurance information required by Section 16 below.

3. **PURPOSE:** The purpose of this Rental Agreement is to provide for the rental of a T-Hangar or Shade Hangar space at the Contra Costa County - Buchanan Field Airport for the storage of the aircraft described in the Renter and Aircraft Information Form (“**Renter’s Aircraft**”).

4. **PREMISES:** For and in consideration of the rents and faithful performance by Renter of the terms and conditions set forth herein, Airport hereby rents to Renter and Renter hereby rents from Airport that T-Hangar or Shade Hangar shown as # **A-2** on the T-Hangar and Shade Hangar Site Plan, attached hereto as Exhibit B and incorporated herein. This T-Hangar or Shade Hangar is part of the T-Hangar and Shade Hangar Site (“**T-Hangar Site**”) and shall hereinafter be described as the “**T-Hangar.**”

Renter has inspected the T-Hangar and hereby accepts the T-Hangar in its present condition, as is, without any obligation on the part of Airport to make any alterations, improvements, or repairs in or about the T-Hangar.

5. **USE:** The T-Hangar shall be exclusively by Renter for the storage of Renter’s Aircraft. In addition to the storage of Renter’s Aircraft, Renter may use the T-Hangar for (1) the homebuilding, restoration and/or maintenance of Renter’s Aircraft, provided that such homebuilding, restoration and/or maintenance is performed by Renter only and in conformance with all applicable statutes, ordinances, resolutions, regulations, orders, circulars (including but not limited to FAA Advisory Circular 20-27) and policies now in existence or adopted from time to time by the United States, the State of California, the County of Contra Costa and other government agencies

with jurisdiction over Buchanan Field Airport; (2) the storage of and materials directly related to the storage, construction of homebuilt planes homebuilding, restoration, and/or maintenance of Renter's Aircraft; (3) the storage of one boat, or one recreational vehicle, or one motorcycle, or one automobile, provided that Renter first provides to Airport proof of Renter's ownership and original registration of any stored boat or vehicle, for inspection and copying; and/or (4) the storage of comfort items (such as a couch, small refrigerator, etc.) that the Director of Airports, in his sole discretion, determines will not impede the use of the hangar for the storage of Renter's Aircraft, and are not prohibited by applicable building and fire codes. The T-Hangar shall not be used for any purpose not expressly set forth in this Section 5. Use.

The use of all or a portion of the T-Hangar for the storage of aircraft not owned or leased by Renter is prohibited. ("Aircraft not owned or leased by Renter" means any aircraft in which Renter does not have an ownership interest or which is not directly leased to Renter). Renter shall present proof of said ownership interest or lease to Airport upon request in addition to that information provided in Exhibit A.

If Renter's Aircraft is or becomes non-operational, it may be stored in the T-Hangar only if it is being homebuilt or restored by Renter. Prior to the commencement of any such homebuilding or restoration, Renter shall provide to Airport (1) a copy of the purchase agreement or (2) a valid federal registration number. If Renter's Aircraft is not registered as of the Effective Date, upon completion of construction, Renter shall register and apply for an airworthiness certificate for Renter's Aircraft in accordance with all applicable federal statutes and regulations and provide the original registration and certification to Airport, for inspection and copying, immediately upon receipt by Renter. On or before January 1 of each year, if the homebuilding or restoration has not been completed, Renter shall provide a written annual report to the Director of Airports that details the homebuilding or restoration activity performed, work still required to be completed and an estimate of time of completion.

6. **TERM:** This Rental Agreement shall be from month to month commencing **February 15, 2022**, and shall continue until terminated. This Rental Agreement may be terminated by any party upon thirty (30) days written notice to the other party.

7. **RENT:**

A. **Monthly Rent and Additional Rent.** Renter shall pay \$ **482.00** in rent per month ("**Monthly Rent**") due and payable in advance on the first day of each calendar month, beginning on the commencement date of this Rental Agreement. Unless directed to do otherwise by Airport, Renter shall pay rent only in cash or by personal check, certified check, or money order. If the term of this Rental Agreement begins on a day other than the first day of the month, the Monthly Rent stated above for the first month shall be prorated



Contra
Costa
County

To: Board of Supervisors
From: Director of Airports
Date: March 8, 2022

Subject: Acceptance of Federal Aviation Administration Grant Funding to Build a New Air Traffic Control Tower at Buchanan Field

RECOMMENDATION(S):

AUTHORIZE the Director of Airports or designee to submit an Airport Improvement Program (AIP) grant application to both the Federal Aviation Administration (FAA) and the California Department of Transportation-Division of Aeronautics (Caltrans) for approximately \$20,700,000 and \$150,000, respectively, to design, perform environmental analysis, and replace the Air Traffic Control Tower at Buchanan Field, Pacheco area (District IV).

APPROVE and AUTHORIZE the Chair of the Board of Supervisors to sign a Statement of Acceptance with the Federal Aviation Administration for up to \$20,700,000 of grant funds to design, perform environmental analysis, and replace the Air Traffic Control Tower.

APPROVE and AUTHORIZE the Director of Airports, or designee, to sign an acceptance of up to \$150,000 of funds under the California Aid to Airports Program Grant Agreement-Federal AIP Matching Funds grant program to design, perform environmental analysis, and replace the Air Traffic Control Tower.

APPROVE

OTHER

RECOMMENDATION OF CNTY ADMINISTRATOR

RECOMMENDATION OF BOARD COMMITTEE

Action of Board On: **03/08/2022** APPROVED AS RECOMMENDED OTHER

Clerks Notes:

VOTE OF SUPERVISORS

AYE: John Gioia, District I Supervisor
Candace Andersen, District II Supervisor
Diane Burgis, District III Supervisor
Karen Mitchoff, District IV Supervisor
Federal D. Glover, District V Supervisor

I hereby certify that this is a true and correct copy of an action taken and entered on the minutes of the Board of Supervisors on the date shown.

ATTESTED: March 8, 2022

Monica Nino, County Administrator and Clerk of the Board of Supervisors

By: Stacey M. Boyd, Deputy

Contact: Beth Lee, 925-681-4200

cc:

FISCAL IMPACT:

There is no negative impact on the General Fund. The total cost of the project will be approximately \$23,000,000. This amount will be fully funded as follows: 90% (\$20,700,000) by the FAA, 4.5% (\$150,000 maximum or .72%) by Caltrans, and 5.5% (\$2,150,000 or 9.28%) by the Airport Enterprise Fund.

BACKGROUND:

Buchanan Field Airport is an important regional transportation asset for the greater San Francisco and East Bay area of Northern California. Buchanan Field is a commercial service, reliever airport for the two nearby large and medium hub commercial airports: San Francisco and Oakland International Airports respectively. Further, Buchanan Field is one of the busiest general aviation airports in the United States and currently has over 400 based aircraft, including 22 jets, plus over 39 businesses. In the 2012 FAA report entitled General Aviation Airports: A National Asset Study, Buchanan Field was ranked as one of the 84 most significant airports in the United States, out of more than 2,952 general aviation facilities.

Although the current air traffic control tower (ATCT) was paid for by federal money when it was constructed 60 years ago and is staffed by federal employees, the ATCT is, in fact, owned by Contra Costa County.

The County has had a long-term successful partnership with the FAA to leverage the federal, state and local funds necessary to maintain the 73-year-old Airport infrastructure. The ATCT, however, is over 60 years old and there is insufficient local funding to bring the facility up to current federal standards (such as seismic, Architectural Barriers Act Accessibility Standards, and ADA/OSHA) and/or to perform major system or structural upgrades (such as a new roof and siding, plumbing, HVAC system, and the like).

As such, the ATCT is at the end of its useful life and needs to be replaced for the health and safety of the FAA employees and the Airport users. This project would further public safety and the public benefit by relocating the ATCT to a different location on the Airport which offers better visibility of the four runways and associated taxiways.

The FAA grant funding would be used to design, perform the environmental analysis and construct a new Air Traffic Control Tower at Buchanan Field. The FAA typically funds 90% of the cost of the project, the balance of the cost will be paid for through a combination of grant funding from Caltrans (in the amount of \$150,000) and capital reserves from the Airport Enterprise Fund (in the amount of \$2,150,000).

CONSEQUENCE OF NEGATIVE ACTION:

The County will not receive the FAA and Caltrans Grant funding necessary to replace the Air Traffic Control Tower at Buchanan Field, which will result in the project not being completed.



Contra
Costa
County

To: Board of Supervisors
From: Monica Nino, County Administrator
Date: March 8, 2022

Subject: Claims

RECOMMENDATION(S):

DENY claims filed by Donald Benson, Julie Chu, Arturo Mendez, Chris and Kim Rivielle; DENY amended claim filed by Ronald Schaefer, individually and as the successor in-interest to the Estate of Joshua Schaefer.

FISCAL IMPACT:

No fiscal impact.

BACKGROUND:

Donald Benson: Property claim for damage to door in the amount of \$1,098.
Julie Chu: Property claim for damage to vehicle in the amount of \$385.23.
Arturo Mendez: Property claim for damage to vehicle in an unspecified amount.
Chris & Kim Rivielle: Property claim for damage to vehicle in the amount of \$23,882.
Ronald Schaefer: Amended wrongful death claim due to a dangerous condition in an undisclosed amount.

CONSEQUENCE OF NEGATIVE ACTION:

Not acting on the claims could extend the claimants' time limits to file actions against the County.

APPROVE

OTHER

RECOMMENDATION OF CNTY ADMINISTRATOR

RECOMMENDATION OF BOARD COMMITTEE

Action of Board On: **03/08/2022** APPROVED AS RECOMMENDED OTHER

Clerks Notes:

VOTE OF SUPERVISORS

AYE: John Gioia, District I Supervisor
Candace Andersen, District II Supervisor
Diane Burgis, District III Supervisor
Karen Mitchoff, District IV Supervisor
Federal D. Glover, District V Supervisor

I hereby certify that this is a true and correct copy of an action taken and entered on the minutes of the Board of Supervisors on the date shown.

ATTESTED: March 8, 2022

Monica Nino, County Administrator and Clerk of the Board of Supervisors

By: Stacey M. Boyd, Deputy

Contact: Risk Management

cc:



Contra
Costa
County

To: Board of Supervisors
From: Mary Ann Mason, County Counsel
Date: March 8, 2022

Subject: Public report of litigation settlement agreements that became final during the period of February 1, 2022, through February 28, 2022.

RECOMMENDATION(S):

RECEIVE public report of litigation settlement agreements that became final during the period of February 1, 2022, through March 3, 2022, as recommended by County Counsel.

FISCAL IMPACT:

Settlement amounts are listed below.

BACKGROUND:

Three agreements to settle pending litigation, as defined in Government Code section 54956.9, became final during the period of February 1, 2022, through March 3, 2022.

In re National Prescription Opiate Litigation, USDC Case No. 1:17-md-0284-DAP (N.D. Ohio.) On December 7, 2021, the Board approved settlement of the national opioid litigation in closed session by a 5-0 vote. Under the settlement agreement, the County will release claims against defendants Amerisource Bergen, Cardinal Health, McKesson, and Johnson & Johnson in exchange for the County's proportionate share of opiate remediation funds. The total nationwide settlement is \$26 billion paid out over 18 years. The County's share will be an estimated \$32 million paid over 18 years, or \$1.7 million per year. The settlement

APPROVE

OTHER

RECOMMENDATION OF CNTY ADMINISTRATOR

RECOMMENDATION OF BOARD COMMITTEE

Action of Board On: **03/08/2022** APPROVED AS RECOMMENDED OTHER

Clerks Notes:

VOTE OF SUPERVISORS

AYE: John Gioia, District I Supervisor
Candace Andersen, District II Supervisor
Diane Burgis, District III Supervisor
Karen Mitchoff, District IV Supervisor
Federal D. Glover, District V Supervisor

I hereby certify that this is a true and correct copy of an action taken and entered on the minutes of the Board of Supervisors on the date shown.

ATTESTED: March 8, 2022

Monica Nino, County Administrator and Clerk of the Board of Supervisors

Contact: Thomas Geiger, Assistant County Counsel,
655-2200

By: Stacey M. Boyd, Deputy

cc: Thomas Geiger, Assistant County Counsel, Karen Caolie, Risk Manager

BACKGROUND: (CONT'D)

became final on February 25, 2022.

Christopher Garcia v. Aaron Heath-Paez, et al., CCC Sup. Ct. Case No. C18-02361. On December 14, 2021, the Board of Supervisors approved a settlement in this action involving an automobile accident. The Board authorized settlement in the amount of \$285,000, inclusive of attorneys' fees and costs, in closed session by a 4-0 vote, Supervisor Burgis absent. The County will pay \$185,000 of the settlement amount with Allstate paying the rest. The funding source for the County's portion is the Risk Management Liability Internal Service Fund. The settlement agreement was fully executed on February 17, 2022.

Diane Wilson, et al. v. Town of Danville, et al., USDC Case No. 3:21-cv-02440 TSH (N.D. Cal.). On February 22, 2022, the Board of Supervisors approved a settlement in this civil rights wrongful death action. The Board authorized settlement in the amount of \$4.5 million, inclusive of attorneys' fees and costs, in closed session by a 5-0 vote. The funding source is the Risk Management Liability Internal Service Fund. The settlement agreement was fully executed on March 3, 2022.

This report includes final settlements of litigation matters handled by the Office of the County Counsel. This report does not include litigation settlements that were reported by the Risk Management Division of the County Administrator's Office as a consent item on the Board's open session agenda.

CONSEQUENCE OF NEGATIVE ACTION:

The report would not be accepted.



Contra
Costa
County

To: Board of Supervisors
From: Kathy Gallagher, Employment & Human Services Director
Date: March 8, 2022

Subject: Proclaim the Month of March 2022 as Social Work Month

APPROVE

OTHER

RECOMMENDATION OF CNTY ADMINISTRATOR

RECOMMENDATION OF BOARD COMMITTEE

Action of Board On: **03/08/2022** APPROVED AS RECOMMENDED OTHER

Clerks Notes:

VOTE OF SUPERVISORS

AYE: John Gioia, District I Supervisor
Candace Andersen, District II Supervisor
Diane Burgis, District III Supervisor
Karen Mitchoff, District IV Supervisor
Federal D. Glover, District V Supervisor

I hereby certify that this is a true and correct copy of an action taken and entered on the minutes of the Board of Supervisors on the date shown.

ATTESTED: March 8, 2022

Monica Nino, County Administrator and Clerk of the Board of Supervisors

By: Antonia Welty, Deputy

Contact: Tish Gallegos 8-4808

cc:

ATTACHMENTS

Resolution

2022/65

*The Board of Supervisors of
Contra Costa County, California*

In the matter of:

Resolution No. 2022/65

Proclaiming March 2022 as Social Work Month in Contra Costa County

WHEREAS, the Social Work Profession is dedicated to improving human well-being and enhancing the basic needs of all people, especially the most vulnerable among us;

WHEREAS, the 2022 National Social Work Month theme, *The Time is Right for Social Work*, embodies how Social Workers rose to meet the most pressing challenges of these times, the COVID-19 pandemic, systemic racism, economic inequality, global warming and other crises;

WHEREAS, Social Workers in Children and Family Services continue supporting families to protect children from abuse and neglect, find foster and adoptive homes for children, and help families reunite;

WHEREAS, Social Workers in Aging and Adult Services provide comprehensive assessment and intervention through In-Home Support Services, assessment and advocacy on behalf of disabled clients, investigation of emotional abuse, sexual abuse, financial exploitation, neglect and isolation of the elderly and disabled adults, and referrals to resources and support to help ensure safety and independence;

WHEREAS, Social Workers in Workforce Services determine job readiness, and assist clients in finding resources to overcome employment barriers;

WHEREAS, Social Workers continue advocating, as they have for generations, for positive changes to how we all live, including upholding social safety net programs that help eliminate hunger, homelessness, and poverty, ensuring the availability of affordable, high-quality health care, and delivering mental health support;

WHEREAS, Social Workers have always been present in times of crisis, helping people overcome issues such as death and grief, and helping communities recover from natural disasters such as fires, earthquakes and floods;

WHEREAS, Social Workers empower people in our County to live to their fullest potential;

WHEREAS, the Social Work profession is one of the fastest growing in the United States, with more than 715,000 in the profession today, and nearly 800,000 expected to be employed as social workers by 2028;

WHEREAS, Social Workers possess the necessary expertise to assist our County with some of its most demanding concerns, including ensuring equal rights, improved health care and mental health care for all; and immigration reform;

that in recognition of the numerous contributions that Contra Costa County's Social Workers make, we proclaim the month of March 2022 as Social Work Month in celebration and support of the social work profession.

KAREN MITCHOFF

Chair, District IV Supervisor

JOHN GIOIA

District I Supervisor

CANDACE ANDERSEN

District II Supervisor

DIANE BURGIS

District III Supervisor

FEDERAL D. GLOVER

District V Supervisor

I hereby certify that this is a true and correct copy of an action taken and entered on the minutes of the Board of Supervisors on the date shown.

ATTESTED: March 8, 2022

Monica Nino, County Administrator

By: _____, Deputy

Contra
Costa
County



To: Board of Supervisors
From: Federal D. Glover, District V Supervisor
Date: March 8, 2022

Subject: Resolution for Charles Boykins

APPROVE OTHER
 RECOMMENDATION OF CNTY ADMINISTRATOR RECOMMENDATION OF BOARD COMMITTEE

Action of Board On: **03/08/2022** APPROVED AS RECOMMENDED OTHER

Clerks Notes:

VOTE OF SUPERVISORS

AYE: John Gioia, District I Supervisor
Candace Andersen, District II Supervisor
Diane Burgis, District III Supervisor
Karen Mitchoff, District IV Supervisor
Federal D. Glover, District V Supervisor

I hereby certify that this is a true and correct copy of an action taken and entered on the minutes of the Board of Supervisors on the date shown.

ATTESTED: March 8, 2022

Monica Nino, County Administrator and Clerk of the Board of Supervisors

By: Antonia Welty, Deputy

Contact: Vivian Lee - 925-608-4200

cc:

ATTACHMENTS

Resolution

2022/68

*The Board of Supervisors of
Contra Costa County, California*

In the matter of:

Resolution No. 2022/68

**CONTRA COSTA COUNTY BOARD OF SUPERVISORS RECOGNIZING CHARLES BOYKINS EAST BAY
STANDDOWN COORDINATOR**

WHEREAS, *Charles Boykins is a US Army Veteran. He served 12 years as an Avionic Mechanic, working on Blackhawk helicopters; and*

WHEREAS, *After the military, Charles Boykins worked as a Postal Worker and fell on hard times. He and his family attended the first East Bay Standdown (EBSB) in 1999, where Charles was able to regain his momentum and obtain housing for him and his family; and*

WHEREAS, *He returned to EBSB the following year, but this time as a volunteer, serving as a Tent Leader. In this role, he slept in the same tent and directly helped other Veterans who were homeless. The year after, he returned to EBSB again as the Tent Leader Coordinator, an even larger role that is responsible for all Tent Leaders; and*

WHEREAS, *He has remained in this role since, having now volunteered thousands of hours of community service during 12 East Bay Standdowns. Charles is married to Suany Boykins and is very proud that all three of his children have graduated college; and*

WHEREAS, *East Bay Standdown's goals have been to provide a respite from the streets so that needy and homeless Veterans can examine avenues of assistance. They help to place the participants into residential programs, offer employment, comprehensive medical and dental care, provide follow-up programs of various types, and all new clothing and boots.*

NOW, THEREFORE, *by virtue of the authority vested in me as Vice-Chair of the Board of Supervisors of Contra Costa County, I hereby with immense pleasure extend congratulations to Charles Boykins' commitment to the community, family and life in Contra Costa County, California as demonstrated through this recognition of Charles Boykins.*

KAREN MITCHOFF

Chair, District IV Supervisor

JOHN GIOIA

District I Supervisor

CANDACE ANDERSEN

District II Supervisor

DIANE BURGIS

District III Supervisor

FEDERAL D. GLOVER

District V Supervisor

I hereby certify that this is a true and correct copy of an action taken and entered on the minutes of the Board of Supervisors on the date shown.

ATTESTED: March 8, 2022

Monica Nino, County Administrator

By: _____, Deputy



Contra
Costa
County

To: Board of Supervisors
From: Karen Mitchoff, District IV Supervisor
Date: March 8, 2022

Subject: In the Matter of Recognizing American Red Cross Month as March 2022

APPROVE OTHER
 RECOMMENDATION OF CNTY ADMINISTRATOR RECOMMENDATION OF BOARD COMMITTEE

Action of Board On: **03/08/2022** APPROVED AS RECOMMENDED OTHER

Clerks Notes:

VOTE OF SUPERVISORS

AYE: John Gioia, District I Supervisor
Candace Andersen, District II Supervisor
Diane Burgis, District III Supervisor
Karen Mitchoff, District IV Supervisor
Federal D. Glover, District V Supervisor

I hereby certify that this is a true and correct copy of an action taken and entered on the minutes of the Board of Supervisors on the date shown.

ATTESTED: March 8, 2022

Monica Nino, County Administrator and Clerk of the Board of Supervisors

By: Antonia Welty, Deputy

Contact: Colleen Awad, 925-521-7100

cc:

ATTACHMENTS

Resolution
2022/70

*The Board of Supervisors of
Contra Costa County, California*

In the matter of:

Resolution No. 2022/70

In the Matter of Recognizing American Red Cross Month as March 2022

WHEREAS, in times of crisis, people in the County of Contra Costa come together to care for one another. This humanitarian spirit is part of the foundation of our community and is exemplified by American Red Cross volunteers and donors. March is American Red Cross Month, a special time to honor the kindness of our volunteers and neighbors who aid families in need every day as they carry out the organization's 140-year mission of preventing and alleviating suffering; and

WHEREAS, despite the ongoing challenges presented by the COVID-19 pandemic, people have stepped up to help others in need. Whether it was responding to this year's record-breaking wildfires, horrific tornadoes, extreme winter storm cold waves or summer heat waves, volunteers continued to roll up their sleeves to give blood when our country faced a severe blood shortage; and

WHEREAS, last year in Contra Costa County, 518 families affected by 130 devastating home fires, relied on the **American Red Cross and our partners for comfort and hope**, providing emotional support, addressing immediate needs and helping families recover with emergency financial assistance or community resources. Through our Sound the Alarm program we made 108 households safer by helping residents create a fire evacuation plan; and

WHEREAS, Contra Costa County residents donated 17,277 units of lifesaving blood; hosted 788 blood drives, including working several partner sponsored diverse blood drives to help the fight against Sickle Cell Anemia. 8,486 local community members took classes to learn skills like first aid and CPR that save lives; 910 military members and their families received support and services; and humanitarian aid was provided internationally; and

WHEREAS, Red Cross volunteers deployed 552 times, dedicating 61,930 volunteers hours to assist neighbors in California and around the country during 41 different disaster relief operations of all sizes, including wildfires in Oregon and California and Hurricane Ida;

WHEREAS, their work to prevent and alleviate human suffering is vital to strengthening our community's resilience. We dedicate this month of March to all those who continue to advance the noble legacy of American Red Cross founder Clara Barton, who lived by her words, "You must never think of anything except the need, and how to meet it." We ask others to join in this commitment to give back in our community.

NOW, THEREFORE BE IT RESOLVED, by virtue of the authority vested in the County of Contra Costa, does hereby proclaim March 2022 as Red Cross Month. We encourage all Americans to reach out and support its humanitarian mission.

KAREN MITCHOFF

Chair, District IV Supervisor

JOHN GIOIA

District I Supervisor

CANDACE ANDERSEN

District II Supervisor

DIANE BURGIS

District III Supervisor

FEDERAL D. GLOVER

District V Supervisor

I hereby certify that this is a true and correct copy of an action taken and entered on the minutes of the Board of Supervisors on the date shown.

ATTESTED: March 8, 2022

Monica Nino, County Administrator

By: _____, Deputy

Contra
Costa
County



To: Board of Supervisors
From: John Gioia, District I Supervisor
Date: March 8, 2022

Subject: Declaring February 28, 2022 Rare Disease Day in Contra Costa County

APPROVE

OTHER

RECOMMENDATION OF CNTY ADMINISTRATOR

RECOMMENDATION OF BOARD COMMITTEE

Action of Board On: **03/08/2022** APPROVED AS RECOMMENDED OTHER

Clerks Notes:

VOTE OF SUPERVISORS

AYE: John Gioia, District I Supervisor
Candace Andersen, District II Supervisor
Diane Burgis, District III Supervisor
Karen Mitchoff, District IV Supervisor
Federal D. Glover, District V Supervisor

I hereby certify that this is a true and correct copy of an action taken and entered on the minutes of the Board of Supervisors on the date shown.

ATTESTED: March 8, 2022

Monica Nino, County Administrator and Clerk of the Board of Supervisors

By: Antonia Welty, Deputy

Contact: Robert Rogers, 510.942.2224

cc:

ATTACHMENTS

Resolution

2022/74

*The Board of Supervisors of
Contra Costa County, California*

In the matter of:

Resolution No. 2022/74

Declaring February 28, 2022 Rare Disease Day in Contra Costa County

Whereas, there are nearly 7,000 diseases and conditions considered rare (each affecting fewer than 200,000 Americans) in the United States, according to the National Institutes of Health (NIH);

Whereas, while each of these diseases may affect small numbers of people, rare diseases as a group affect almost 30 million Americans;

Whereas, many rare diseases are serious and debilitating conditions that have a significant impact on the lives of those affected;

Whereas, while more than 450 drugs and biologics have been approved for the treatment of rare diseases according to the Food and Drug Administration (FDA), millions of Americans still have rare diseases for which there is no approved treatment;

Whereas, individuals and families affected by rare diseases often experience problems such as diagnosis delay, difficulty finding a medical expert, and lack of access to treatments or ancillary services;

Whereas, while the public is familiar with some rare diseases such as “Lou Gehrig’s disease” and sympathetic to those affected, many patients and families affected by less widely known rare diseases like Kennedy’s Disease bear a large share of the burden of funding research and raising public awareness to support the search for treatments;

Whereas, hundreds of residents of Contra Costa County are among those affected by rare diseases since nearly one in 10 Americans have rare diseases;

Whereas, the National Organization for Rare Disorders (NORD) is organizing a nationwide observance of Rare Disease Day on February 28, 2022;

Whereas, thousands of patients and caregivers, medical professionals, researchers, companies developing orphan products to treat people with rare diseases, and others in Contra Costa County, will participate in that observance;

Therefore, be it resolved that **the last day of** February, will be observed as Rare Disease Day in the County of Contra Costa.

KAREN MITCHOFF

Chair, District IV Supervisor

JOHN GIOIA

District I Supervisor

CANDACE ANDERSEN

District II Supervisor

DIANE BURGIS

District III Supervisor

FEDERAL D. GLOVER

District V Supervisor

I hereby certify that this is a true and correct copy of an action taken and entered on the minutes of the Board of Supervisors on the date shown.

ATTESTED: March 8, 2022

Monica Nino, County Administrator

By: _____, Deputy

To: Board of Supervisors
From: John Gioia, District I Supervisor
Date: March 8, 2022



Contra
Costa
County

Subject: Recognizing March 10, 2022 as the 63rd Anniversary of the Tibetan National Uprising and Affirm Support to the People of Tibet

APPROVE

OTHER

RECOMMENDATION OF CNTY ADMINISTRATOR

RECOMMENDATION OF BOARD COMMITTEE

Action of Board On: **03/08/2022** APPROVED AS RECOMMENDED OTHER

Clerks Notes:

VOTE OF SUPERVISORS

AYE: John Gioia, District I Supervisor
Candace Andersen, District II Supervisor
Diane Burgis, District III Supervisor
Karen Mitchoff, District IV Supervisor
Federal D. Glover, District V Supervisor

I hereby certify that this is a true and correct copy of an action taken and entered on the minutes of the Board of Supervisors on the date shown.

ATTESTED: March 8, 2022

Monica Nino, County Administrator and Clerk of the Board of Supervisors

By: Antonia Welty, Deputy

Contact: James Lyons, 510-942-2222

cc:

ATTACHMENTS

Resolution

2022/80

*The Board of Supervisors of
Contra Costa County, California*

In the matter of:

Resolution No. 2022/80

RECOGNIZING MARCH 10, 2022 AS THE 63rd ANNIVERSARY OF THE TIBETAN NATIONAL UPRISING AND AFFIRM SUPPORT TO THE PEOPLE OF TIBET

WHEREAS, on March 10, 2022, Californians, including Tibetan-Americans, residing in Contra Costa County will commemorate the 63rd anniversary of the Tibetan National Uprising against the Chinese invasion and occupation of Tibet;

WHEREAS, Contra Costa County has a diverse population, including Tibetan-Americans, who are concerned about human rights and freedom in the United States and throughout the world; and the cities in Contra Costa County have a long history of support for Tibet and the Tibetan people;

WHEREAS, His Holiness the 14th Dalai Lama was awarded the Congressional Gold Medal in October 2007 in recognition of his many enduring and outstanding contributions to peace, nonviolence, human rights, and religious understanding; and visited the City of Richmond in February 2014;

WHEREAS, Tibetan-Americans have expressed concern at the Chinese Government's travel restrictions against Tibetans and U.S. citizens, restrictive regulations on religious affairs in Tibet, censorship of Buddhist literature and information in Tibet, demolition of Tibetan Buddhist sites, and imprisonment of Tibetan prisoners of conscience;

WHEREAS, Contra Costa County supports the determination of the Tibetan people in Tibet and outside Tibet, to retain their heritage and protect it from destruction through non-violent and peaceful means;

NOW, THEREFORE, BE IT RESOLVED by the Board of Supervisors that March 10, 2022 shall be officially recognized as "Tibet Day" in Contra Costa County; BE IT FURTHER RESOLVED that Contra Costa County is in solidarity with the Tibetan people and their just, peaceful and non-violent movement to remind the world of the occupation and ongoing suppression of human rights and freedom in Tibet and the continuous degradation of culture, religion, land and identity of the Tibetan people by China; BE IT FURTHER RESOLVED that copies of this resolution be sent to the President of the United States, elected federal representatives, the Governor of California, and the United Nations High Commissioner for Human Rights in Geneva, Switzerland.

KAREN MITCHOFF

Chair, District IV Supervisor

JOHN GIOIA

District I Supervisor

CANDACE ANDERSEN

District II Supervisor

DIANE BURGIS

District III Supervisor

FEDERAL D. GLOVER

District V Supervisor

I hereby certify that this is a true and correct copy of an action taken and entered on the minutes of the Board of Supervisors on the date shown.

ATTESTED: March 8, 2022

Monica Nino, County Administrator

By: _____, Deputy



Contra
Costa
County

To: Board of Supervisors
From: Brian M. Balbas, Public Works Director/Chief Engineer
Date: March 8, 2022

Subject: Recognizing Barry Schamach on his retirement and 31 years of service to Contra Costa County

APPROVE

OTHER

RECOMMENDATION OF CNTY ADMINISTRATOR

RECOMMENDATION OF BOARD COMMITTEE

Action of Board On: **03/08/2022** APPROVED AS RECOMMENDED OTHER

Clerks Notes:

VOTE OF SUPERVISORS

AYE: John Gioia, District I Supervisor
Candace Andersen, District II Supervisor
Diane Burgis, District III Supervisor
Karen Mitchoff, District IV Supervisor
Federal D. Glover, District V Supervisor

I hereby certify that this is a true and correct copy of an action taken and entered on the minutes of the Board of Supervisors on the date shown.

ATTESTED: March 8, 2022

Monica Nino, County Administrator and Clerk of the Board of Supervisors

By: Antonia Welty, Deputy

Contact: Carrie Ricci (925) 313-2235

cc:

ATTACHMENTS

Resolution No.

2022/62

*The Board of Supervisors of
Contra Costa County, California*

In the matter of:

Resolution No. 2022/62

In the matter of recognizing the contributions of Barry Schamach on his retirement and 31 years of service to Contra Costa County

WHEREAS, Barry Schamach began his career with Contra Costa County on July 16, 1990 as an Engineering Technician – Entry Level in the Engineering Services Division of the Public Works Department and was promoted to Engineering Technician – Journey Level in 1995; and

WHEREAS, Barry’s strong technical and information technology skills led to a reclassification to a Department Systems Specialist in the Information Technology Division in 1997 and was promoted to an Information Systems Programmer Analyst II in 1998; and

WHEREAS, Barry received two Awards of Excellence in 1998 for his work along with other Computer Services staff to replace over 125 computers in a short amount of time which resulted in minimal impacts to Public Works users and for bringing new Oracle applications on line; and

WHEREAS, Barry was promoted to an Information Systems Programmer Analyst IV in 1999, promoted to a Database Administrator in 2001, and promoted to an Information Systems Project Manager in 2015; and

WHEREAS, Barry has been instrumental in the project management of numerous systems during his career, including the deployment of our customer service tracking software, Maintstar, the electronic records management software, Laserfiche, project manager for implementation of the Joint Billing System timekeeping and cost recovery for land development, the Real Estate Asset Management Plan, development of Public Works first intranet page, to name a few; and

WHEREAS, Barry received the Award of Excellence in 2004 for his dedication and patience throughout the Joint Billing System project, an Award of Excellence in 2006 for presenting at the ESRI conference, an Award of Excellence in 2007 for initiating software patches to implement a new law requiring Day Light Savings Time; and in 2013 received a commendation for his work on a team to research, evaluate, procure and install business analytic software to serve as the Capital Road Improvement and Preservation Program tool; and

WHEREAS, Barry has extensive knowledge about Public Works operations, is always willing to assist wherever it’s needed, provides excellent customer service, and has a great sense of humor; and

NOW, THEREFORE, IT IS RESOLVED, that the Board of Supervisors does hereby recognize and honor Barry Schamach on his retirement and for his 31 years of dedicated service to Contra Costa County and for the high quality of work performed by him during his career. *Passed and Adopted on March 8, 2022, by a unanimous vote of the Board of Supervisors of the County of Contra Costa.*

KAREN MITCHOFF
Chair, District IV Supervisor

JOHN GIOIA
District I Supervisor

CANDACE ANDERSEN
District II Supervisor

DIANE BURGIS
District III Supervisor

FEDERAL D. GLOVER
District V Supervisor

I hereby certify that this is a true and correct copy of an action taken and entered on the minutes of the Board of Supervisors on the date shown.

ATTESTED: March 8, 2022

Monica Nino, County Administrator

By: _____, Deputy



Contra
Costa
County

To: Board of Supervisors
From: Monica Nino, County Administrator
Date: March 8, 2022

Subject: Recognizing Lisa M. Driscoll upon the occasion of her retirement

APPROVE

OTHER

RECOMMENDATION OF CNTY ADMINISTRATOR

RECOMMENDATION OF BOARD COMMITTEE

Action of Board On: **03/08/2022** APPROVED AS RECOMMENDED OTHER

Clerks Notes:

VOTE OF SUPERVISORS

AYE: John Gioia, District I Supervisor
Candace Andersen, District II Supervisor
Diane Burgis, District III Supervisor
Karen Mitchoff, District IV Supervisor
Federal D. Glover, District V Supervisor

I hereby certify that this is a true and correct copy of an action taken and entered on the minutes of the Board of Supervisors on the date shown.

ATTESTED: March 8, 2022

Monica Nino, County Administrator and Clerk of the Board of Supervisors

By: Antonia Welty, Deputy

Contact: Paula Webb 925.655.2044

cc:

ATTACHMENTS

Resolution
2022/82

*The Board of Supervisors of
Contra Costa County, California*

In the matter of:

Resolution No. 2022/82

In the Matter of recognizing Lisa M. Driscoll upon her retirement

Whereas, Lisa Driscoll has served Contra Costa County since May 24, 1984 – her career trajectory beginning as a Clerk in the Private Industry Council and continuing on to Account Clerk; then to the County Administrator’s Office as an Administrative Analyst with successive promotions to Management Analyst, Budget System Administrator and Senior Deputy County Administrator; and culminating in her appointment as County Finance Director, the position in which she has served for almost 15 years; and

Whereas, Lisa’s career has spanned working on at least 30 budget cycles, with budgets ranging from \$800 million to more than \$5 billion; and

Whereas, Lisa’s leadership as County Finance Director ensured that County departments had vital funds needed to provide critical public services to County residents; and

Whereas, Lisa, used her experience and expertise to provide outstanding service to the public with a personal commitment to integrity and honesty and with exceptional organizational abilities and dedication; and

Whereas, Lisa has been a model of reliability and expertise by having a keen understanding of the tasks assigned to her, a level of precision and thoroughness in financial calculations and a broad knowledge of public sector budgeting; and

Whereas, Lisa, after being appointed County Finance Director, guided the Board of Supervisors through a process of establishing financial policies, including the Budget Policy, Reserve Policy, Debt Management Policy and Worker’s Compensation Confidence Level Policy, each of which have contributed to the County’s excellent financial condition; and

Whereas, over Lisa’s tenure as County Finance Director, the County’s credit rating from Standard & Poor’s has increased from “AA” to “AAA” and the credit rating from Moody’s has increased from “Aa3” to “Aa1,” a sign of her expert guidance on management of the County’s finances; and

Whereas, due to Lisa’s disciplined financial management, the County ultimately achieved its goal of funding 100% of the retiree share of the County’s Other Post Employment Benefit (OPEB) liability as of June 30, 2021; and

Whereas, Lisa shepherded Contra Costa County in its quest for and receipt of 11 Distinguished Budget Presentation awards from the Government Finance Officers Association; and

Whereas, Lisa dedicated 38 years to Contra Costa County and now looks forward to spending time with family, friends, and her dog “Rollo”; and

Whereas, Lisa assures her colleagues that she will remain in touch and be a resource to them in the future. Now, therefore be it resolved that the Board of Supervisors does hereby recognize and thank Lisa M. Driscoll for more than 38 years of dedicated public service to Contra Costa County, for the high quality of contributions rendered to County residents during her tenure and congratulates her on a well-deserved retirement.

KAREN MITCHOFF

Chair, District IV Supervisor

JOHN GIOIA

District I Supervisor

CANDACE ANDERSEN

District II Supervisor

DIANE BURGIS
District III Supervisor

FEDERAL D. GLOVER
District V Supervisor

I hereby certify that this is a true and correct copy of an action taken and entered on the minutes of the Board of Supervisors on the date shown.

ATTESTED: March 8, 2022

Monica Nino, County Administrator

By: _____, Deputy



Contra
Costa
County

To: Board of Supervisors
From: Esa Ehmen-Krause, County Probation Officer
Date: March 8, 2022

Subject: Appointment to the At-Large Community Representative Seat and Community Based Organization Seat on the Juvenile Justice Coordinating Council

RECOMMENDATION(S):

APPOINT Julius VanHook to the Community Based Organization Representative Seat 1, Neil Stratton to the At-Large Seat 4 on the Juvenile Justice Coordinating Council for terms ending on June 30, 2023, as recommended by the Public Protection Committee.

FISCAL IMPACT:

No Fiscal Impact

BACKGROUND:

The Juvenile Justice Coordinating Council (JJCC) is a multiagency advisory body that informs the development and implementation of a countywide juvenile justice plan. In October 2021, staff identified that seven (7) seat appointments had expired on June 30, 2021. This created an immediate concern that the Juvenile Justice Coordinating Council JJCC would not be able to establish quorum on October 19, 2021, the Board of Supervisors approved the reappoint of the prior incumbents of the seven (7) termed seats. This was to ensure that the JJCC would be able to establish quorum and conduct meetings. The reappointment is through January 31, 2022 to allow the JJCC staff to conduct an open recruitment for these seats.

APPROVE

OTHER

RECOMMENDATION OF CNTY ADMINISTRATOR

RECOMMENDATION OF BOARD COMMITTEE

Action of Board On: **03/08/2022** APPROVED AS RECOMMENDED OTHER

Clerks Notes:

VOTE OF SUPERVISORS

AYE: John Gioia, District I Supervisor
Candace Andersen, District II Supervisor
Diane Burgis, District III Supervisor
Karen Mitchoff, District IV Supervisor
Federal D. Glover, District V Supervisor

I hereby certify that this is a true and correct copy of an action taken and entered on the minutes of the Board of Supervisors on the date shown.

ATTESTED: March 8, 2022

Monica Nino, County Administrator and Clerk of the Board of Supervisors

By: Stacey M. Boyd, Deputy

Contact: Deborah Caldwell (925)313-4188

cc:

BACKGROUND: (CONT'D)

The Probation Department issued a Press Release on February 1, 2022, to recruit for one (1) at-large representative seat and one (1) community based organization representative seat on the Juvenile Justice Coordinating Council (JJCC). Probation received a total of three (3) applications prior to the deadline. All applicants were considered and were invited to participate in public interviews scheduled for the Public Protection Committee (PPC) meeting on February 28, 2022. There were three (3) applicants in attendance at the February 28 meeting, all of whom were interviewed. Once interviews were conducted, the PPC members recommended Julius VanHook, and Neil Stratton be appointed to the JJCC by the Board of Supervisors for a term of two years ending June 30, 2023.

CONSEQUENCE OF NEGATIVE ACTION:

If this action is not approved, the Community Based Organization Representative seat and At-Large Representative seat will remain vacant and the JJCC will be unable to reach quorum.



Contra
Costa
County

To: Board of Supervisors
From: Anna Roth, Health Services
Date: March 8, 2022

Subject: Add One Mental Health Specialist II and One Mental Health Community Support Worker II Positions in the Health Services Department

RECOMMENDATION(S):

ADOPT Position Adjustment Resolution No. 25912 to add one (1) Mental Health Specialist II (VQVA) position at salary plan and grade TC2-1284 (\$4,978 - \$7,033) and one Mental Health Community Support Worker II (VQVB) position at salary plan and grade TC5-0968 (\$3,533 - \$4,295) in the Behavioral Health division of the Health Services department. (Represented)

FISCAL IMPACT:

Upon approval, this action will result in an annual cost of approximately \$242,497, with pension cost of \$94,040 already included. The positions will be 100% funded by the American Rescue Plan Act (ARPA) Community Mental Health Services Block Grant.

BACKGROUND:

Contra Costa County's First Hope Program is an outpatient treatment program that offers intensive family-centered services to adolescents and young adults showing early signs of psychosis. In order for the program to continue to thrive and provide quality service to the public, the program must add one Mental Health Specialist II and one Mental Health Community Support Worker II positions.

APPROVE

OTHER

RECOMMENDATION OF CNTY ADMINISTRATOR

RECOMMENDATION OF BOARD COMMITTEE

Action of Board On: **03/08/2022** APPROVED AS RECOMMENDED OTHER

Clerks Notes:

VOTE OF SUPERVISORS

AYE: John Gioia, District I Supervisor
Candace Andersen, District II Supervisor
Diane Burgis, District III Supervisor
Karen Mitchoff, District IV Supervisor
Federal D. Glover, District V Supervisor

I hereby certify that this is a true and correct copy of an action taken and entered on the minutes of the Board of Supervisors on the date shown.

ATTESTED: March 8, 2022

Monica Nino, County Administrator and Clerk of the Board of Supervisors

By: June McHuen, Deputy

Contact: Lauren Jimenez, (925) 957-5262

cc: Lauren Jimenez, Kathi Caudel, Cheryl Shipley, Faye Ny, Stacey Tupper

BACKGROUND: (CONT'D)

The Mental Health Specialist II will support the academic and vocational functioning by guiding clients and their families through the Individualized Educational Plan (IEP) process, connecting clients with student disability services at college, and communicating with school staff in regards to mental health symptoms. The Mental Health Community Support Worker II will provide mentorship and peer support services and assistance by providing linkage and support with community resources, co-facilitating peer and multi-family groups, transporting, and advocating for clients at appointments and meetings.

CONSEQUENCE OF NEGATIVE ACTION:

If this action is not approved, there will not be adequate staffing which will result in delayed services to the public.

AGENDA ATTACHMENTS

P300 No. 25912 HSD

MINUTES ATTACHMENTS

Signed P300 25912

POSITION ADJUSTMENT REQUEST

NO. 25912
DATE 2/14/2022

Department Health Services Department Department No./
Budget Unit No. 0467 Org No. 5895 Agency No. A18

Action Requested: Add one Mental Health Specialist II (VQVA) position and one Mental Health Community Support Worker II (VQVB) position in the Behavioral Health division of the Health Services department. (Represented)

Proposed Effective Date: 3/9/2022

Classification Questionnaire attached: Yes No / Cost is within Department's budget: Yes No

Total One-Time Costs (non-salary) associated with request: \$0.00

Estimated total cost adjustment (salary / benefits / one time):

Total annual cost \$242,497.00 Net County Cost \$0.00
Total this FY \$80,832.33 N.C.C. this FY \$0.00

SOURCE OF FUNDING TO OFFSET ADJUSTMENT 100% ARPA Community Mental Health Block Grant

Department must initiate necessary adjustment and submit to CAO.
Use additional sheet for further explanations or comments.

Lauren Jimenez

(for) Department Head

REVIEWED BY CAO AND RELEASED TO HUMAN RESOURCES DEPARTMENT

Kaitlyn Jeffus for

3/1/2022

Deputy County Administrator

Date

HUMAN RESOURCES DEPARTMENT RECOMMENDATIONS

DATE _____

Exempt from Human Resources review under delegated authority

Amend Resolution 71/17 establishing positions and resolutions allocating classes to the Basic / Exempt salary schedule.

Effective: Day following Board Action.
 _____(Date)

(for) Director of Human Resources

Date

COUNTY ADMINISTRATOR RECOMMENDATION:

DATE

3/3/2022

- Approve Recommendation of Director of Human Resources
- Disapprove Recommendation of Director of Human Resources
- Other: Approve as recommended by the department.

Enid Mendoza

(for) County Administrator

BOARD OF SUPERVISORS ACTION:

Adjustment is APPROVED DISAPPROVED

Monica Nino, Clerk of the Board of Supervisors
and County Administrator

DATE _____

BY _____

APPROVAL OF THIS ADJUSTMENT CONSTITUTES A PERSONNEL / SALARY RESOLUTION AMENDMENT

POSITION ADJUSTMENT ACTION TO BE COMPLETED BY HUMAN RESOURCES DEPARTMENT FOLLOWING BOARD ACTION

Adjust class(es) / position(s) as follows:

REQUEST FOR PROJECT POSITIONS

Department _____

Date _____

No. _____

1. Project Positions Requested:

2. Explain Specific Duties of Position(s)

3. Name / Purpose of Project and Funding Source (do not use acronyms i.e. SB40 Project or SDSS Funds)

4. Duration of the Project: Start Date _____ End Date _____
Is funding for a specified period of time (i.e. 2 years) or on a year-to-year basis? Please explain.

5. Project Annual Cost
 - a. Salary & Benefits Costs: _____
 - b. Support Costs: _____
(services, supplies, equipment, etc.)
 - c. Less revenue or expenditure: _____
 - d. Net cost to General or other fund: _____

6. Briefly explain the consequences of not filling the project position(s) in terms of:
 - a. potential future costs
 - b. legal implications
 - c. financial implications
 - d. political implications
 - e. organizational implications

7. Briefly describe the alternative approaches to delivering the services which you have considered. Indicate why these alternatives were not chosen.

8. Departments requesting new project positions must submit an updated cost benefit analysis of each project position at the halfway point of the project duration. This report is to be submitted to the Human Resources Department, which will forward the report to the Board of Supervisors. Indicate the date that your cost / benefit analysis will be submitted

9. How will the project position(s) be filled?
 - a. Competitive examination(s)
 - b. Existing employment list(s) Which one(s)? _____
 - c. Direct appointment of:
 1. Merit System employee who will be placed on leave from current job
 2. Non-County employee

Provide a justification if filling position(s) by C1 or C2

USE ADDITIONAL PAPER IF NECESSARY

POSITION ADJUSTMENT REQUEST

NO. 25912
DATE 2/14/2022

Department Health Services Department
Department No./ Budget Unit No. 0467 Org No. 5895 Agency No. A18

Action Requested: Add one Mental Health Specialist II (VQVA) position and one Mental Health Community Support Worker II (VQVB) position in the Behavioral Health division of the Health Services department. (Represented)

Proposed Effective Date: 3/9/2022

Classification Questionnaire attached: Yes [] No [X] / Cost is within Department's budget: Yes [] No [X]

Total One-Time Costs (non-salary) associated with request: \$0.00

Estimated total cost adjustment (salary / benefits / one time):

Total annual cost \$242,497.00 Net County Cost \$0.00
Total this FY \$80,832.33 N.C.C. this FY \$0.00

SOURCE OF FUNDING TO OFFSET ADJUSTMENT 100% ARPA Community Mental Health Block Grant

Department must initiate necessary adjustment and submit to CAO.
Use additional sheet for further explanations or comments.

Lauren Jimenez

(for) Department Head

REVIEWED BY CAO AND RELEASED TO HUMAN RESOURCES DEPARTMENT

Kaitlyn Jeffus for

3/1/2022

Deputy County Administrator

Date

HUMAN RESOURCES DEPARTMENT RECOMMENDATIONS

DATE

Exempt from Human Resources review under delegated authority

Amend Resolution 71/17 establishing positions and resolutions allocating classes to the Basic / Exempt salary schedule.

Effective: [X] Day following Board Action.
[] (Date)

(for) Director of Human Resources

Date

COUNTY ADMINISTRATOR RECOMMENDATION:

DATE

3/3/2022

- [] Approve Recommendation of Director of Human Resources
[] Disapprove Recommendation of Director of Human Resources
[X] Other: Approve as recommended by the department.

Enid Mendoza

(for) County Administrator

BOARD OF SUPERVISORS ACTION:

Adjustment is APPROVED [X] DISAPPROVED []

Monica Nino, Clerk of the Board of Supervisors and County Administrator

DATE 03-08-2022

BY

APPROVAL OF THIS ADJUSTMENT CONSTITUTES A PERSONNEL / SALARY RESOLUTION AMENDMENT

POSITION ADJUSTMENT ACTION TO BE COMPLETED BY HUMAN RESOURCES DEPARTMENT FOLLOWING BOARD ACTION

Adjust class(es) / position(s) as follows:



Contra
Costa
County

To: Board of Supervisors
From: Anna Roth, Health Services
Date: March 8, 2022

Subject: Increase the Hours of One Registered Dental Assistant in the Health Services Department

RECOMMENDATION(S):

ADOPT Position Adjustment Resolution No. 25913 to increase the hours of one part-time Registered Dental Assistant (V9WG) position #7829 at salary plan and grade TA5-1085 (\$3,967 - \$4,822) from 32/40 to 40/40 in the Health Services Department. (Represented)

FISCAL IMPACT:

Upon approval, this action will result in an annual cost of approximately \$17,601, with \$6,826 in pension cost already included. (100% Hospital Enterprise Fund I)

BACKGROUND:

The incumbent of Registered Dental Assistant position #7829 has been working full-time on a consistent basis and is requesting to formally increase their hours from 32/40 to 40/40. Per MOU, incumbents may request to increase or decrease their hours; depending on departmental needs, the manager will evaluate whether the request can be approved. The manager over this position has determined that this change would be beneficial in helping the department meet operational needs.

CONSEQUENCE OF NEGATIVE ACTION:

If this action is not approved, the department will not be able to fulfill the request of the incumbent.

APPROVE

OTHER

RECOMMENDATION OF CNTY ADMINISTRATOR

RECOMMENDATION OF BOARD COMMITTEE

Action of Board On: **03/08/2022** APPROVED AS RECOMMENDED OTHER

Clerks Notes:

VOTE OF SUPERVISORS

AYE: John Gioia, District I Supervisor
Candace Andersen, District II Supervisor
Diane Burgis, District III Supervisor
Karen Mitchoff, District IV Supervisor
Federal D. Glover, District V Supervisor

I hereby certify that this is a true and correct copy of an action taken and entered on the minutes of the Board of Supervisors on the date shown.

ATTESTED: March 8, 2022

Monica Nino, County Administrator and Clerk of the Board of Supervisors

By: June McHuen, Deputy

Contact: Cheryl Standley, (925) 370-5271

cc: Jo-Anne Linares, Lauren Ludwig, Cheryl Standley

AGENDA

ATTACHMENTS

P300 No. 25913 HSD

MINUTES

ATTACHMENTS

Signed P300 25913

POSITION ADJUSTMENT REQUEST

NO. 25913
DATE 2/22/2022

Department Health Services

Department No./
Budget Unit No. 0540 Org No. 6375 Agency No. A18

Action Requested: Increase the hours of one Registered Dental Assistant (V9WG) position #7829 from 32/40 to 40/40 in the Health Services Department. (Represented)

Proposed Effective Date: 3/9/2022

Classification Questionnaire attached: Yes No / Cost is within Department's budget: Yes No

Total One-Time Costs (non-salary) associated with request: \$0.00

Estimated total cost adjustment (salary / benefits / one time):

Total annual cost \$17,601.16 Net County Cost \$17,601.16
Total this FY \$5,867.05 N.C.C. this FY \$5,867.05

SOURCE OF FUNDING TO OFFSET ADJUSTMENT 100% Hospital Enterprise Fund I

Department must initiate necessary adjustment and submit to CAO.
Use additional sheet for further explanations or comments.

Lauren Ludwig

(for) Department Head

REVIEWED BY CAO AND RELEASED TO HUMAN RESOURCES DEPARTMENT

Kaitlyn Jeffus for

3/1/2022

Deputy County Administrator

Date

HUMAN RESOURCES DEPARTMENT RECOMMENDATIONS

DATE _____

Exempt from Human Resources review under delegated authority

Amend Resolution 71/17 establishing positions and resolutions allocating classes to the Basic / Exempt salary schedule.

Effective: Day following Board Action.
 _____(Date)

(for) Director of Human Resources

Date

COUNTY ADMINISTRATOR RECOMMENDATION:

DATE

3/3/2022

- Approve Recommendation of Director of Human Resources
- Disapprove Recommendation of Director of Human Resources
- Other: Approve as recommended by the department.

Enid Mendoza

(for) County Administrator

BOARD OF SUPERVISORS ACTION:

Monica Nino, Clerk of the Board of Supervisors
and County Administrator

Adjustment is APPROVED DISAPPROVED

DATE _____

BY _____

APPROVAL OF THIS ADJUSTMENT CONSTITUTES A PERSONNEL / SALARY RESOLUTION AMENDMENT

POSITION ADJUSTMENT ACTION TO BE COMPLETED BY HUMAN RESOURCES DEPARTMENT FOLLOWING BOARD ACTION

Adjust class(es) / position(s) as follows:

REQUEST FOR PROJECT POSITIONS

Department _____

Date _____

No. _____

1. Project Positions Requested:

2. Explain Specific Duties of Position(s)

3. Name / Purpose of Project and Funding Source (do not use acronyms i.e. SB40 Project or SDSS Funds)

4. Duration of the Project: Start Date _____ End Date _____
Is funding for a specified period of time (i.e. 2 years) or on a year-to-year basis? Please explain.

5. Project Annual Cost
 - a. Salary & Benefits Costs: _____
 - b. Support Costs: _____
(services, supplies, equipment, etc.)
 - c. Less revenue or expenditure: _____
 - d. Net cost to General or other fund: _____

6. Briefly explain the consequences of not filling the project position(s) in terms of:
 - a. potential future costs
 - b. legal implications
 - c. financial implications
 - d. political implications
 - e. organizational implications

7. Briefly describe the alternative approaches to delivering the services which you have considered. Indicate why these alternatives were not chosen.

8. Departments requesting new project positions must submit an updated cost benefit analysis of each project position at the halfway point of the project duration. This report is to be submitted to the Human Resources Department, which will forward the report to the Board of Supervisors. Indicate the date that your cost / benefit analysis will be submitted

9. How will the project position(s) be filled?
 - a. Competitive examination(s)
 - b. Existing employment list(s) Which one(s)? _____
 - c. Direct appointment of:
 1. Merit System employee who will be placed on leave from current job
 2. Non-County employee

Provide a justification if filling position(s) by C1 or C2

USE ADDITIONAL PAPER IF NECESSARY

POSITION ADJUSTMENT REQUEST

NO. 25913
DATE 2/22/2022

Department Health Services
Department No./ Budget Unit No. 0540 Org No. 6375 Agency No. A18
Action Requested: Increase the hours of one Registered Dental Assistant (V9WG) position #7829 from 32/40 to 40/40 in the Health Services Department. (Represented)

Proposed Effective Date: 3/9/2022

Classification Questionnaire attached: Yes [] No [X] / Cost is within Department's budget: Yes [] No [X]

Total One-Time Costs (non-salary) associated with request: \$0.00

Estimated total cost adjustment (salary / benefits / one time):

Total annual cost \$17,601.16 Net County Cost \$17,601.16

Total this FY \$5,867.05 N.C.C. this FY \$5,867.05

SOURCE OF FUNDING TO OFFSET ADJUSTMENT 100% Hospital Enterprise Fund I

Department must initiate necessary adjustment and submit to CAO. Use additional sheet for further explanations or comments.

Lauren Ludwig

(for) Department Head

REVIEWED BY CAO AND RELEASED TO HUMAN RESOURCES DEPARTMENT

Kaitlyn Jeffus for

3/1/2022

Deputy County Administrator

Date

HUMAN RESOURCES DEPARTMENT RECOMMENDATIONS

DATE

Exempt from Human Resources review under delegated authority

Amend Resolution 71/17 establishing positions and resolutions allocating classes to the Basic / Exempt salary schedule.

Effective: [X] Day following Board Action.

[X] XXXXX (Date) XXXXX

(for) Director of Human Resources

Date

COUNTY ADMINISTRATOR RECOMMENDATION:

DATE

3/3/2022

- [] Approve Recommendation of Director of Human Resources
[] Disapprove Recommendation of Director of Human Resources
[X] Other: Approve as recommended by the department.

Enid Mendoza

(for) County Administrator

BOARD OF SUPERVISORS ACTION:

Adjustment is APPROVED [X] DISAPPROVED [X]

Monica Nino, Clerk of the Board of Supervisors and County Administrator

DATE 03-08-2022

BY [Signature]

APPROVAL OF THIS ADJUSTMENT CONSTITUTES A PERSONNEL / SALARY RESOLUTION AMENDMENT

POSITION ADJUSTMENT ACTION TO BE COMPLETED BY HUMAN RESOURCES DEPARTMENT FOLLOWING BOARD ACTION

Adjust class(es) / position(s) as follows:



Contra
Costa
County

To: Board of Supervisors
From: Anna Roth, Health Services
Date: March 8, 2022

Subject: Decrease the Hours of 2 Pediatrician-Ambulatory-Exempt Positions and Increase the Hours of 1 Pediatrician-Ambulatory-Exempt Position

RECOMMENDATION(S):

ADOPT Position Adjustment Resolution No. 25914 to decrease the hours of two (2) Pediatrician-Ambulatory-Exempt (VPS9) positions #7305 from 31/40 to 26/40 (Brentwood Health Center - org 6390), and #13802 from 40/40 to 22/40 (Antioch Health Center - org 6410), at salary plan and grade 1PX-1009 (\$17,348 - \$19,854); and to increase the hours of one (1) vacant Pediatrician-Ambulatory-Exempt (VPS9) position #15668 from 33/40 to 35/40 (West County Health Center - org 6384) at salary plan and grade 1PX-1009 (\$17,348 - \$19,854) in the Health Services Department. (Represented)

FISCAL IMPACT:

Upon approval, this action will result in an overall annual cost savings of approximately \$190,225, with \$73,769 in pension cost already included to the Hospital Enterprise Fund I.

BACKGROUND:

Incumbents in this classification have the ability to request that their position hours be increased or decreased, as outlined in their MOU. Managers evaluate these requests to determine whether the change will negatively impact divisional operations. The incumbent of position

APPROVE

OTHER

RECOMMENDATION OF CNTY ADMINISTRATOR

RECOMMENDATION OF BOARD COMMITTEE

Action of Board On: **03/08/2022** APPROVED AS RECOMMENDED OTHER

Clerks Notes:

VOTE OF SUPERVISORS

AYE: John Gioia, District I Supervisor
Candace Andersen, District II Supervisor
Diane Burgis, District III Supervisor
Karen Mitchoff, District IV Supervisor
Federal D. Glover, District V Supervisor

I hereby certify that this is a true and correct copy of an action taken and entered on the minutes of the Board of Supervisors on the date shown.

ATTESTED: March 8, 2022

Monica Nino, County Administrator and Clerk of the Board of Supervisors

By: June McHuen, Deputy

Contact: Gina Soleimanieh, 925-370-5182

BACKGROUND: (CONT'D)

#7305 has requested to reduce their hours from 31/40 to 26/40; and the incumbent of position #23802 has requested to reduce their hours from 40/40 to 22/40. A third, vacant position #15668, will be increased from 33/40 to 35/40 to absorb the hours lost from the two filled positions. The Medical Staffing Office has determined that with the hiring of a third Pediatrician into this vacant position, the reduction of hours as requested by the two current incumbents will have no significant impact on meeting service needs.

CONSEQUENCE OF NEGATIVE ACTION:

If this action is not approved, the department will not be able to fulfill the request of the incumbents.

AGENDA ATTACHMENTS

P300 No. 25914 HSD

MINUTES ATTACHMENTS

Signed P300 25914

POSITION ADJUSTMENT REQUEST

NO. 25914
DATE 2/25/2022

Department Health Services Department No./
Budget Unit No. 0540 Org No. Var Agency No. A18

Action Requested: Decrease the hours of two Pediatrician-Ambulatory-Exempt positions #7305 from 31/40 to 26/40 (Brentwood Health Center - org 6390), and #13802 from 40/40 to 22/40 (Antioch Health Center - org 6410); and to increase the hours of one vacant Pediatrician-Ambulatory-Exempt position #15668 from 33/40 to 35/40 (West County Health Center - org 6384) in the Health Services Department. (Represented)

Proposed Effective Date: 3/9/2022

Classification Questionnaire attached: Yes No / Cost is within Department's budget: Yes No

Total One-Time Costs (non-salary) associated with request: \$0.00

Estimated total cost adjustment (salary / benefits / one time):

Total annual cost (\$190,224.80) Net County Cost (\$190,224.80)
Total this FY (\$63,408.27) N.C.C. this FY (\$63,408.27)

SOURCE OF FUNDING TO OFFSET ADJUSTMENT Cost Savings, Hospital Enterprise Fund I

Department must initiate necessary adjustment and submit to CAO.
Use additional sheet for further explanations or comments.

Lauren Ludwig

(for) Department Head

REVIEWED BY CAO AND RELEASED TO HUMAN RESOURCES DEPARTMENT

Kaitlyn Jeffus for

3/1/2022

Deputy County Administrator

Date

HUMAN RESOURCES DEPARTMENT RECOMMENDATIONS

DATE _____

Exempt from Human Resources review under delegated authority

Amend Resolution 71/17 establishing positions and resolutions allocating classes to the Basic / Exempt salary schedule.

Effective: Day following Board Action.
 _____(Date)

(for) Director of Human Resources

Date

COUNTY ADMINISTRATOR RECOMMENDATION:

DATE

3/3/2022

- Approve Recommendation of Director of Human Resources
- Disapprove Recommendation of Director of Human Resources
- Other: Approve as recommended by the department.

Enid Mendoza

(for) County Administrator

BOARD OF SUPERVISORS ACTION:

Adjustment is APPROVED DISAPPROVED

Monica Nino, Clerk of the Board of Supervisors
and County Administrator

DATE _____

BY _____

APPROVAL OF THIS ADJUSTMENT CONSTITUTES A PERSONNEL / SALARY RESOLUTION AMENDMENT

POSITION ADJUSTMENT ACTION TO BE COMPLETED BY HUMAN RESOURCES DEPARTMENT FOLLOWING BOARD ACTION

Adjust class(es) / position(s) as follows:

REQUEST FOR PROJECT POSITIONS

Department _____

Date _____

No. _____

1. Project Positions Requested:

2. Explain Specific Duties of Position(s)

3. Name / Purpose of Project and Funding Source (do not use acronyms i.e. SB40 Project or SDSS Funds)

4. Duration of the Project: Start Date _____ End Date _____
Is funding for a specified period of time (i.e. 2 years) or on a year-to-year basis? Please explain.

5. Project Annual Cost
 - a. Salary & Benefits Costs: _____
 - b. Support Costs: _____
(services, supplies, equipment, etc.)
 - c. Less revenue or expenditure: _____
 - d. Net cost to General or other fund: _____

6. Briefly explain the consequences of not filling the project position(s) in terms of:
 - a. potential future costs
 - b. legal implications
 - c. financial implications
 - d. political implications
 - e. organizational implications

7. Briefly describe the alternative approaches to delivering the services which you have considered. Indicate why these alternatives were not chosen.

8. Departments requesting new project positions must submit an updated cost benefit analysis of each project position at the halfway point of the project duration. This report is to be submitted to the Human Resources Department, which will forward the report to the Board of Supervisors. Indicate the date that your cost / benefit analysis will be submitted

9. How will the project position(s) be filled?
 - a. Competitive examination(s)
 - b. Existing employment list(s) Which one(s)? _____
 - c. Direct appointment of:
 1. Merit System employee who will be placed on leave from current job
 2. Non-County employee

Provide a justification if filling position(s) by C1 or C2

USE ADDITIONAL PAPER IF NECESSARY

POSITION ADJUSTMENT REQUEST

NO. 25914
DATE 2/25/2022

Department Health Services
Department No./ Budget Unit No. 0540 Org No. Var Agency No. A18
Action Requested: Decrease the hours of two Pediatrician-Ambulatory-Exempt positions #7305 from 31/40 to 26/40 (Brentwood Health Center - org 6390), and #13802 from 40/40 to 22/40 (Antioch Health Center - org 6410); and to increase the hours of one vacant Pediatrician-Ambulatory-Exempt position #15668 from 33/40 to 35/40 (West County Health Center - org 6384) in the Health Services Department. (Represented)

Proposed Effective Date: 3/9/2022

Classification Questionnaire attached: Yes [] No [X] / Cost is within Department's budget: Yes [X] No []

Total One-Time Costs (non-salary) associated with request: \$0.00

Estimated total cost adjustment (salary / benefits / one time):

Total annual cost (\$190,224.80) Net County Cost (\$190,224.80)
Total this FY (\$63,408.27) N.C.C. this FY (\$63,408.27)

SOURCE OF FUNDING TO OFFSET ADJUSTMENT Cost Savings, Hospital Enterprise Fund I

Department must initiate necessary adjustment and submit to CAO.
Use additional sheet for further explanations or comments.

Lauren Ludwig

(for) Department Head

REVIEWED BY CAO AND RELEASED TO HUMAN RESOURCES DEPARTMENT

Kaitlyn Jeffus for

3/1/2022

Deputy County Administrator

Date

HUMAN RESOURCES DEPARTMENT RECOMMENDATIONS
Exempt from Human Resources review under delegated authority

DATE

Amend Resolution 71/17 establishing positions and resolutions allocating classes to the Basic / Exempt salary schedule.

Effective: [X] Day following Board Action.
[] XXXXX/Date/XXX

(for) Director of Human Resources

Date

COUNTY ADMINISTRATOR RECOMMENDATION:

DATE

3/3/2022

- [] Approve Recommendation of Director of Human Resources
[] Disapprove Recommendation of Director of Human Resources
[X] Other: Approve as recommended by the department.

Enid Mendoza

(for) County Administrator

BOARD OF SUPERVISORS ACTION:

Adjustment is APPROVED [X] DISAPPROVED [] XXX

Monica Nino, Clerk of the Board of Supervisors and County Administrator

DATE 03-08-2022

BY [Signature]

APPROVAL OF THIS ADJUSTMENT CONSTITUTES A PERSONNEL / SALARY RESOLUTION AMENDMENT

POSITION ADJUSTMENT ACTION TO BE COMPLETED BY HUMAN RESOURCES DEPARTMENT FOLLOWING BOARD ACTION
Adjust class(es) / position(s) as follows:



Contra
Costa
County

To: Board of Supervisors
From: Anna Roth, Health Services
Date: March 8, 2022

Subject: Add three positions in the Health Services Department

RECOMMENDATION(S):

ADOPT Position Adjustment Resolution No. 25915 to add one (1) Assistant Director of Safety and Performance Improvement (VWGB) position at salary plan and grade ZZX-1011 (\$13,343 - \$16,218), one (1) Associate Medical Director-Exempt (VCS4) position at salary plan and grade B85-1013 (\$20,700- \$25,161), and one (1) Chief Operating Officer-Exempt (VWD1) position at salary plan and grade B8L-2449 (\$16,241) in the Health Services Department.

FISCAL IMPACT:

Upon approval, this action will result in an approximate annual salary and benefit cost increase of \$1,105,199. The positions will be funded 100% by Public Health Workforce Development funding.

BACKGROUND:

The California Department of Public Health (CDPH) awarded Contra Costa Health Services (CCHS) \$1,910,858 on August 31, 2021, to support public health workforce development. Funding supports positions to establish, expand, train, and sustain the public health workforce to better respond to Covid-19 or other public health crisis in the future. The Assistant Director of Safety and Performance Improvement, Associate Medical Director-Exempt, and Chief Operating Officer-Exempt positions will be embedded into the Public Health department to

APPROVE

OTHER

RECOMMENDATION OF CNTY ADMINISTRATOR

RECOMMENDATION OF BOARD COMMITTEE

Action of Board On: **03/08/2022** APPROVED AS RECOMMENDED OTHER

Clerks Notes:

VOTE OF SUPERVISORS

AYE: John Gioia, District I Supervisor
Candace Andersen, District II Supervisor
Diane Burgis, District III Supervisor
Karen Mitchoff, District IV Supervisor
Federal D. Glover, District V Supervisor

I hereby certify that this is a true and correct copy of an action taken and entered on the minutes of the Board of Supervisors on the date shown.

ATTESTED: March 8, 2022

Monica Nino, County Administrator and Clerk of the Board of Supervisors

By: June McHuen, Deputy

Contact: Larita Clow, (925) 957-5244

cc: Sherry Martija, Larita Clow, Jo-Anne Linares, Cheryl Shipley, Sue Crosby

BACKGROUND: (CONT'D)

strengthen the infrastructure and to establish a more responsive and scalable department. These positions will help meet the requirements of the upcoming Public Health accreditation process and meet deliverables in areas of health metrics, community health assessment, infectious disease response, maternal and child health and clinic services.

CCHS prepared a budget and workplan which was approved by CDPH in October 2021. To meet the deliverables of the funding, CCHS is requesting to add the above positions.

CONSEQUENCE OF NEGATIVE ACTION:

If these positions are not added, CCHS will not be able to fulfill the requirements of the funder, be able to draw down the \$1,910,858 funding, nor strengthen the department's infrastructure.

AGENDA ATTACHMENTS

P300 No. 25915 HSD

MINUTES ATTACHMENTS

Signed P300 25916

POSITION ADJUSTMENT REQUEST

NO. 25915
DATE 2/23/2022

Department Health Services Department No./
Budget Unit No. 0450 Org No. 5754 Agency No. 18

Action Requested: Add one (1) permanent full-time Assistant Director of Safety and Performance Improvement (VWGB) position at salary plan and grade ZZX-1011 (\$13,343 - \$16,218), one (1) permanent full-time Associate Medical Director-Exempt (VCS4) position at salary plan and grade B85-1013 (\$20,700- \$25,161), and one (1) permanent full-time Chief Operating Officer-Exempt (VWD1) position at salary plan and grade B8L-2449 (\$16,241) in the Health Services Department.

Proposed Effective Date: 3/9/2022

Classification Questionnaire attached: Yes No / Cost is within Department's budget: Yes No

Total One-Time Costs (non-salary) associated with request: \$0.00

Estimated total cost adjustment (salary / benefits / one time):

Total annual cost \$1,105,199.13 Net County Cost \$0.00
Total this FY \$368,399.71 N.C.C. this FY \$0.00

SOURCE OF FUNDING TO OFFSET ADJUSTMENT 100% Public Health Workforce Development funding

Department must initiate necessary adjustment and submit to CAO.
Use additional sheet for further explanations or comments.

Larita Clow

(for) Department Head

REVIEWED BY CAO AND RELEASED TO HUMAN RESOURCES DEPARTMENT

Kaitlyn Jeffus for

3/1/2022

Deputy County Administrator

Date

HUMAN RESOURCES DEPARTMENT RECOMMENDATIONS

DATE _____

Exempt from Human Resources review under delegated authority.

Amend Resolution 71/17 establishing positions and resolutions allocating classes to the Basic / Exempt salary schedule.

Effective: Day following Board Action.
 _____(Date)

(for) Director of Human Resources

Date

COUNTY ADMINISTRATOR RECOMMENDATION:

DATE

3/3/2022

- Approve Recommendation of Director of Human Resources
- Disapprove Recommendation of Director of Human Resources
- Other: Approve as recommended by the department.

Enid Mendoza

(for) County Administrator

BOARD OF SUPERVISORS ACTION:

Adjustment is APPROVED DISAPPROVED

Monica Nino, Clerk of the Board of Supervisors
and County Administrator

DATE _____

BY _____

APPROVAL OF THIS ADJUSTMENT CONSTITUTES A PERSONNEL / SALARY RESOLUTION AMENDMENT

POSITION ADJUSTMENT ACTION TO BE COMPLETED BY HUMAN RESOURCES DEPARTMENT FOLLOWING BOARD ACTION

Adjust class(es) / position(s) as follows:

REQUEST FOR PROJECT POSITIONS

Department _____

Date _____

No. xxxxx

1. Project Positions Requested:

2. Explain Specific Duties of Position(s)

3. Name / Purpose of Project and Funding Source (do not use acronyms i.e. SB40 Project or SDSS Funds)

4. Duration of the Project: Start Date _____ End Date _____
Is funding for a specified period of time (i.e. 2 years) or on a year-to-year basis? Please explain.

5. Project Annual Cost
 - a. Salary & Benefits Costs: _____
 - b. Support Costs: _____
(services, supplies, equipment, etc.)
 - c. Less revenue or expenditure: _____
 - d. Net cost to General or other fund: _____

6. Briefly explain the consequences of not filling the project position(s) in terms of:
 - a. potential future costs
 - b. legal implications
 - c. financial implications
 - d. political implications
 - e. organizational implications

7. Briefly describe the alternative approaches to delivering the services which you have considered. Indicate why these alternatives were not chosen.

8. Departments requesting new project positions must submit an updated cost benefit analysis of each project position at the halfway point of the project duration. This report is to be submitted to the Human Resources Department, which will forward the report to the Board of Supervisors. Indicate the date that your cost / benefit analysis will be submitted

9. How will the project position(s) be filled?
 - a. Competitive examination(s)
 - b. Existing employment list(s) Which one(s)? _____
 - c. Direct appointment of:
 1. Merit System employee who will be placed on leave from current job
 2. Non-County employee

Provide a justification if filling position(s) by C1 or C2

USE ADDITIONAL PAPER IF NECESSARY

POSITION ADJUSTMENT REQUEST

NO. 25915
DATE 2/23/2022

Department Health Services
Department No./ Budget Unit No. 0450 Org No. 5754 Agency No. 18

Action Requested: Add one (1) permanent full-time Assistant Director of Safety and Performance Improvement (VWGB) position at salary plan and grade ZZX-1011 (\$13,343 - \$16,218), one (1) permanent full-time Associate Medical Director-Exempt (VCS4) position at salary plan and grade B85-1013 (\$20,700- \$25,161), and one (1) permanent full-time Chief Operating Officer-Exempt (VWD1) position at salary plan and grade B8L-2449 (\$16,241) in the Health Services Department.

Proposed Effective Date: 3/9/2022

Classification Questionnaire attached: Yes [] No [X] / Cost is within Department's budget: Yes [] No [X]

Total One-Time Costs (non-salary) associated with request: \$0.00

Estimated total cost adjustment (salary / benefits / one time):

Total annual cost \$1,105,199.13 Net County Cost \$0.00
Total this FY \$368,399.71 N.C.C. this FY \$0.00

SOURCE OF FUNDING TO OFFSET ADJUSTMENT 100% Public Health Workforce Development funding

Department must initiate necessary adjustment and submit to CAO.
Use additional sheet for further explanations or comments.

Larita Clow

(for) Department Head

REVIEWED BY CAO AND RELEASED TO HUMAN RESOURCES DEPARTMENT

Kaitlyn Jeffus for

3/1/2022

Deputy County Administrator

Date

HUMAN RESOURCES DEPARTMENT RECOMMENDATIONS

DATE

Exempt from Human Resources review under delegated authority.

Amend Resolution 71/17 establishing positions and resolutions allocating classes to the Basic / Exempt salary schedule.

Effective: [X] Day following Board Action.

[X] xxxxxxxx (Date) xx

(for) Director of Human Resources

Date

COUNTY ADMINISTRATOR RECOMMENDATION:

DATE

3/3/2022

- [] Approve Recommendation of Director of Human Resources
[] Disapprove Recommendation of Director of Human Resources
[X] Other: Approve as recommended by the department.

Enid Mendoza

(for) County Administrator

BOARD OF SUPERVISORS ACTION:

Monica Nino, Clerk of the Board of Supervisors and County Administrator

Adjustment is APPROVED [X] DISAPPROVED []

DATE 03-08-2022

BY

APPROVAL OF THIS ADJUSTMENT CONSTITUTES A PERSONNEL / SALARY RESOLUTION AMENDMENT

POSITION ADJUSTMENT ACTION TO BE COMPLETED BY HUMAN RESOURCES DEPARTMENT FOLLOWING BOARD ACTION

Adjust class(es) / position(s) as follows:



**Contra
Costa
County**

To: Board of Supervisors
From: Anna Roth, Health Services
Date: March 8, 2022

Subject: Add three Nutrition Assistant positions in the Health Services Department

RECOMMENDATION(S):

ADOPT Position Adjustment Resolution No. 25916 to add three (3) Nutrition Assistant (1K7B) full-time positions at salary plan and grade TC5-1086 (\$3,971 - \$4,827) in the Health Services Department. (Represented)

FISCAL IMPACT:

Upon approval, this action will result in an approximate annual cost of \$317,928, with \$123,292 in pension cost included. This cost will be 100% offset by the California Department of Public Health (CDPH) and Women, Infants and Children (WIC) program funds.

BACKGROUND:

Over the past several years, Contra Costa WIC Program’s participation rate has been increasing. Each month, the programs serve more participants than their assigned caseload. (Currently, assigned caseload is 17,150 participants per month.) The department's average participation rate is about 104% of the departments assigned caseload in 2021. The demand for WIC services continues to grow. An average of 256 unissued benefits per month has been documented between January to November of 2021. These are people who requested WIC services but

-
- APPROVE OTHER
 - RECOMMENDATION OF CNTY ADMINISTRATOR RECOMMENDATION OF BOARD COMMITTEE
-

Action of Board On: **03/08/2022** APPROVED AS RECOMMENDED OTHER

Clerks Notes:

VOTE OF SUPERVISORS

- AYE: John Gioia, District I Supervisor
 Candace Andersen, District II Supervisor
 Diane Burgis, District III Supervisor
 Karen Mitchoff, District IV Supervisor
 Federal D. Glover, District V Supervisor

I hereby certify that this is a true and correct copy of an action taken and entered on the minutes of the Board of Supervisors on the date shown.

ATTESTED: March 8, 2022

Monica Nino, County Administrator and Clerk of the Board of Supervisors

By: June McHuen, Deputy

Contact: Larita Clow, (925) 957-5244

cc: Sherry Martija, Larita Clow, Jo-Anne Linares, Cheryl Shipley

BACKGROUND: (CONT'D)

did not receive the benefits due to the program's limited staffing. CDPH WIC recognized the need for additional funding to hire more staff to serve the low-income families that qualify for WIC services. Their caseload and funding has been increased. The additional funding would allow WIC to add thee (3) additional nutrition assistant positions. The program's contract amendment documents have been approved by the state and are currently pending execution at Contracts & Grants. The Nutrition Assistants will be responsible for assisting the Public Health Nutritionists in providing nutrition and breastfeeding education to WIC participants, determining eligibility of applicants for program benefits, and participating in outreach activities.

CONSEQUENCE OF NEGATIVE ACTION:

If not approved, the department will continue to lack the proper staff to meet the current service needs of the WIC program within Health Services.

AGENDA ATTACHMENTS

P300 No. 25916 HSD

MINUTES ATTACHMENTS

Signed P300 25916

POSITION ADJUSTMENT REQUEST

NO. 25916
DATE 2/24/2022

Department Health Services Department No./
Budget Unit No. 0450 Org No. 5828 Agency No. 18
Action Requested: Add three (3) Nutrition Assistant (1K7B) full-time positions at salary plan and grade TC5-1086 (\$3,971 - \$4,827) in the Health Services Department. (Represented).

Proposed Effective Date: 3/9/2022

Classification Questionnaire attached: Yes No / Cost is within Department's budget: Yes No

Total One-Time Costs (non-salary) associated with request: \$0.00

Estimated total cost adjustment (salary / benefits / one time):

Total annual cost \$317,927.84 Net County Cost \$0.00
Total this FY \$105,975.95 N.C.C. this FY \$0.00

SOURCE OF FUNDING TO OFFSET ADJUSTMENT (100% CDPH and WIC program funds)

Department must initiate necessary adjustment and submit to CAO.
Use additional sheet for further explanations or comments.

Larita Clow

(for) Department Head

REVIEWED BY CAO AND RELEASED TO HUMAN RESOURCES DEPARTMENT

Kaitlyn Jeffus for

3/1/2022

Deputy County Administrator

Date

HUMAN RESOURCES DEPARTMENT RECOMMENDATIONS

DATE _____

Exempt from Human Resources review under delegated authority.

Amend Resolution 71/17 establishing positions and resolutions allocating classes to the Basic / Exempt salary schedule.

Effective: Day following Board Action.
 _____(Date)

(for) Director of Human Resources

Date

COUNTY ADMINISTRATOR RECOMMENDATION:

DATE

3/3/2022

- Approve Recommendation of Director of Human Resources
- Disapprove Recommendation of Director of Human Resources
- Other: Approve as recommended by the department.

Enid Mendoza

(for) County Administrator

BOARD OF SUPERVISORS ACTION:

Adjustment is APPROVED DISAPPROVED

Monica Nino, Clerk of the Board of Supervisors
and County Administrator

DATE _____

BY _____

APPROVAL OF THIS ADJUSTMENT CONSTITUTES A PERSONNEL / SALARY RESOLUTION AMENDMENT

POSITION ADJUSTMENT ACTION TO BE COMPLETED BY HUMAN RESOURCES DEPARTMENT FOLLOWING BOARD ACTION

Adjust class(es) / position(s) as follows:

REQUEST FOR PROJECT POSITIONS

Department _____

Date _____

No. xxxxx

1. Project Positions Requested:

2. Explain Specific Duties of Position(s)

3. Name / Purpose of Project and Funding Source (do not use acronyms i.e. SB40 Project or SDSS Funds)

4. Duration of the Project: Start Date _____ End Date _____
Is funding for a specified period of time (i.e. 2 years) or on a year-to-year basis? Please explain.

5. Project Annual Cost
 - a. Salary & Benefits Costs: _____
 - b. Support Costs: _____
(services, supplies, equipment, etc.)
 - c. Less revenue or expenditure: _____
 - d. Net cost to General or other fund: _____

6. Briefly explain the consequences of not filling the project position(s) in terms of:
 - a. potential future costs
 - b. legal implications
 - c. financial implications
 - d. political implications
 - e. organizational implications

7. Briefly describe the alternative approaches to delivering the services which you have considered. Indicate why these alternatives were not chosen.

8. Departments requesting new project positions must submit an updated cost benefit analysis of each project position at the halfway point of the project duration. This report is to be submitted to the Human Resources Department, which will forward the report to the Board of Supervisors. Indicate the date that your cost / benefit analysis will be submitted

9. How will the project position(s) be filled?
 - a. Competitive examination(s)
 - b. Existing employment list(s) Which one(s)? _____
 - c. Direct appointment of:
 1. Merit System employee who will be placed on leave from current job
 2. Non-County employee

Provide a justification if filling position(s) by C1 or C2

USE ADDITIONAL PAPER IF NECESSARY

POSITION ADJUSTMENT REQUEST

NO. 25916
DATE 2/24/2022

Department Health Services Department No./
Budget Unit No. 0450 Org No. 5828 Agency No. 18

Action Requested: Add three (3) Nutrition Assistant (1K7B) full-time positions at salary plan and grade TC5-1086 (\$3,971 - \$4,827) in the Health Services Department. (Represented).

Proposed Effective Date: 3/9/2022

Classification Questionnaire attached: Yes No / Cost is within Department's budget: Yes No

Total One-Time Costs (non-salary) associated with request: \$0.00

Estimated total cost adjustment (salary / benefits / one time):

Total annual cost	<u>\$317,927.84</u>	Net County Cost	<u>\$0.00</u>
Total this FY	<u>\$105,975.95</u>	N.C.C. this FY	<u>\$0.00</u>

SOURCE OF FUNDING TO OFFSET ADJUSTMENT (100% CDPH and WIC program funds)

Department must initiate necessary adjustment and submit to CAO.
Use additional sheet for further explanations or comments.

Larita Clow

(for) Department Head

REVIEWED BY CAO AND RELEASED TO HUMAN RESOURCES DEPARTMENT

Kaitlyn Jeffus for

3/1/2022

Deputy County Administrator

Date

HUMAN RESOURCES DEPARTMENT RECOMMENDATIONS

DATE _____

Exempt from Human Resources review under delegated authority.

Amend Resolution 71/17 establishing positions and resolutions allocating classes to the Basic / Exempt salary schedule.

Effective: Day following Board Action.

xxxxxxxx (Date) xxx

(for) Director of Human Resources

Date

COUNTY ADMINISTRATOR RECOMMENDATION:

DATE

3/3/2022

- Approve Recommendation of Director of Human Resources
- Disapprove Recommendation of Director of Human Resources
- Other: Approve as recommended by the department.

Enid Mendoza

(for) County Administrator

BOARD OF SUPERVISORS ACTION:

Adjustment is APPROVED ~~DISAPPROVED~~

Monica Nino, Clerk of the Board of Supervisors
and County Administrator

DATE 03-08-2022

BY 

APPROVAL OF THIS ADJUSTMENT CONSTITUTES A PERSONNEL / SALARY RESOLUTION AMENDMENT

POSITION ADJUSTMENT ACTION TO BE COMPLETED BY HUMAN RESOURCES DEPARTMENT FOLLOWING BOARD ACTION

Adjust class(es) / position(s) as follows:



Contra
Costa
County

To: Board of Supervisors
From: Brian M. Balbas, Public Works Director/Chief Engineer
Date: March 8, 2022

Subject: APPROVE and AUTHORIZE a lease amendment with Flavio Hernandez for the County-owned property located at 5830 Pacheco Boulevard, Pacheco.

RECOMMENDATION(S):

APPROVE a lease amendment with Flavio Hernandez for the drive-thru restaurant located at 5830 Pacheco Boulevard, Pacheco, to extend the term for five (5) years, through February 28, 2027. The annual rental payment for the first year is \$36,000.00 with annual increases of \$2,400.00 thereafter.

AUTHORIZE the Public Works Director, or designee, to execute the lease amendment.

FISCAL IMPACT:

The lease amendment will generate \$204,000 over the (5) five year term. 100% General Property Maintenance (General Fund).

BACKGROUND:

In 2012 the County advertised the property located at 5830 Pacheco Boulevard in Pacheco for lease and accepted lease proposals from interested parties. Mr. Hernandez’s proposal for a drive-through taqueria restaurant was the best suited for the property, and in the best interest of the County and surrounding neighborhood. Flavio Hernandez has been operating the drive through Rancho Grande Taqueria restaurant at this location since March 19, 2013. The location provides a variety of food purchase options with the convenience of a drive-through in the Pacheco area. This lease amendment provides for Flavio Hernandez’s continued occupancy of the premises.

APPROVE OTHER
 RECOMMENDATION OF CNTY ADMINISTRATOR RECOMMENDATION OF BOARD COMMITTEE

Action of Board On: **03/08/2022** APPROVED AS RECOMMENDED OTHER

Clerks Notes:

VOTE OF SUPERVISORS

AYE: John Gioia, District I Supervisor
Candace Andersen, District II Supervisor
Diane Burgis, District III Supervisor
Karen Mitchoff, District IV Supervisor
Federal D. Glover, District V Supervisor

I hereby certify that this is a true and correct copy of an action taken and entered on the minutes of the Board of Supervisors on the date shown.

ATTESTED: March 8, 2022

Monica Nino, County Administrator and Clerk of the Board of Supervisors

By: June McHuen, Deputy

Contact: Stacey Sinclair, 925. 957-2464

cc:

CONSEQUENCE OF NEGATIVE ACTION:

Not authorizing the lease renewal may result in having to find a new lessee for the property, which may result in costs to the County.

ATTACHMENTS

Lease Amendment

FIRST AMENDMENT TO LEASE

**Rancho Grande Taqueria
5830 Pacheco Blvd.
Pacheco, CA 94553**

This first amendment is dated March 1, 2022 and is between Contra Costa County, a political subdivision of the State of California (the “**County**”) and Flavio Hernandez, an individual (the “**Lessee**”).

Recitals

A. The County is the owner of the property located at 5380 Pacheco Blvd., in Pacheco, California, including the parking lot and improvements thereon (the “**Premises**”).

B. The County and the Lessee are parties to a lease dated February 27, 2013, under which the Lessee is leasing the Premises for the purpose of operating a drive through taqueria restaurant (the “**Lease**”).

C. The parties desire to extend the term of the lease through February 28, 2027 and update the contact information for the purpose of notices.

The parties therefore agree as follows:

Agreement

1. Section 2. Term is deleted in its entirety and replaced with the following:

Term. The “**Term**” of this lease begins on March 1, 2013 and ends on February 28, 2027.

2. Rent for the period of March 1, 2022 through February 28, 2027 is as follows:

<u>Period</u>	<u>Monthly Rental</u>
March 1, 2022 – February 28, 2023	\$3,000
March 1, 2023 – February 29, 2024	\$3,200
March 1, 2024 – February 28, 2025	\$3,400
March 1, 2025 – February 28, 2026	\$3,600
March 1, 2026 – February 28, 2027	\$3,800

3. Section 24. Notices is deleted in its entirety and replaced with the following:

24. Notices Any notice required or permitted under this lease shall be in writing and sent by overnight delivery service or registered or certified mail, postage prepaid and directed as follows:

To County: Contra Costa County
Public Works Department
Real Estate Division
40 Muir Road, 2nd Floor
Martinez, CA 94553
Attn: Principal Real Property Agent

To Lessee: Flavio Hernandez
2450 San Ramon Valley Blvd.
San Ramon, CA 94583

4. All other terms of the Lease remain unchanged.

[Remainder of Page Intentionally Left Blank]

Landlord and County are causing this first amendment to be executed as of the date set forth in the introductory paragraph.

COUNTY OF CONTRA COSTA, a
political subdivision of the State of
California

FLAVIO HERNANDEZ

By: _____
Brain M. Balbas
Director of Public Works

By: _____
Flavio Hernandez

RECOMMENDED FOR APPROVAL:

By: _____
Jessica L. Dillingham
Principal Real Property Agent

By: _____
Stacey Sinclair
Senior Real Property Agent

APPROVED AS TO FORM
MARY ANN MCNETT MASON,
COUNTY COUNSEL

By: _____
Kathleen M. Andrus
Deputy County Counsel



Contra
Costa
County

To: Board of Supervisors
From: Anna Roth, Health Services Director
Date: March 8, 2022

Subject: Agreement #28-983 with Public Health Foundation Enterprises, Inc. (dba Heluna Health)

RECOMMENDATION(S):

APPROVE and AUTHORIZE the Health Services Director, or designee, to execute on behalf of the County Agreement #28-983 including indemnification with Public Health Foundation Enterprises, Inc. (dba Heluna Health), a nonprofit corporation, to pay the County an amount not to exceed \$135,249 to provide Public Health Laboratory Director training and participate in the Continuity of Operations Plan (COOP) for state-wide COVID emergency testing for the period from January 1, 2021 through September 22, 2022.

FISCAL IMPACT:

The agreement will result in the County receiving an amount not to exceed \$135,249 in funding by the California Department of Public Health (CDPH) through Public Health Foundation Enterprises, Inc. No County match is required.

BACKGROUND:

This agreement will allow the County to provide Public Health Laboratory Director training fellowships to prepare fellows for national board certification exams. Fellowships will include in-person trainings in managing, supervising and administering a public health laboratory, tuition to complete academic requirements for board exams eligibility as applicable, registration, travel and lodging for national board exams, and training materials.

APPROVE

OTHER

RECOMMENDATION OF CNTY ADMINISTRATOR

RECOMMENDATION OF BOARD COMMITTEE

Action of Board On: **03/08/2022** APPROVED AS RECOMMENDED OTHER

Clerks Notes:

VOTE OF SUPERVISORS

AYE: John Gioia, District I Supervisor
Candace Andersen, District II Supervisor
Diane Burgis, District III Supervisor
Karen Mitchoff, District IV Supervisor
Federal D. Glover, District V Supervisor

I hereby certify that this is a true and correct copy of an action taken and entered on the minutes of the Board of Supervisors on the date shown.

ATTESTED: March 8, 2022

Monica Nino, County Administrator and Clerk of the Board of Supervisors

By: Laura Cassell, Deputy

Contact: Ori Tzvieli, M.D., 925-608-5267

cc: L Walker, M Wilhelm

BACKGROUND: (CONT'D)

The County will also participate in the COOP for state-wide COVID emergency testing. This includes planning meetings, capacity data, mapping to state collection sites and MOA/MOU for COVID emergency testing, verifying state collection site COVID transport media, such as Molecular Transport Medium (MTM) and/or dry swabs, testing and verifying Color Application Programming Interface (API), Laboratory Information Management System (LIMS) software integration, and completing one or more COOP exercises to test capacity to receive, test, and report state COVID specimens.

Approval of Agreement #28-983 will allow the County to receive funding to provide Public Health Laboratory Director training and participate in COOP for state-wide COVID emergency testing. This agreement includes the County agreeing to indemnify and hold harmless the contractor for claims arising out of the County's performance under this contract. The County's Public Health division received the award notification in December, therefore the request for an agreement was delayed.

CONSEQUENCE OF NEGATIVE ACTION:

If this agreement is not approved, the County will not receive funding to provide Public Health Laboratory Director Training and participate in COOP for state-wide COVID emergency testing.

ATTACHMENTS



Contra
Costa
County

To: Board of Supervisors
From: Alison McKee, County Librarian
Date: March 8, 2022

Subject: Apply for and Accept East Bay Community Foundation Grant Funds Administered by the Rodeo Municipal Advisory Council in the amount of \$5,000.

RECOMMENDATION(S):

APPROVE and AUTHORIZE the County Librarian, or designee, to apply for and accept a grant in the amount of \$5,000 from East Bay Community Foundation, administered by the Rodeo Municipal Advisory Council, for Rodeo Library services, pursuant to the local refinery Good Neighbor Agreement for the period July 1 through December 31, 2022.

FISCAL IMPACT:

No Library Fund match.

BACKGROUND:

The County currently funds 18 hours of library service at the Rodeo Library. If granted, the \$5,000 from The East Bay Community Foundation, administered by the Rodeo Municipal Advisory Council, will be used to fund additional hours of library service. The proposed additional hours will provide one extra hour of Saturday service, and three extra hours of evening service two weekdays per week. These extended hours offer Rodeo residents additional opportunities to make use of the educational and recreational resources available at the library.

CONSEQUENCE OF NEGATIVE ACTION:

If the grant proposal is not approved, the Rodeo Library will remain open for the County funded 18 hours per week, instead of the proposed 23 hours per week.

CHILDREN'S IMPACT STATEMENT:

Expanding hours at the Rodeo Library will meet all five community outcomes established in the Children's Report Card. Research shows that early and positive experiences with books set the stage for a child's success in learning to read. Additionally, literacy skills are a strong predictor of health and employment status. Expanding hours at the Rodeo Library will draw more families to the library and encourage regular exposure to reading and books, thus improving the quality of life for children and families in Rodeo.

Each impact statement would also indicate how the Board of Supervisors could judge whether this program was effective; that is, what are the expected level outcomes. As applicable, past performance indicators would also be included.

APPROVE

OTHER

RECOMMENDATION OF CNTY ADMINISTRATOR

RECOMMENDATION OF BOARD COMMITTEE

Action of Board On: **03/08/2022** APPROVED AS RECOMMENDED OTHER

Clerks Notes:

VOTE OF SUPERVISORS

AYE: John Gioia, District I Supervisor
Candace Andersen, District II Supervisor
Diane Burgis, District III Supervisor
Karen Mitchoff, District IV Supervisor
Federal D. Glover, District V Supervisor

I hereby certify that this is a true and correct copy of an action taken and entered on the minutes of the Board of Supervisors on the date shown.

ATTESTED: March 8, 2022

Monica Nino, County Administrator and Clerk of the Board of Supervisors

By: Laura Cassell, Deputy

Contact: Walt Beveridge 925-608-7730

cc:



Contra
Costa
County

To: Board of Supervisors
From: John Kopchik, Director, Conservation & Development Department
Date: March 8, 2022

Subject: Urban Tilth Park Use Agreement for Measure WW Funds

RECOMMENDATION(S):

APPROVE and AUTHORIZE the Conservation and Development Director, as fiscal agent for a portion of the East Bay Regional Park District (EBRPD) Measure WW Local Grant funds, to enter into a Park Use Agreement with Urban Tilth, a 501(c)(3) nonprofit corporation, in an amount not to exceed \$306,715 to develop the Roots and Restoration Farm at 323 Brookside Drive in North Richmond and to submit the Park Use Agreement for the Roots and Restoration Farm revised project application.

AUTHORIZE staff to apply to the East Bay Regional Park District (EBRPD) to reallocate \$16,805.12 of the \$3,046,374 of Measure WW funds awarded to the County by EBRPD to Urban Tilth's Roots and Restoration Farm.

FISCAL IMPACT:

No Impact to the General Fund. 100% of the costs will be paid by East Bay Regional Park District Measure WW Local Grant Funds.

APPROVE

OTHER

RECOMMENDATION OF CNTY ADMINISTRATOR

RECOMMENDATION OF BOARD COMMITTEE

Action of Board On: **03/08/2022** APPROVED AS RECOMMENDED OTHER

Clerks Notes:

VOTE OF SUPERVISORS

AYE: John Gioia, District I Supervisor
Candace Andersen, District II Supervisor
Diane Burgis, District III Supervisor
Karen Mitchoff, District IV Supervisor
Federal D. Glover, District V Supervisor

I hereby certify that this is a true and correct copy of an action taken and entered on the minutes of the Board of Supervisors on the date shown.

ATTESTED: March 8, 2022

Monica Nino, County Administrator and Clerk of the Board of Supervisors

By: Laura Cassell, Deputy

Contact: Kristine Solseng, (926)655-2905

cc:

BACKGROUND:

Measure WW Background

In November 2008, Alameda and Contra Costa County voters approved the East Bay Regional Park District's (EBRPD) Measure WW Regional Open Space, Wildlife, Shoreline and Parks Bond Extension. From that measure, a total of \$7.93 million is allocated for local park purposes to areas within the unincorporated area of the County. These funds were allocated to specific County Services Areas (CSA) (\$2.49 million), Community Service Districts (CSD) and local Recreation and Park Districts (\$2.39 million), and to unincorporated areas not in a CSA, CSD or local park district (\$3.05 million).

On December 15, 2015, the Board of Supervisors adopted a resolution authorizing the Department of Conservation and Development to enter into a Master Contract with EBRPD for the \$3.05 million allocated to the unincorporated areas not in a CSA, CSD, or local park district. The Master Contract between the County and EBRPD was finalized on February 1, 2016, thus allowing the County to submit individual project applications to EBRPD for funding. The portion of Measure WW Funds allocated to unincorporated communities within a CSA are administered by Public Works and covered by a separate agreement.

The Board of Supervisors approved a funding matrix at the December 15, 2015, meeting identifying individual projects to be submitted to EBRPD for funding. The project identified in Supervisorial District I was Urban Tilth's North Richmond Urban Farm Project, with an initial final allocation of \$500,000. On March 13, 2018, the Board of Supervisors recommended a revised project allocation for the Urban Tilth project of \$623,187.

On May 15, 2018, EBRPD extended the deadline for all Measure WW projects to December 31, 2021. Due to the pandemic, on May 18, 2021, East Bay Regional Park District has extended the project deadline for all projects until December 31, 2024.

Urban Tilth's North Richmond Roots and Restoration Farm Background

The Roots and Restoration Farm was established on the property at 323 Brookside Drive, Richmond, California, which was formally owned by the County and was leased to Urban Tilth for the development and ongoing operation of the North Richmond Roots and Restoration Farm. Supervisor Gioia has championed the creation and development of the North Richmond Urban Farm and the County has supported the farm's development through Park Dedication, Park Impact, and North Richmond Mitigation Fund fees totaling \$1,018,000.

On September 16, 2021, Urban Tilth purchased the property from the County and continues to develop the Farm as an agricultural park through the operation of a working farm, educational programs for the community, operation of a watershed education and training program, training of local youth in agriculture, production of honey and value-added farm products for sale, operation of a farm stand and café, associated building and facilities, and related purposes.

Proposed Park Use Agreement

The Proposed Park Use Agreement (see attached) states the Measure WW funds will be used to design, permit, and implement site preparation activities for the North Richmond Roots and Restoration Farm including, clearing the site, amending the soil, grading the site, installing hardscape, installing cultivation area, water infrastructure, and sewer infrastructure to the site. This work shall be completed in exchange for the project award.

The initial project application to East Bay Regional Park District for the Roots and Restoration project included the lease between the County and Urban Tilth to meet the required land tenure requirement. With the lease no longer applicable, the County must submit a revised application with new tenure documentation for approval. The attached Park Use Agreement meets EBRPD's land tenure requirements and outlines the responsibilities of the County and Urban Tilth for implementation of Measure WW grants. The Park Use Agreement will be effective as of September 15, 2021. Major components of the Agreement include the following:

- The project shall be open to the public,
- The agreement has a term of 25 years per EBRPD requirements,
- Urban Tilth is responsible for completing the improvements identified in the scope,
- Urban Tilth is responsible for maintenance of the site, and
- The County is responsible for grant administration.

The agreement includes the following elements

- Park Use Agreement
- Attachment A: Master Contract between East Bay Regional Park District and Contra Costa County, including amendments and extensions
- Attachment B: Project Site
- Attachment C: Service Plan
- Attachment D: Payment Request Requirements

The project was originally anticipated to be complete by December 31, 2021, however due to the pandemic and other logistical issues, the project will require additional time to be complete. The project is anticipated to be complete by the mandatory December 31, 2024, deadline.

Reallocation of Measure WW Funds

There is \$16,805.12 of Measure WW funds remaining from the Iron Horse Corridor project that has been completed. The Roots and Restoration Farm is one of two projects that has not been closed out and the only project still under construction. The County can either return the funds to East Bay Regional Park District or request they be used for the Roots and Restoration Farm.

CONSEQUENCE OF NEGATIVE ACTION:

If the contract is not extended, the planned improvements to the North Richmond Urban Farm will not be implemented.

ATTACHMENTS

Measure WW - Urban Tilth Park Use Agreement (PDF)

Exhibit A: Master Contract and Amendments (PDF)

Exhibit B: Project Site (PDF)

Exhibit C: Service Plan (PDF)

Exhibit D: Payment Request Requirements (PDF)

PARK USE AGREEMENT

Allocation of Measure WW Park Bond Funds – Roots and Restoration Agricultural Park

This park use agreement (“Agreement”) is dated September 15, 2021 (the “Effective Date”), and is between URBAN TILTH, a 510(c)(3) non-profit (“Urban Tilth”), and the COUNTY OF CONTRA COSTA, a political subdivision of the State of California (the “County”).

RECITALS

- A. In November 2008, the voters of Alameda County and Contra Costa County approved the East Bay Regional Park District’s (“EBRPD”) Measure WW Park Bond Extension (“Measure WW”). A portion of the proceeds that resulted from the issuance of the Measure WW bonds have been set aside for a local grant program, under which eligible applicants are granted Measure WW funds for eligible projects.
- B. The County and EBRPD are parties to Master Contract No. 314500 (the “Master Contract”), under which EBRPD is making a grant of Measure WW funds to the County for the acquisition and development of neighborhood, community and regional parks and recreation lands and facilities in the unincorporated area of Contra Costa County. The amount of such grant is referred to as the “Grant Proceeds.” A copy of the Master Contract is attached as Exhibit A.
- C. Following acquisition from the County on September 15, 2021, Urban Tilth now owns that certain property located at 323 Brookside Drive, Richmond, California, which is the location of the Roots and Restoration Agricultural Park (the “Project Site”). The site is approximately 3.09 acres. An aerial photograph that shows the Project Site is attached as Exhibit B.
- D. The Project Site is used as an Agricultural Park through the operation of a working farm, educational programs for the community, operation of a watershed education and training program, training of local youth in agriculture, production of honey and value-added farm products for sale, operation of a farm stand and café, associated buildings and facilities, and related purposes (together “Park Purposes”).
- E. The County desires to use a portion of the funds it received from EBRPD under the Master Contract (“Project Award”) to improve the Project Site by performing the tasks described in the Service Plan. The Service plan is attached as Exhibit C. The performance and completion of such tasks is the “Project.”

AGREEMENT

The parties therefore agree as follows:

1. Public Use of Project Site. For the Term of this Agreement, Urban Tilth shall cause the Project Site to be used for Park Purposes.

2. Term. The “Term” of this Agreement begins on and ends on the date that is twenty-five years after the date the Project is complete. If no record of the Project completion date can be found, the Term of this Agreement ends on the twenty-sixth anniversary of the Effective Date.
3. Consideration. In exchange for the Project Award, Urban Tilth shall carry out the Project as described herein.
4. Project/Use. The Project Site will be developed and used for Park Purposes. In accordance with Section B.10 of the General Provisions of the Master Contract, if the use of the Project Site changes to a use that is not for park purposes, or if the Project Site is sold or otherwise disposed of, Urban Tilth shall pay to the County the Reimbursement. The “Reimbursement” is an amount that is equals to the amount the County would be obligated to repay EBRPD pursuant to section B.10 of the General Provisions of the Master Contract. Urban Tilth shall pay the Reimbursement to the County within (30) days of a demand from the County. The County shall use the Reimbursement to either make capital improvements related to park and recreation facilities in accordance with an agreement between the County and EBRPD, or to reimburse the Project Award to EBRPD.
5. Maintenance. Urban Tilth is responsible for maintaining the Project Site. Urban Tilth’s maintenance responsibilities include, but are not limited to, weed abatement, trash collection, abatement of any illegal dumping on the Project Site, and abatement of any vandalism on the Project Site.
6. Funding Acknowledgment Sign. Urban Tilth shall post, or permit the County to post, a funding acknowledgment sign on the Project Site. The funding acknowledgment sign is to remain onsite for at least three years after completion of the improvements described on Exhibit C.
7. Nondiscrimination. In accordance with Section I of the General Provisions of the Master Contract, Urban Tilth shall not (i) discriminate against any person on the basis of sex, race, color, national origin, age, religion, ancestry, sexual orientation, or disability in the use of the Project Site during the Term, (ii) discriminate against any person on the basis of residence, except to the extent reasonable differences in admission or other fees based on residence are permitted by law.
8. Site Visits. Urban Tilth shall permit representatives of the County and representatives of EBRPD to make periodic inspections of the Project Site to determine that Urban Tilth is complying with the terms of this Agreement.
9. Notices. All notices required or permitted under this Agreement are to be in writing and delivered personally, or sent by overnight delivery service, or registered or certified mail, postage prepaid and directed as follows:

If to Urban Tilth: Doria Robinson, Executive Director
Urban Tilth
323 Brookside Drive
Richmond, CA 94801

If to County: John Kopchik, Director
The County of Contra Costa
Department of Conservation and Development
30 Muir Road
Martinez, CA 94553

Either party may, at any time or from time to time, designate in writing a substitute address for that above set forth, and thereafter notices are to be delivered to such substitute address for that above set forth. Notices to either party are effective on the date of delivery, if delivered personally, on the next business day if sent by overnight courier, and three business days after depositing in the United States Postal system if sent via registered or certified mail.

10. Project Administration. Urban Tilth shall cooperate with the County in preparing any cost reimbursement requests consistent with Measure WW requirements, including required forms and back up documentation (Exhibit D) and any Project Status Reports required by EBRPD during the Term of this Agreement.
11. Project Termination. If any portion of the grant being made to the County under the Master Contract that is intended to be used for the Project is terminated for any reason, the County has no obligation to provide that portion of the Project Award to Urban Tilth..
12. No Third-Party Beneficiaries. Nothing in this Agreement, express or implied, is intended to or does confer upon any other person any right, benefit or remedy of any nature whatsoever under or by reason of this Agreement.
13. Governing Law. The laws of the State of California govern all matters between the parties that relate to this Agreement.

The parties are signing this agreement as of the Effective Date.

COUNTY

COUNTY OF CONTRA COSTA, a political subdivision of the State of California

By: _____
John Kopchik
Director of Conservation and Development

URBAN TILTH

URBAN TILTH, A
501(C)(3) NON-PROFIT

By: _____
Doria Robinson
Urban Tilth Executive Director

**EAST BAY REGIONAL PARK DISTRICT
MEASURE WW PARK BOND
MASTER CONTRACT - LOCAL GRANT PROGRAM**

MASTER CONTRACT No.: 314500

GRANTEE: Contra Costa County

THE PROJECT PERFORMANCE PERIOD is from the date this agreement is signed below by the District through December 31, 2018

The Grantee agrees to the terms and conditions of this Contract, and the East Bay Regional Park District, acting through its Board of Directors pursuant to the Measure WW Park Bond, agrees to fund the total Project Grant Amount indicated.

THESE FUNDS ARE FOR THE ACQUISITION AND DEVELOPMENT OF NEIGHBORHOOD, COMMUNITY, AND REGIONAL PARKS AND RECREATION LANDS AND FACILITIES.

The General Provisions, Local Grant Procedural Guide, Forms and individual Project Applications are attached hereto and made a part of and incorporated into the Contract.

The District anticipates that WW Parks Bonds in the amount of \$3,046,374.00 will be issued for project.

CONTRA COSTA COUNTY DEPARTMENT OF
CONSERVATION AND DEVELOPMENT

Grantee

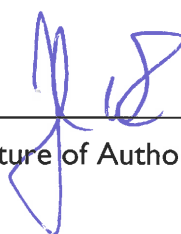
By: 
(Signature of Authorized Representative)

John Kopchik
(Print Name of Authorized Representative)

Title: Director of Conservation and Development

Date: 1-5-16

EAST BAY REGIONAL PARK DISTRICT

By: 
(Signature of Authorized Representative)

Robert E. Doyle
(Print Name of Authorized Representative)

Title: General Manager

Date: 2/1/14

Approved as to Form:

District Counsel, EBRPD

General Provisions

A. Definitions

1. The term "Measure" as used herein refers to the revenue generated from the sale of bonds for the Program.
2. The term "Application" as used herein refers to the individual Project Application(s) and its required attachments for grants, pursuant to the enabling legislation and/or procedural guidelines.
3. Acquisition: means to obtain fee title or permanent easement for public access rights in real property.
4. The term "District" means the East Bay Regional Park District.
5. The term "Development" means improvements to real property for parks and recreation purposes, including but not limited to construction of new facilities, renovation or additions to existing facilities or historic preservation and protection. WW Local Grant Program funds may only be used for Capital Improvement.
6. The term "Grantee" as used herein means the party described as the Grantee on page 1 of this Contract. The term "Project" as used herein means the project described in the Brief Description of Project on the Project Application form.

B. Project Execution

1. Subject to the availability of grant monies in the Measure, the District hereby grants to the Grantee a sum of money (grant monies) not to exceed the amount stated on page 1, in consideration of, and on condition that, the sum be expended in carrying out the purposes as set forth in the Measure WW Park Bond Local Grant Procedural Guide, and under the terms and conditions set forth in this Contract.

The Grantee shall assume any obligation to furnish any additional funds that may be necessary to complete the Project. Any modification or alteration in the Project as set forth in the Application on file with the District must be submitted to the District for approval.
2. The Grantee shall complete the Project in accordance within the time of Project Performance set forth on page 1, and under the terms and conditions of this Contract.
3. The Grantee shall certify its compliance as lead agency with the California Environmental Quality Act (Public Resources Code, Section 21000, et seq., Title 14, California Code of Regulations, Section 15000 et seq.).
4. The Grantee shall comply with all applicable current laws and regulations affecting Development Projects, including, but not limited to, legal requirements for construction Contracts, building codes, health and safety codes, and laws and codes pertaining to individuals with disabilities.

5. The Grantee shall permit periodic site visits, including a final inspection upon Project completion by the District, to determine if Development work is in accordance with the approved Project Scope.
6. Prior to the commencement of any work, the Grantee agrees to submit any significant deviation from the original scope of work in writing to the District.
7. If the Project includes Acquisition of real property, the Grantee agrees to comply with all applicable state and local laws or ordinances affecting relocation and real property acquisition.
8. The Grantee shall provide public access to Project facilities commensurate with the intent of the Project.
9. Grantees shall have (1) fee title, (2) lease hold or (3) other interest to the Project lands and demonstrate to the satisfaction of the District that the proposed Project will provide public benefits that are commensurate with the type and duration of the interest in land that is held by the Grantee, as determined by the District.
10. The Grantee shall maintain and operate the property for a period that is commensurate with the type of Project and the proportion of District funds allocated to the capital costs of the Project. With the approval of the District, the Grantee, or the Grantee's successor in interest in the property, may transfer the responsibility to maintain and operate the property in accordance with this section. The Grantee shall use the property only for the purposes for which the grant was made and shall make no other use, sale or other disposition of the property, except as authorized by specific action of the District Board of Directors. The agreements specified in this section shall not prevent the transfer of the property from the Grantee to a public agency, if the successor public agency assumes the obligations imposed by those agreements. If the use of the property or portion of the property is changed to a use that is not for parks and recreation, or if the property is sold or otherwise disposed of, an amount equal to (1) the amount of the grant, (2) the fair market value of the real property, or (3) the proceeds from the sale or other disposition, whichever is greater, shall be used by the Grantee for a parks and recreation capital purpose, pursuant to agreement with the District as specified in this section, or shall be reimbursed to the District and be available for appropriation by the District Board of Directors only for an authorized purpose.
11. The Grantee shall post and maintain a funding acknowledgement sign at the Project site for three years following receipt of final payment for the project.

C. Project Costs

1. The District may disburse to the Grantee the grant monies as follows, but not to exceed in any event, the total Grant Amount set forth of page 1 of this Contract:
 - a. The Grantee may request progress payments up to a total of up to 80% of the approved Project Application amount for eligible expenditures made on the project.
 - b. The remaining grant funds shall be paid up to the amount of the Application or the actual Project cost, whichever is less, on completion of the Project and receipt of a Completion Package of Project costs from the Grantee.

D. Project Administration

1. The Grantee shall submit written Project Status Reports to the District every six months. The District shall withhold all payments until all Project Status Reports are properly submitted.
2. The Grantee shall make property and facilities developed pursuant to this Contract available for inspection upon request by the District.

E. Project Termination

1. Any Grant funds that have not been expended by the Grantee prior to the end of the performance period set forth on page I of this Contract shall revert to the District and be available for Appropriation by the District Board of Directors for one or more other projects for parks and recreation purposes.
2. The Grantee may unilaterally rescind this Contract at any time prior to the commencement of a Project. After Project commencement, this Contract may be rescinded, modified or amended only by mutual agreement in writing between the Grantee and the District.
3. Failure by the Grantee to comply with the terms of this Contract or any other Contract under the Bond Measure may be cause for suspension of all obligations of the District hereunder. However, such failure shall not be cause for the suspension of all obligations of the District hereunder if in the judgment of the District such failure was due to no fault of the Grantee. In such case, any amount required to settle at minimum cost any irrevocable obligations properly incurred shall be eligible for reimbursement under this Contract.

F. Hold Harmless

1. The Grantee shall waive all claims and recourse against the District including the right to contribution for loss or damage to persons or property arising from, growing out of or in any way connected with or incident to this Contract except claims arising from the concurrent or sole negligence of the District, its officers, agents, and employees.
2. The Grantee shall indemnify, hold harmless and defend the District, its officers, agents and employees against any and all claims, demands, damages, costs, expenses or liability costs arising out of the Acquisition, Development, construction, operation or maintenance of the property described as the Project. This includes claims, demands or causes of action that arise under Government Code Section 895.2 or otherwise, except for liability arising out of the concurrent or sole negligence of the District, its officers, agents, or employees.
3. The Grantee agrees that in the event the District is named as codefendant under the provisions of Government Code Section 895 et seq., the Grantee shall notify the District of such fact and shall represent the District in the legal action, unless the District undertakes to represent itself as codefendant in such legal action, in which event the District shall bear its own litigation costs, expenses, and attorney's fees.
4. The Grantee and the District agree that in the event of judgment entered against the District and the Grantee because of the concurrent negligence of the District and the Grantee, their

officers, agents, or employees, an apportionment of liability to pay such judgment shall be made by a court of competent jurisdiction. Neither party shall request a jury apportionment.

5. The Grantee shall indemnify, hold harmless and defend the District, its officers, agents and employees against any and all claims, demands, costs, expenses or liability costs arising out of legal actions pursuant to items to which the Grantee has certified. The Grantee acknowledges that it is solely responsible for compliance with items to which it has certified.

G. Financial Records

1. The Grantee shall maintain satisfactory financial accounts, documents and records for the Project and make them available to the District for auditing at reasonable times. The Grantee also agrees to retain such financial accounts, documents and records until December 31, 2021.

The Grantee and the District agree that during regular office hours each of the parties hereto and their duly authorized representatives shall have the right to inspect and make copies of any books, records or reports of the other party pertaining to this Contract or matters related thereto. The Grantee shall maintain and make available for inspection by the District accurate records of all of its costs, disbursements and receipts with respect to its activities under this Contract.

2. The Grantee shall use a generally accepted accounting system.

H. Use of Facilities

1. The Grantee agrees that the Grantee shall use the property developed with grant monies under this Contract only for the purposes for which the District grant monies were requested and no other use of the area shall be permitted except by specific written approval by the District.
2. The Grantee shall maintain and operate the property developed for 25 years after final payment of grant funds. The Grantee shall permit periodic inspection of the project by the District during this period and may be required to submit annual project status reports if requested by the District.

I. Nondiscrimination

1. The Grantee shall not discriminate against any person on the basis of sex, race, color, national origin, age, religion, ancestry, sexual orientation, or disability in the use of any property or facility developed pursuant to this Contract.
2. The Grantee shall not discriminate against any person on the basis of residence except to the extent those reasonable differences in admission or other fees may be maintained on the basis of residence and pursuant to law.

J. Procedural Guidelines and Application Incorporation

The Project Application, Procedural Guidelines and Forms and any subsequent change or addition approved by the District is hereby incorporated in this Contract as though set forth in full in this Contract.

K. Severability

If any provision of this Contract or the application thereof is held invalid, that invalidity shall not affect other provisions of the Contract, which can be given effect without the invalid provision or application, and to this end the provisions of this Contract are severable.

**AMENDMENT
TO
EAST BAY REGIONAL PARK DISTRICT
MEASURE WW PARK BOND
MASTER CONTRACT – LOCAL GRANT PROGRAM**

MASTER CONTRACT No.: 314500

GRANTEE: Contra Costa County

The East Bay Regional Park District (“District”) and Contra Costa County (“Grantee”), hereby amend the Master Contract – Local Grant Program dated February 1, 2016 as follows:

- I. The Section B (Project Execution), paragraph 10 and Section H (Use of Facilities), paragraph 2 shall be amended as follows:

Section B (Project Execution), paragraph 10

The Grantee shall maintain and operate the property for a period that is commensurate with the type of Project and the proportion of District funds allocated to the capital costs of the Project. With the approval of the District, the Grantee, or the Grantee's successor in interest in the property, may transfer the responsibility to maintain and operate the property in accordance with this section. The Grantee shall use the property only for the purposes for which the grant was made and shall make no other use, sale or other disposition of the property, except as authorized by specific action of the District Board of Directors. The agreements specified in this section shall not prevent the transfer of the property from the Grantee to a public agency, if the successor public agency assumes the obligations imposed by those agreements.

For Acquisition Projects, if the use of the property or portion of the property is changed to a use that is not for parks and recreation, or if the property is sold or otherwise disposed of, the Grantee shall either reimburse to the District, or apply to parks and recreation capital purpose (pursuant to agreement with the District as specified in this section), an amount equal to (1) the amount of the grant, (2) the fair market value of the real property, or (3) the proceeds from the sale or other disposition, whichever is greater. If funds are reimbursed to the District, such reimbursement will be available for appropriation by the District Board of Directors only for an authorized purpose.

For Development Projects, if the use of the property or portion of the property is changed to a use that is not for parks and recreation, the Grantee shall reimburse to the District an amount equal to (1) the amount of the grant, less (2) a credit based on straight depreciation for time, i.e. a percentage for each year of use. Such

reimbursement to the District will be available for appropriation by the District Board of Directors only for an authorized purpose.

Notwithstanding the above, in the event of an Extraordinary Circumstance, the Grantee shall be excused from performance hereunder during the time and to the extent that the public is prevented from using the property for community park and recreation purposes, including but not limited to, payment of the amount of the grant, fair market value of the real property, or proceeds from the sale or other disposition, whichever is greater. "Extraordinary Circumstance" is an occurrence that is beyond the control of the Grantee and could not have been avoided by exercising reasonable diligence, including without limitation, any act of God; national emergency; riot; war; terrorism; governmental act or direction; change in Laws; earthquake; storm; hurricane; flood, fire, or other natural disaster; or school closure for any reason.

Section H (Use of Facilities), paragraph 2

The Grantee shall maintain and operate the property developed for a minimum of 25 years after final payment of grant funds. The Grantee shall permit periodic inspection of the project by the District during this period and may be required to submit annual project status reports if requested by the District.

2. The contract amount will remain the same.
3. All other terms and conditions of the contract will remain in full force and effect.

CONTRA COSTA COUNTY DEPARTMENT OF
CONSERVATION AND DEVELOPMENT

EAST BAY REGIONAL PARK DISTRICT

Grantee

By: 
(Signature of Authorized Representative)

John Kopchik
(Print Name of Authorized Representative)

Title: Director of Conservation and Development

Date: March 7, 2017

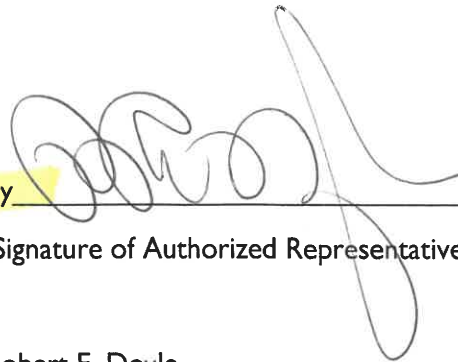
By: 
(Signature of Authorized Representative)

Robert E. Doyle
(Print Name of Authorized Representative)

Title: General Manager

Date: 3/14/17

APPROVED AS TO FORM:

By: Kristina Kelch
District Counsel

Date: 2/4/17

EAST BAY REGIONAL PARK DISTRICT

RESOLUTION NO.: 2021 – 05 - 136

May 18, 2021

AUTHORIZATION TO AMEND THE 2021 BUDGET, APPROPRIATE FUNDS, APPROVE TIME EXTENSION AND CLOSE MEASURE WW LOCAL GRANT PROGRAM PROJECTS

WHEREAS, on November 4, 2008, the voters in Alameda and Contra Costa counties approved Measure WW: Regional Open Space Wildlife, Shoreline and Parks Bond Extension; and

WHEREAS, of the \$500 million bond extension, \$125 million (25%) of the bond proceeds are allocated to the Local Grant Program to fund park and recreation projects of cities and other local communities; and

WHEREAS, on January 13, 2009 (Resolution 2009-1-011), the Board of Directors approved the Measure WW Local Grant Program Procedural Guidelines; and

WHEREAS, on January 13, 2009, (Resolution 2009-1-016) the Board of Directors approved a resolution of intention which authorizes the reimbursement of expenditures, including such incurred pursuant to the establishment of the Measure WW Local Grant program, from future bond proceeds; and

WHEREAS, on May 15, 2018, (Resolution 2018-05-116), the Board of Directors approved a resolution to extend the expiration of the WW Local Grant Program for three years, to December 31, 2021; and

WHEREAS, the Park District received one (1) project applications from City of Hercules prior to the March 31, 2021 application deadline; and

WHEREAS, staff has reviewed the application and recommends the appropriation of \$60,324.12 to fund the project and recommends budget increases for two (2) projects valued at \$45,621.86 in 2021 Measure WW Local Grant Funds; and

WHEREAS, local agencies have completed ten (10) Measure WW Local Grant Program projects;

WHEREAS, the Park District has received three written time extension requests and additional agencies may require more time to complete project.

NOW, THEREFORE, BE IT RESOLVED that the Board of Directors of the East Bay Regional Park District hereby:

1. Appropriates \$105,945.98 for Measure WW grants to other agencies, in various project budgets as described in Attachment I, brings the total appropriation of Measure WW Local Grant funds to \$123,364,702.34; and

2. Formally closes ten (10) Measure WW Local Grant Program projects as described in Attachment 2; and
3. Authorizes the adjustment of budgets and transfer of funds between WW Local Grant projects accounts within the total amount granted each agency and within the total appropriation authorized by this resolution, without additional approval from this Board; and
4. Extends the expiration of the WW Local Grant Program for three years, to December 31, 2024.

BE IT FURTHER RESOLVED that the General Manager is hereby authorized and directed on behalf of the Park District and in its name, to execute and deliver such documents and to do such acts as may be deemed necessary to accomplish the intentions of this resolution.

Moved by Director Lane, and seconded by Director Wieskamp, and adopted this 18th day of May 2021, by the following vote:

FOR: Colin Coffey, Ellen Corbett, Elizabeth Echols, Beverly Lane, Dee Rosario, Dennis Waespi, Ayn Wieskamp.

AGAINST: None.
 ABSTAIN: None.
 ABSENT: None.

Dee Rosario
 Dee Rosario
 Board President

CERTIFICATION

I, Yolande Barial Knight, Clerk of the Board of Directors of the East Bay Regional Park District, do hereby certify that the above and foregoing is a full, true and correct copy of Resolution No. 2021-05-136 adopted by the Board of Directors at a regular meeting held on May 18, 2021

Yolande Barial Knight

	A	B	C	D	E	F	G
1	Attachment I - 2021 Application Recommended to continue in the Approval Process						
2	Agency	Project Name	Project #	Fund Source		Project Amount	
3	City of Hercules	Beechnut Mini Park Renovation	312003	WL20		\$60,324.12	
4			Sub-total			\$60,324.12	
5							
6	2021 Budget Increase						
7	Agency	Project Name	Project #	Fund Source	Cuurent Amount	Budget Increase	New Amount
8	Unincorporated Alameda	Sunol Glen Playground & Outdoor Recreational Park	311303	WL03	\$420,808.00	\$9,914.00	\$430,722.00
9	City of El Cerrito	Hillside Nature Area Trail Entry and Signage Improvements Phase I	311908	WL19	\$48,000.00	\$35,707.86	\$83,707.86
10							
11			Sub-total			\$45,621.86	
12							
13		Total Appropriation				\$105,945.98	

	A	B	C	D	E
1	Attachment 2 - 2021 Measure WW Local Grant - Project Closures				
2	Agency	Project Name	Project #	Fund Source	Project Amount
3	Berkeley	Berkeley Rose Garden Renovation Phase I	310217	WL02	325,000.00
4	Fremont	California Nursery Historical Park President's House Renovation	310516	WL05	300,000.00
5	Oakland	Children's Fairyland Entryway Improvements	310707	WL07	495,771.43
6	Oakland	Golden Gate Recreation Center Expansion	310714	WL07	2,268,300.00
7	Oakland	Peralta Hacienda Park Improvements	310721	WL07	170,000.00
8	Brentwood	City-Wide Park Shade Improvements - Phase III	311509	WL15	11,845.55
9	El Cerrito	Huber Park Improvements	311903	WL19	198,292.14
10	El Cerrito	Fairmont Park Improvements Phase I	311907	WL19	359,093.48
11	Lafayette	Lafayette Open Space Nature Park - Purchase of APN 239-100-001	312105	WL21	149,600.30
12	Unincorporated Contra Costa	Tice Valley Pocket Park and Pathway	314503	WL45	623,187.00
13					
14				Total	\$4,901,089.90

Exhibit B: North Richmond Root and Restoration Farm Project Site

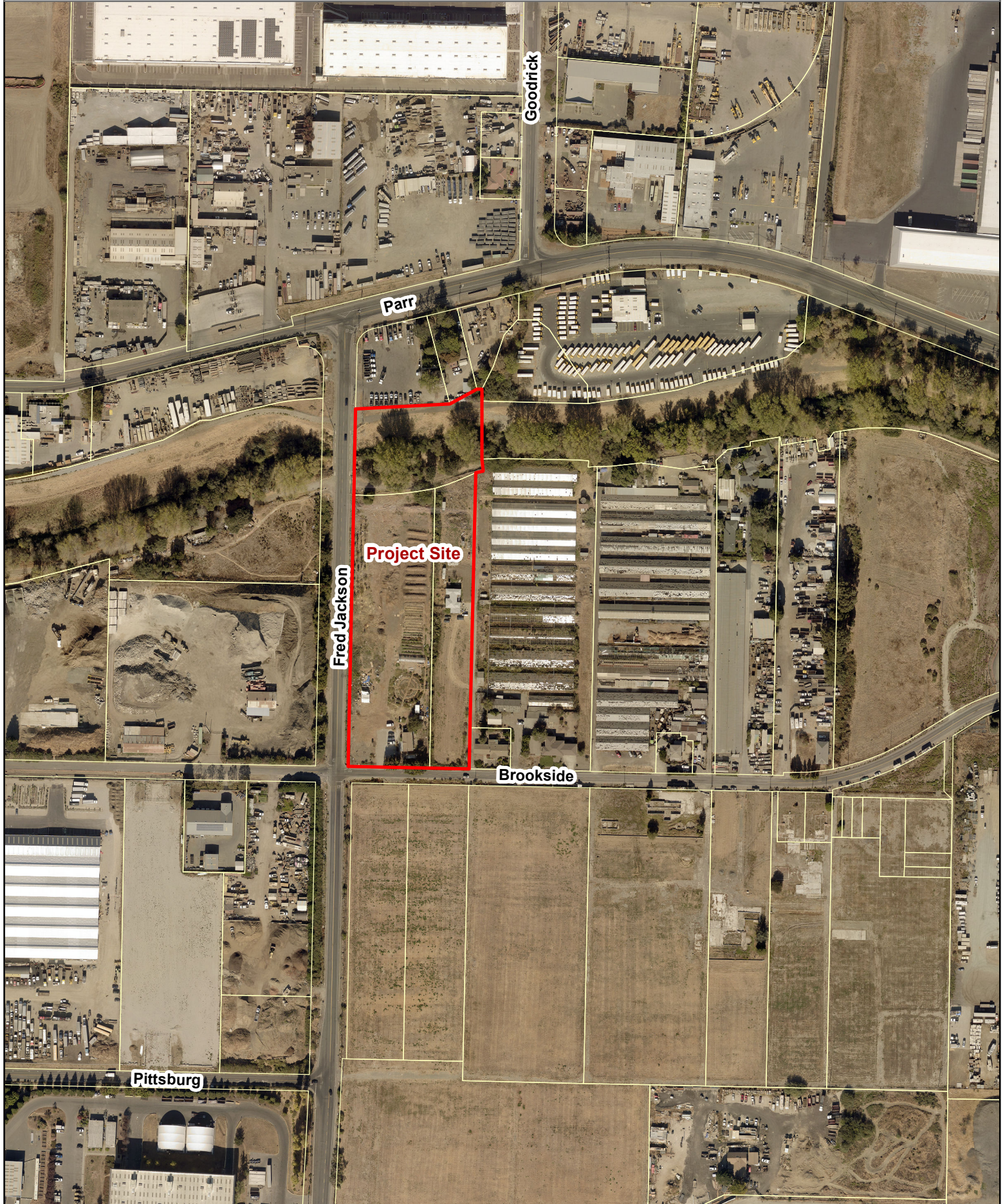

EXHIBIT C - SERVICE PLAN

Background:

In November 2008, the voters of Alameda County and Contra Costa County approved the East Bay Regional Park District’s (EBRPD) Measure WW Park Bond Extension (Measure WW). A portion of the proceeds from the issuance of the Measure WW bonds have been set aside for a local grant program, under which eligible applicants are granted Measure WW funds for eligible projects.

The County and EBRPD have entered into a Master Contract, under which EBRPD is making a grant of Measure WW funds to the County for the acquisition and development of neighborhood, community and regional parks and recreation lands and facilities in the unincorporated area of Contra Costa County. The Master Contract was amended in February 2017 to address concerns about reimbursement requirements. A copy of the Master Contract and Amendment are attached as Exhibit A.

In September 2021, Urban Tilth acquired the property at 323 Brookside Drive, Richmond, California, which is the location of the North Richmond Roots and Restoration Farm (the “Project Site”). An aerial photograph that shows the Project Site is attached as Exhibit B. The Project Site was previously leased from the County by Urban Tilth, for the purpose of developing and operating a nonprofit educational urban farm and agricultural park.

The Project Site is used as an agricultural park through the operation of a working farm, educational programs for the community, operation of a watershed education and training program, training of local youth in agriculture, production of honey and value-added farm products for sale, operation of a farm stand and café, associated buildings and facilities, and related purposes (together “Park Purposes”).

Project and Budget

Urban Tilth (“Contractor”) will design, obtain permits, and implement site preparation activities for the Roots and Restoration Farm including, clearing the site, amending the soil, grading the site, installing hardscape, installing cultivation area, water infrastructure, and sewer infrastructure to the site.

The budget for the project follows and minor amendments to the budget shall be allowed with approval of County staff, so long as it does not exceed \$306,714.77. The total contract amount combines two Measure WW allocations. The first is the current allocation for the Roots and Restoration farm (“Current Allocation”) in the amount of \$282,909.65. The second is the remaining \$16,805.12 from a completed Measure WW project and is contingent on East Bay Regional Park approval in order to be applied to the Roots and Restoration project (“Contingent Allocation”).

Current Allocation Budget

Construction Contract (Bid Item identified in Measure WW Revised Application)	\$273,800
Rough Grading: \$53,000	
Sanitary Sewer: \$198,800	
Construction Contingency: \$22,000	
Construction Support (Management, Testing, and Inspection)	\$12,109.65
Total Measure WW Funds – Current Allocation	\$289,909.65

Contingent Allocation Budget

Construction Contract (Bid Item to be identified in Measure WW Revised Application)	\$16,805.12
Rough Grading: \$8,405.56	
Sanitary Sewer: \$8,405.56	
Total Measure WW Funds – Contingent Allocation	\$16,805.12

Initials: _____

Contractor

County Dept

Payment Provisions

Contractor shall submit periodic invoices for project cost reimbursement consistent with Measure WW requirements, including required forms and backup documentation (Exhibit D). Additional EBRPD payment requirements are outlined in Exhibit A (Master Contract) Section C.

Contractor Requirements

Contractor shall ensure the terms of the Master Contract (Exhibit A) are met, in particular the following:

- All construction contracts must include prevailing wage provisions.
- The site shall be used only for the purpose the grant monies were allocated, including public access, for a period of 25 years.
- Urban Tilth shall be open to periodic monitoring of the site if requested.
- A funding acknowledgement sign shall be posted at the project site for a minimum of three years following project completion.
- Pre-Construction Costs shall not exceed 20% of the total project costs.
- Maintenance equipment and non-fixed equipment are ineligible project costs.
- Urban Tilth is responsible for the ongoing maintenance of the site.

Initials: _____

Contractor

County Dept

EXHIBIT D

East Bay Regional Park District
MEASURE WW LOCAL GRANT PROGRAM

PAYMENT REQUEST FORM

1. PROJECT TITLE	2. PROJECT NUMBER
3. APPLICANT	
4. PAYMENT REQUEST NUMBER	

5. PAYMENT INFORMATION	
a. Grant Project Amount	\$ _____
b. Funds Received To Date	\$ _____
c. Available (<i>a. minus b.</i>)	\$ <u> \$0.00 </u>
d. Amount of This Request	\$ <input type="text"/>
e. Remaining Funds After This Payment (<i>c. minus d.</i>)	\$ <u> \$0.00 </u>

6. SEND PAYMENT TO:
AGENCY NAME
STREET ADDRESS
CITY/STATE/ZIP CODE
ATTENTION

7. I represent and warrant that I have full authority to execute this payment request on behalf of the Grantee. I declare under penalty of perjury, under the laws of the State of California, that this report, and any accompanying documents, for the above-mentioned Grant is true and correct to the best of my knowledge.

CERTIFIED AND SUBMITTED BY	TITLE	DATE
▶		

FOR EAST BAY REGIONAL PARK DISTRICT USE ONLY	
PAYMENT APPROVAL	DATE
▶	

**East Bay Regional Park District
 MEASURE WW LOCAL GRANT PROGRAM
 PROJECT COSTS SUMMARY FORM**

Applicant: _____
Project Number: _____
Payment Request: _____

Project Amount: _____
Project Name: _____

Check Number	Date	Recipient	Description	Amount Construction	(Max. 20 %) Amount Pre- Construction
Subtotal				\$0.00	\$0.00
Subtotal from Labor Costs Summary Form (if applicable)				\$0.00	0
Subtotal from Equipment Costs Summary Form (if applicable)				\$0.00	0
Total				\$0.00	\$0.00
Grand Total				\$0.00	

East Bay Regional Park District
MEASURE WW LOCAL GRANT PROGRAM
IN-HOUSE EQUIPMENT COSTS SUMMARY FORM

Project Amount: _____
 Project Number: _____
 Payment Request Number: _____

Applicant: _____
 Project Name: _____

Type of Equipment	Caltrans Code	Dates Used	Hours Used	Rate	Amount Construction	Amount Pre-Construction (20% Max.)

Subtotal \$0.00 \$0.00

BACK UP DOCUMENTATION

The grantee must submit the following documents if applicable with payment requests. Items in **BOLD** maybe provided with Completion Package. In addition, an audit of the project may be performed. The grantee must retain and make available all project related records for a minimum of three years following project termination or final payment of grant funds. It is the responsibility of the grantee to have these records available in a central location ready for review once an audit date and time has been confirmed.

CONSTRUCTION CONTRACTS

- _____ Summary list of bidders (including bid advertisement date and winning bid package)
- _____ Awarding by governing body (minutes of the meeting/resolution)
- _____ Contract agreement
- _____ Contract bonds (bid, performance, payment)
- _____ Contract change orders
- _____ Contractor's invoices
- _____ Payments to contractor (cancelled checks**)
- _____ Proof of electronic funds transfer
- _____ **Final Payment to contractor** (even if paid using other funding sources)
- _____ **Stop Notices** (filed by sub-contractors and release if applicable)
- _____ **Liquidated damages** (claimed against the contractor)
- _____ **Notice of Completion or Final Acceptance**

IN-HOUSE LABOR*

- _____ Payroll records from finance system

IN-HOUSE EQUIPMENT*

- _____ Daily time records identifying the project site
- _____ Caltrans Equipment Code

MINOR CONTRACTS / MATERIALS / SERVICES / EQUIPMENT RENTALS

- _____ Purchase orders/Contracts/Service Agreements
- _____ Invoices
- _____ Payments (cancelled checks**)
- _____ The purchase of art may require an art appraisal

ACQUISITION

- _____ Appraisal Report
- _____ **Final Escrow Closing Statement**
- _____ **Cancelled checks** (payment(s) to seller(s))**
- _____ **Grant deed (vested to the participant) or final order of condemnation**
- _____ **Title insurance policy (issued to participant)**

* Estimated time expended on the projects is not acceptable. Actual time records and all supporting documentation must be maintained as charges are incurred and made available for verification at the time of audit.

** Front and back if copied.



Contra
Costa
County

To: Board of Supervisors
From: Anna Roth, Health Services Director
Date: March 8, 2022

Subject: Amendment #77-251-2 with Premier Surgery Center, L.P.

RECOMMENDATION(S):

APPROVE and AUTHORIZE the Health Services Director, or designee, to execute on behalf of the County Contract Amendment Agreement #77-251-2, with Premier Surgery Center, L.P., to amend Contract #77-251-1 effective December 1, 2021, to modify the rate schedule to include the provision of dental services for Contra Costa Health Plan (CCHP) members who are developmentally disabled adults requiring anesthesia, with no change in the payment limit of \$5,000,000 and no change in the original term of September 1, 2020 through August 31, 2022.

FISCAL IMPACT:

This amendment will result in no additional contractual service expenditures exceeding \$5,000,000. This contract is funded 100% by Contra Costa Health Plan (CCHP) Enterprise Fund II revenues. (Additional rates)

BACKGROUND:

CCHP has an obligation to provide certain specialized surgery care services for its members under the terms of their Individual and Group Health Plan membership contracts with the County. This contractor has been a part of the CCHP Provider Network since September 1, 2019.

APPROVE

OTHER

RECOMMENDATION OF CNTY ADMINISTRATOR

RECOMMENDATION OF BOARD COMMITTEE

Action of Board On: **03/08/2022** APPROVED AS RECOMMENDED OTHER

Clerks Notes:

VOTE OF SUPERVISORS

AYE: John Gioia, District I Supervisor
Candace Andersen, District II Supervisor
Diane Burgis, District III Supervisor
Karen Mitchoff, District IV Supervisor
Federal D. Glover, District V Supervisor

I hereby certify that this is a true and correct copy of an action taken and entered on the minutes of the Board of Supervisors on the date shown.

ATTESTED: March 8, 2022

Monica Nino, County Administrator and Clerk of the Board of Supervisors

By: Laura Cassell, Deputy

Contact: Sharron Mackey, 925-313-6104

cc: K Cyr, M Wilhelm

BACKGROUND: (CONT'D)

On July 28, 2020, the Board of Supervisors approved Contract #77-251-1 in the amount of \$5,000,000 for the provision of ambulatory surgery services for the period September 1, 2020 through August 31, 2022.

Approval of Contract Amendment Agreement #77-251-2 will modify the compensation schedule to include the provision of dental services for CCHP members who are developmentally disabled adults requiring anesthesia, with no change in the payment limit of \$5,000,000 through August 31, 2022. Departmental delays resulted in this contract amendment not being brought to the Board in a timely manner.

CONSEQUENCE OF NEGATIVE ACTION:

If this amendment is not approved, the contractor will not be able to provide dental operating room services for developmentally disabled CCHP members.

ATTACHMENTS



Contra
Costa
County

To: Board of Supervisors
From: Brian M. Balbas, Public Works Director/Chief Engineer
Date: March 8, 2022

Subject: APPROVE and AUTHORIZE Amendment No. 1 to Consulting Services Agreement with Hawley, Peterson & Snyder, Architects.

RECOMMENDATION(S):

APPROVE and AUTHORIZE the Public Works Director, or designee, to execute a contract amendment with Hawley, Peterson & Snyder, Architects (HPS), effective March 8, 2022, to extend the term from October 8, 2022 through October 8, 2023, and increase the payment limit by \$500,000 to a new payment limit of \$1,250,000 to provide on-call architectural services for various facilities projects.

FISCAL IMPACT:

Projects will be assigned to the on-call architect when there is an approved project and funding. (100% Various Funds)

BACKGROUND:

On October 8, 2019, the Board of Supervisors approved an as-needed Consulting Services Agreement with HPS, in the amount of \$750,000.

HPS will continue to provide typical architectural services, such as programming, design and construction administration. The type, size, and location of projects will vary. Typical projects may include new construction, building renovations/modernizations, remodeling of an entire building or specific areas within a building, tenant improvements, exterior building restorations, Mechanical-Electrical-Plumbing upgrades, structural improvements, code-related improvements and deferred maintenance projects. Project may also include fire district building projects. Extending

APPROVE

OTHER

RECOMMENDATION OF CNTY ADMINISTRATOR

RECOMMENDATION OF BOARD COMMITTEE

Action of Board On: **03/08/2022** APPROVED AS RECOMMENDED OTHER

Clerks Notes:

VOTE OF SUPERVISORS

AYE: John Gioia, District I Supervisor
Candace Andersen, District II Supervisor
Diane Burgis, District III Supervisor
Karen Mitchoff, District IV Supervisor
Federal D. Glover, District V Supervisor

I hereby certify that this is a true and correct copy of an action taken and entered on the minutes of the Board of Supervisors on the date shown.

ATTESTED: March 8, 2022

Monica Nino, County Administrator and Clerk of the Board of Supervisors

By: Laura Cassell, Deputy

Contact: Ramesh Kanzaria 925-957-2480

cc:

BACKGROUND: (CONT'D)

this as-needed agreement will save the County money when compared with the time and expense in conducting a consultant selection process on a project-by-project basis, will allow the design phase to commence sooner and provide for a shorter completion schedule.

CONSEQUENCE OF NEGATIVE ACTION:

If amendment No. 1 is not approved, projects currently in process will be delayed, which will ultimately result in higher project costs.



Contra
Costa
County

To: Board of Supervisors
From: Anna Roth, Health Services Director
Date: March 8, 2022

Subject: Contract #77-150-2 with Seva Homecare, LLC (dba Alliance Home Health Care)

RECOMMENDATION(S):

APPROVE and AUTHORIZE the Health Services Director, or designee, to execute on behalf of the County Contract #77-150-2 with Seva Homecare, LLC (dba Alliance Home Health Care), a limited liability company, in an amount not to exceed \$225,000, to home health care services to Contra Costa Health Plan (CCHP) members and County recipients, for the period March 1, 2022 through February 28, 2023.

FISCAL IMPACT:

Approval of this contract will result in annual expenditures of up to \$225,000 and will be funded 100% by CCHP Enterprise Fund II revenues. (Rate increase)

BACKGROUND:

CCHP has an obligation to provide certain specialized home health care services for its members under the terms of their Individual and Group Health Plan membership contracts with the County. This contractor has been in the CCHP Provider Network providing services since March 1, 2018.

APPROVE

OTHER

RECOMMENDATION OF CNTY ADMINISTRATOR

RECOMMENDATION OF BOARD COMMITTEE

Action of Board On: **03/08/2022** APPROVED AS RECOMMENDED OTHER

Clerks Notes:

VOTE OF SUPERVISORS

AYE: John Gioia, District I Supervisor
Candace Andersen, District II Supervisor
Diane Burgis, District III Supervisor
Karen Mitchoff, District IV Supervisor
Federal D. Glover, District V Supervisor

I hereby certify that this is a true and correct copy of an action taken and entered on the minutes of the Board of Supervisors on the date shown.

ATTESTED: March 8, 2022

Monica Nino, County Administrator and Clerk of the Board of Supervisors

By: Laura Cassell, Deputy

Contact: Sharron Mackey, 925-313-6104

cc: Noel Garcia, Marcy Wilhelm

BACKGROUND: (CONT'D)

In March 2019, the County Administrator approved and the Purchasing Services Manager executed Contract #77-150-1 with Seva Homecare, LLC, (dba Alliance Home Health Care), in an amount not to exceed \$80,000, for the provision of home health care services for CCHP members for the period March 1, 2020 through February 28, 2022.

Approval of Contract #77-150-2 will allow the contractor to continue providing home health care services through February 28, 2023.

CONSEQUENCE OF NEGATIVE ACTION:

If this contract is not approved, certain specialized home health care services for CCHP members under the terms of their Individual and Group Health Plan membership contracts with the County will not be provided.



Contra
Costa
County

To: Board of Supervisors
From: Anna Roth, Health Services Director
Date: March 8, 2022

Subject: Amendment #26-745-18 with Medical Solutions, LLC (dba Nebraska Medical Solutions)

RECOMMENDATION(S):

APPROVE and AUTHORIZE the Health Services Director, or designee, to execute on behalf of the County Contract Amendment Agreement #26-745-18 with Medical Solutions, LLC (dba Nebraska Medical Solutions), a limited liability company, effective March 1, 2022, to increase the crisis rates for temporary nurse staffing services at Contra Costa Regional Medical Center (CCRMC), Contra Costa Health Centers and County's Detention Facilities with no increase in the payment limit of \$4,800,000, and no change in the original term of July 1, 2021 through June 30, 2022.

FISCAL IMPACT:

This amendment will not impact the contractual service expenditures in an amount not to exceed \$4,800,000 for fiscal year 2021-2022 and is funded 100% by Hospital Enterprise Fund I. (Rate increase)

BACKGROUND:

This contract meets the social needs of the County's population by providing temporary nursing services for CCRMC, Contra Costa Health Centers, and the County's Detention facilities. The contractor is able to provide coverage during peak workloads, temporary absences and emergency situations at CCRMC, Contra Costa Health Centers and the County's Detention Facilities and has been contracted with the County since July 1, 2013.

APPROVE

OTHER

RECOMMENDATION OF CNTY ADMINISTRATOR

RECOMMENDATION OF BOARD COMMITTEE

Action of Board On: **03/08/2022** APPROVED AS RECOMMENDED OTHER

Clerks Notes:

VOTE OF SUPERVISORS

AYE: John Gioia, District I Supervisor
Candace Andersen, District II Supervisor
Diane Burgis, District III Supervisor
Karen Mitchoff, District IV Supervisor
Federal D. Glover, District V Supervisor

I hereby certify that this is a true and correct copy of an action taken and entered on the minutes of the Board of Supervisors on the date shown.

ATTESTED: March 8, 2022

Monica Nino, County Administrator and Clerk of the Board of Supervisors

By: Laura Cassell, Deputy

Contact: Jaspreet Benepal, 925-370-5101

cc: L Walker, M Wilhelm

BACKGROUND: (CONT'D)

On June 8, 2021, the Board of Supervisors approved Contract #26-745-17 with Medical Solutions, LLC (dba Nebraska Medical Solutions) for the provision of temporary nursing and medical staff services for CCRMC, Health Centers and the County's Detention Facilities, for the period from July 1, 2021 through June 30, 2022.

Approval of Contract Amendment Agreement #26-745-18 will allow the contractor to continue to provide temporary medical staffing services through June 30, 2022. This amendment includes services provided by represented classifications and the County has met its obligations with the respective labor partner(s).

Due to Contra Costa County still being in the midst of the COVID-19 pandemic, CCRMC, Health Centers and Detention Facilities continue to experience a shortage in nursing staff due to multiple staff taking time off for COVID-19 isolations and illnesses. The County is challenged by the lack of agency nurses being available and willing to work on current billed rates, therefore the division is requesting to amend this contract to increase the crisis rates to retain agency nursing staff at CCRMC, Health Centers and Detention Facilities.

CONSEQUENCE OF NEGATIVE ACTION:

If this amendment is not approved, crisis rates will not be increased and hard to fill positions will continue to go unstaffed.



Contra
Costa
County

To: Board of Supervisors
From: Anna Roth, Health Services Director
Date: March 8, 2022

Subject: Purchase Order for Microsoft 365 Licensing California Department of Technology

RECOMMENDATION(S):

APPROVE and AUTHORIZE (1) the Purchasing Agent, on behalf of the Health Services Department, to execute a purchase order with California Department of Technology in an amount not to exceed \$12,235,000 for the procurement of G5 Microsoft 365 software licenses, and (2) the Health Services Director, or designee, to execute an Agreement with California Department of Technology for Microsoft software licenses for the period March 1, 2022 to March 31, 2026.

FISCAL IMPACT:

This purchase order will result in an annual increase of \$800,000 and for the first 3 years will be 100% funded by the Epidemiology and Laboratory Capacity (ELC) Grant funding, and by Hospital Enterprise Fund I in subsequent years.

BACKGROUND:

Contra Costa Health Services (CCHS) needs have changed and now require the use of Microsoft G5 license. Currently CCHS utilizes the G3 license which lacks specific security, active directory and business intelligence tools that are now required. In 2021, the California Department of Technology entered into an agreement with Microsoft authorized reseller Crayon Software Experts LLC (Crayon) that allows all public agencies to purchase Microsoft G5 licenses at the lowest available cost. CCHS will procure Microsoft 365 (M365) licensing through a California Department of Technology (CDT) negotiated, competitively bid contract with Crayon.

APPROVE

OTHER

RECOMMENDATION OF CNTY ADMINISTRATOR

RECOMMENDATION OF BOARD COMMITTEE

Action of Board On: **03/08/2022** APPROVED AS RECOMMENDED OTHER

Clerks Notes:

VOTE OF SUPERVISORS

AYE: John Gioia, District I Supervisor
Candace Andersen, District II Supervisor
Diane Burgis, District III Supervisor
Karen Mitchoff, District IV Supervisor
Federal D. Glover, District V Supervisor

I hereby certify that this is a true and correct copy of an action taken and entered on the minutes of the Board of Supervisors on the date shown.

ATTESTED: March 8, 2022

Monica Nino, County Administrator and Clerk of the Board of Supervisors

By: Laura Cassell, Deputy

Contact: Jaspreet Benepal 925-370-5100

cc:

BACKGROUND: (CONT'D)

Crayon is one of a handful of Microsoft Licensing Solutions Providers (LSPs) that are authorized to transact software/subscriptions via a Microsoft Enterprise Agreement licensing program. Crayon is the LSP that was selected by the California Department of Technology, after a competitively bid Request for Offer Process, to manage the CDT M365 G5 Agreement. The CDT contract with Crayon began on April 1, 2021 and runs through March 31, 2026 and will allow the County to reserve the required licenses by using an online application process through CDT.

As a party to CDT's Service Catalog General Terms and Conditions, which offers volume licensing discounts, with projected annual savings up to \$900,000.00 for CCHS compared to purchasing G5 licenses under our current Microsoft Enterprise Agreement. CCHS will utilize the contract starting on April 1, 2022 and participate for the remaining 4 years of the contract which ends on March 31, 2026.

CDT has negotiated M365 licensing through a competitive bid process which starts at a 25% discount off of current pricing in year-one with discounts that decrease in % over the five years. CDT will charge administrative fees of approximately 3.5% to broker/manage the statewide Enterprise Licensing Agreement (ELA).

The CDT contract with Crayon means that the County will be a Microsoft enrolled affiliate under the Enterprise Agreement between Microsoft and Riverside County. Microsoft contracts with a local agency in the state (previously San Bernardino, and now Riverside), and then permits other local agencies in the state to enroll under that agreement as affiliates. The CDT agreement obligates the County to defend and indemnify the CDT for third party claims caused by the County's violation of software licenses, copyrights, trademarks, trade names or any proprietary data, information or materials designated as confidential and supplied under the agreement. Under the Microsoft agreement the County is obligated to defend Microsoft for third party claims caused by the County's misappropriation of trade secrets or other rights of third parties or use of the Microsoft product in violation of law.

Approval of this purchase order will enable CCHS to continue to meet the demands of a fully integrated health system and improve the quality of services provided to our residents and businesses and reduce our cyber risks.

CONSEQUENCE OF NEGATIVE ACTION:

If this purchase order is not approved, CCHS will lose ELC Grant funding which will have a negative impact on the IT Division to meet the demands of the department.



Contra
Costa
County

To: Board of Supervisors
From: Anna Roth, Health Services Director
Date: March 8, 2022

Subject: Amendment #26-458-31 with AYA Healthcare, Inc.

RECOMMENDATION(S):

APPROVE and AUTHORIZE the Health Services Director, or designee, to execute on behalf of the County Contract Amendment Agreement #26-458-31 with AYA Healthcare, Inc., a corporation, effective March 1, 2022, to amend Contract #26-458-30, to increase the crisis rates for temporary nursing services for Contra Costa Regional Medical Center (CCRMC) and Contra Costa Health Centers with no change in the payment limit of \$3,000,000 or term July 1, 2021 through June 30, 2022.

FISCAL IMPACT:

Approval of this contract will not impact the annual expenditures of up to \$3,000,000 and will be funded as budgeted by the Department in FY 2021-2022 by 100% Hospital Enterprise Fund I allocations. (Rate increase)

BACKGROUND:

CCRMC and Contra Costa Health Centers have an obligation to provide medical staffing services to patients. Therefore, the County contracts with temporary help firms to ensure patient care is provided during peak loads, temporary absences, vacations and emergency situations where additional nurse staffing is required. The County has been using the contractor's temporary staffing services since July 1, 2008.

APPROVE

OTHER

RECOMMENDATION OF CNTY ADMINISTRATOR

RECOMMENDATION OF BOARD COMMITTEE

Action of Board On: **03/08/2022** APPROVED AS RECOMMENDED OTHER

Clerks Notes:

VOTE OF SUPERVISORS

AYE: John Gioia, District I Supervisor
Candace Andersen, District II Supervisor
Diane Burgis, District III Supervisor
Karen Mitchoff, District IV Supervisor
Federal D. Glover, District V Supervisor

I hereby certify that this is a true and correct copy of an action taken and entered on the minutes of the Board of Supervisors on the date shown.

ATTESTED: March 8, 2022

Monica Nino, County Administrator and Clerk of the Board of Supervisors

By: Laura Cassell, Deputy

Contact: Jaspreet Benepal, 925-370-5100

cc: Leslie A Walker, M Wilhelm

BACKGROUND: (CONT'D)

On June 27, 2021, the Board of Supervisors approved Contract #26-458-30 with AYA Healthcare, Inc., in an amount not to exceed \$1,500,000 for the provision of temporary nursing services for CCRMC and Contra Costa Health Centers to cover during temporary absences and shortages of nurses in critical areas for the period July 1, 2021 through June 30, 2022.

Approval of Amendment Agreement #26-458-31 will increase the crisis rates for temporary nurse staffing and allow the contractor to continue to provide temporary staffing services through June 30, 2022.

This amendment includes services provided by represented classifications and the County has met its obligations with the respective labor partner(s).

Due to Contra Costa County still being in the midst of the COVID-19 pandemic, CCRMC and Health Centers continue to experience a shortage in nursing staff due to multiple staff taking time off for COVID-19 isolations and illnesses. The County is challenged by the lack of agency nurses being available and willing to work on current billed rates, therefore the Division is requesting to amend this contract to increase the crisis rates to retain agency nursing staff at CCRMC and Health Centers.

CONSEQUENCE OF NEGATIVE ACTION:

If this amendment is not approved, crisis rates will not be increased and hard to fill positions will continue to go unstaffed.



Contra
Costa
County

To: Board of Supervisors
From: Anna Roth, Health Services Director
Date: March 8, 2022

Subject: Amendment #26-391-34 with Maxim Healthcare Services, Inc.

RECOMMENDATION(S):

APPROVE and AUTHORIZE the Health Services Director, or designee, to execute Contract Amendment Agreement #26-391-34 with Maxim Healthcare Services, Inc., a corporation, effective March 1, 2022, to amend Contract #26-391-33, to increase the crisis rates for temporary nurse staffing services at Contra Costa Regional Medical Center (CCRMC) and Contra Costa Health Centers with no change in the payment limit of \$2,000,000 or term July 1, 2021 through June 30, 2022.

FISCAL IMPACT:

Approval of this contract will not impact the annual expenditures of up to \$2,000,000 and will be funded as budgeted by the Department in FY 2021-2022 by 100% Hospital Enterprise Fund I allocations. (Rate increase)

BACKGROUND:

CCRMC and Contra Costa Health Centers have an obligation to provide medical staffing services to patients. Therefore, the County contracts with temporary help firms to ensure patient care is provided during peak loads, temporary absences, vacations and emergency situations where additional staffing is required. The County has been using the contractor's temporary staffing services since July 1, 2000.

-
- APPROVE OTHER
 - RECOMMENDATION OF CNTY ADMINISTRATOR RECOMMENDATION OF BOARD COMMITTEE
-

Action of Board On: **03/08/2022** APPROVED AS RECOMMENDED OTHER

Clerks Notes:

VOTE OF SUPERVISORS

- AYE:
- John Gioia, District I Supervisor
 - Candace Andersen, District II Supervisor
 - Diane Burgis, District III Supervisor
 - Karen Mitchoff, District IV Supervisor
 - Federal D. Glover, District V Supervisor

I hereby certify that this is a true and correct copy of an action taken and entered on the minutes of the Board of Supervisors on the date shown.

ATTESTED: March 8, 2022
Monica Nino, County Administrator and Clerk of the Board of Supervisors

By: Laura Cassell, Deputy

Contact: Jaspreet Benepal, 925-370-5501

cc: L Walker, M Wilhelm

BACKGROUND: (CONT'D)

On June 22, 2021, the Board of Supervisors approved Contract #26-391-33 with Maxim Healthcare Services, Inc., in an amount not to exceed \$2,000,000 to provide temporary medical staffing services for coverage of employee sick leaves, vacations and workers compensation leaves, at CCRMC and Contra Costa Health Centers for the period July 1, 2021 through June 30, 2022.

Approval of Amendment Agreement #26-391-34 will increase the crisis rates and allow the contractor to continue providing temporary medical staffing services through June 30, 2022. This amendment includes services provided by represented classifications and the County has met its obligations with the respective labor partner(s).

Due to Contra Costa County still being in the midst of the COVID-19 pandemic, CCRMC and Health Centers continue to experience a shortage in nursing staff due to multiple staff taking time off for COVID-19 isolations and illnesses. The County is challenged by the lack of agency nurses being available and willing to work on current billed rates, therefore the Division is requesting to amend this contract to increase the crisis rates to retain agency nursing staff at CCRMC and Health Centers.

CONSEQUENCE OF NEGATIVE ACTION:

If this amendment is not approved, crisis rates will not be increased and hard to fill positions will continue to go unstaffed.



Contra
Costa
County

To: Board of Supervisors
From: Brian M. Balbas, Public Works Director/Chief Engineer
Date: March 8, 2022

Subject: APPROVE and Authorize a Purchase Order with Air Products Group.

RECOMMENDATION(S):

APPROVE and AUTHORIZE the Purchasing Agent, or designee, to execute on behalf of the Public Works Director, a purchase order with Air Products Group in an amount not to exceed \$550,000 for heating, ventilation and air conditioning filtration components for the period of March 8, 2022 through February 28, 2024, Countywide.

FISCAL IMPACT:

Facilities Maintenance Budget. (100% General Fund)

BACKGROUND:

Facilities Services maintains all County buildings, including hospitals, clinics, detention centers, and congregate care facilities. Heating, ventilation and air conditioning filtration is part of this maintenance and these products ensure the air filtration systems are performing at their optimum level. Each building maintained by Facilities Services uses several types and sizes of air filters, each designed for specific purposes (e.g., pollen removal, biohazard, prevention, etc.).

This request is for a two-year purchase order. The purchase order will be used as needed, with no minimum amount that must be used.

APPROVE

OTHER

RECOMMENDATION OF CNTY ADMINISTRATOR

RECOMMENDATION OF BOARD COMMITTEE

Action of Board On: **03/08/2022** APPROVED AS RECOMMENDED OTHER

Clerks Notes:

VOTE OF SUPERVISORS

AYE: John Gioia, District I Supervisor
Candace Andersen, District II Supervisor
Diane Burgis, District III Supervisor
Karen Mitchoff, District IV Supervisor
Federal D. Glover, District V Supervisor

I hereby certify that this is a true and correct copy of an action taken and entered on the minutes of the Board of Supervisors on the date shown.

ATTESTED: March 8, 2022

Monica Nino, County Administrator and Clerk of the Board of Supervisors

By: Laura Cassell, Deputy

Contact: Ted Lavelle, (925) 313-7077

cc:

CONSEQUENCE OF NEGATIVE ACTION:

If this amendment is not approved, then purchasing through Air Products Group for heating, ventilation and air-conditioning filtration will be discontinued.



Contra
Costa
County

To: Board of Supervisors
From: Ann Elliott, Human Resources Director
Date: March 8, 2022

Subject: Contract Extension of Fiduciary Consulting Services with Segal Advisors for the County's 457 Deferred Compensation plan

RECOMMENDATION(S):

APPROVE and AUTHORIZE the Human Resources Director, or designee, to execute a contract amendment with Segal Advisors, Inc. including modified indemnification language, to extend the term from April 1, 2022 through March 31, 2023, and increase the payment limit by \$60,000 to a new payment limit of \$270,000 .

FISCAL IMPACT:

The program is funded through plan participant fees. There is no fiscal impact beyond overhead administration support costs which is reimbursed annually through the plan.

BACKGROUND:

Segal Advisors provide fiduciary consulting services for the County. These services assist the County with performance evaluation, measurement allocation and investment strategy for the County's 457 Deferred Compensation plan. Pursuant to the parties' contract, Segal Advisors perform the following advisory and fiduciary consulting services, among others: 1) attendance at meetings; 2) investment management search and selection; 3) investment performance monitoring; 4) administrative services monitoring; and 5) general consulting.

APPROVE

OTHER

RECOMMENDATION OF CNTY ADMINISTRATOR

RECOMMENDATION OF BOARD COMMITTEE

Action of Board On: **03/08/2022** APPROVED AS RECOMMENDED OTHER

Clerks Notes:

VOTE OF SUPERVISORS

AYE: John Gioia, District I Supervisor
Candace Andersen, District II Supervisor
Diane Burgis, District III Supervisor
Karen Mitchoff, District IV Supervisor
Federal D. Glover, District V Supervisor

I hereby certify that this is a true and correct copy of an action taken and entered on the minutes of the Board of Supervisors on the date shown.

ATTESTED: March 8, 2022

Monica Nino, County Administrator and Clerk of the Board of Supervisors

By: Laura Cassell, Deputy

Contact: Salma Sadiq, (925) 655-2176

cc:

CONSEQUENCE OF NEGATIVE ACTION:

If this extension is not approved, the County will be not be able to access the expertise and support of Segal Advisors to assist the County in measurement allocation and investment strategy for the County's 457 Deferred Compensation plan.



Contra
Costa
County

To: Board of Supervisors
From: Anna Roth, Health Services Director
Date: March 8, 2022

Subject: Contract #74-514-8 with Robin Wendy Asher, M.D.

RECOMMENDATION(S):

APPROVE and AUTHORIZE the Health Services Director, or designee, to execute on behalf of the County Contract #74-514-8 with Robin Wendy Asher, M.D., an individual, in an amount not to exceed \$239,616, to provide outpatient psychiatric care services to children and adolescents in Central Contra Costa County, for the period from April 1, 2022 through March 31, 2023.

FISCAL IMPACT:

Approval of this contract will result in annual budgeted expenditures of up to \$239,616 and will be funded by 50% Federal Medi-Cal (\$119,808) and 50% Mental Health Realignment Fund (\$119,808) revenues.

BACKGROUND:

This contract meets the social needs of the County’s population by providing mental health services to children and adolescents with emotional and behavioral problems to improve school performance and reduce unsafe behavioral practices. The County on behalf of its Behavioral Health Division has been contracting with Robin Wendy Asher, M.D. since April 2016 for her expertise in providing outpatient psychiatric care to children and adolescents.

APPROVE

OTHER

RECOMMENDATION OF CNTY ADMINISTRATOR

RECOMMENDATION OF BOARD COMMITTEE

Action of Board On: **03/08/2022** APPROVED AS RECOMMENDED OTHER

Clerks Notes:

VOTE OF SUPERVISORS

AYE: John Gioia, District I Supervisor
Candace Andersen, District II Supervisor
Diane Burgis, District III Supervisor
Karen Mitchoff, District IV Supervisor
Federal D. Glover, District V Supervisor

I hereby certify that this is a true and correct copy of an action taken and entered on the minutes of the Board of Supervisors on the date shown.

ATTESTED: March 8, 2022

Monica Nino, County Administrator and Clerk of the Board of Supervisors

Contact: Suzanne Tavano, Ph.D.,
925-957-5169

By: Laura Cassell, Deputy

cc: Alaina Floyd, marcy.wilham

BACKGROUND: (CONT'D)

On April 20, 2021, the Board of Supervisors approved Contract #74-514-7 with Robin Wendy Asher, M.D., in an amount of \$239,616 to provide outpatient psychiatric services to children and adolescents in Central Contra Costa County, including diagnosing, counseling, evaluation, and medical and therapeutic treatment and consulting and training in medical and therapeutic matters for the period from April 1, 2021 through March 31, 2022.

Approval of Contract #74-514-8 will allow the contractor to continue providing psychiatric services through March 31, 2023.

CONSEQUENCE OF NEGATIVE ACTION:

If this contract is not approved, the County's clients will not have access to this contractor's psychiatric care services.

CHILDREN'S IMPACT STATEMENT:

This contract supports the following Board of Supervisors' community outcomes: "Children Ready for and Succeeding in School"; "Families that are Safe, Stable, and Nurturing"; and "Communities that are Safe and Provide a High Quality of Life for Children and Families". Expected program outcomes include an increase in positive social and emotional development as measured by the Child and Adolescent Functional Assessment Scale (CAFAS).



Contra
Costa
County

To: Board of Supervisors
From: Anna Roth, Health Services Director
Date: March 8, 2022

Subject: Amendment #26-346-27 with the U.S. Department of Veterans Affairs

RECOMMENDATION(S):

APPROVE and AUTHORIZE the Health Services Director, or designee, to execute on behalf of the County Amendment/Extension Agreement #26-346-27, with the U.S. Department of Veterans Affairs, Northern California Health Care System (VANHCSS), including mutual indemnification, to amend Agreement #26-346-21 (as amended by Amendment Agreements #26-346-22 through #26-346-26) to increase the payment limit by \$680,000, from \$2,294,377 to a new payment limit not to exceed \$2,974,377 and to extend the termination date from March 31, 2022 to March 31, 2023 for nuclear medicine services at Contra Costa Regional Medical Center (CCRMC).

FISCAL IMPACT:

Approval of this contract will result in budgeted expenditures of up to \$2,974,377 over a 5-year period and will be funded 100% by Hospital Enterprise Fund I revenues. The services provided for the County's patients under this contract are billable to patients and third-party payors.

BACKGROUND:

For many years, the County and VANHCSS have maintained a mutual sharing agreement, which has made available to the County specialized medical services not otherwise available due to lack of resources, equipment, and personnel.

APPROVE

OTHER

RECOMMENDATION OF CNTY ADMINISTRATOR

RECOMMENDATION OF BOARD COMMITTEE

Action of Board On: **03/08/2022** APPROVED AS RECOMMENDED OTHER

Clerks Notes:

VOTE OF SUPERVISORS

AYE: John Gioia, District I Supervisor
Candace Andersen, District II Supervisor
Diane Burgis, District III Supervisor
Karen Mitchoff, District IV Supervisor
Federal D. Glover, District V Supervisor

I hereby certify that this is a true and correct copy of an action taken and entered on the minutes of the Board of Supervisors on the date shown.

ATTESTED: March 8, 2022

Monica Nino, County Administrator and Clerk of the Board of Supervisors

By: Laura Cassell, Deputy

Contact: Jaspreet Benepal, 925-370-5501

cc: L Walker, M Wilhelm

BACKGROUND: (CONT'D)

These services included specialized laboratory testing, radiology services, nuclear medicine studies, computerized tomography (CT) scans, magnetic resonance imaging (MRI), dermatology, gastroenterology, urology, audiology and speech, and ophthalmology services. The County provides Emergency Room treatment and inpatient care, including certain ancillary services, for VANCHCS referred patients.

On March 27, 2018, the Board of Supervisors approved Agreement #26-346-21 with VANCHCS to provide a full range of Nuclear Medicine Services to County's patients at the VANCHCS Outpatient Clinic in Martinez and CCRMC's Nuclear Medicine Department, in an amount not to exceed \$474,000 for the period April 1, 2018 through March 31, 2019.

On July 24, 2018, the Board of Supervisors approved Amendment Agreement #26-346-22 with VANCHCS to modify the Rate Schedule, with no change in the original contract payment limit of \$474,000, and no change in the original term of April 1, 2018 through March 31, 2019.

On April 9, 2019, the Board of Supervisors approved Amendment Agreement #26-346-23 with VANCHCS to increase the payment limit by \$515,737 to a new payment limit of \$989,737, and to extend the term through March 31, 2020.

On January 7, 2020, the Board of Supervisors approved Amendment Agreement #26-346-24 with VANCHCS to increase the payment limit by \$594,640 to a new payment limit of \$1,584,377, with no change in the term of April 1, 2018 through March 31, 2020.

On March 31, 2020, the Board of Supervisors approved Amendment Agreement #26-346-25 with VANCHCS to increase the payment limit by \$710,000 to a new payment limit of \$2,294,377, and to extend term through March 31, 2021.

On April 27, 2021, the Board of Supervisors approved Amendment Agreement #26-346-26 with VANCHCS to extend the termination date from March 31, 2021 March 31, 2022 with no change in the payment limit of \$2,294,377.

Approval of Amendment Agreement #26-346-27 will allow the contractor to provide additional nuclear medicine services through March 31, 2023. This contract includes mutual indemnification to hold harmless both parties for any claims arising out of the performance of this agreement.

CONSEQUENCE OF NEGATIVE ACTION:

If this amendment is not approved, VANCHCS will not be able to continue to provide nuclear medicine services to CCRMC patients.



Contra
Costa
County

To: Board of Supervisors
From: Anna Roth, Health Services Director
Date: March 8, 2022

Subject: Contract #77-015-4 with Golden State Dermatology Associates, Inc.

RECOMMENDATION(S):

APPROVE and AUTHORIZE the Health Services Director, or designee, to execute on behalf of the County Contract #77-015-4 with Golden State Dermatology Associates, Inc., a corporation, in an amount not to exceed \$1,200,000, to provide dermatology and otolaryngology services to Contra Costa Health Plan (CCHP) members and County recipients, for the period from April 1, 2022 through March 31, 2025.

FISCAL IMPACT:

This contract will result in contractual service expenditures of up to \$1,200,000 over a three-year period and will be funded 100% by CCHP Enterprise Fund II revenues. (No rate increase)

BACKGROUND:

CCHP has an obligation to provide certain specialized dermatology and otolaryngology services for its members under the terms of their Individual and Group Health Plan membership contracts with the County. This contractor has been in the CCHP Provider Network providing these services since April 1, 2016.

-
- APPROVE OTHER
 - RECOMMENDATION OF CNTY ADMINISTRATOR RECOMMENDATION OF BOARD COMMITTEE
-

Action of Board On: **03/08/2022** APPROVED AS RECOMMENDED OTHER

Clerks Notes:

VOTE OF SUPERVISORS

- AYE: John Gioia, District I Supervisor
 Candace Andersen, District II Supervisor
 Diane Burgis, District III Supervisor
 Karen Mitchoff, District IV Supervisor
 Federal D. Glover, District V Supervisor

I hereby certify that this is a true and correct copy of an action taken and entered on the minutes of the Board of Supervisors on the date shown.

ATTESTED: March 8, 2022
 Monica Nino, County Administrator and Clerk of the Board of Supervisors

By: Laura Cassell, Deputy

Contact: Sharron Mackey, 925-313-6104

cc: Noel Garcia, Marcy Wilhelm

BACKGROUND: (CONT'D)

In May 2019, the County Administrator approved and the Purchasing Services Manager executed Contract #77-015-3 with Golden State Dermatology Associates, Inc., in an amount not to exceed \$100,000 for the provision of dermatology services for CCHP members for the period from April 1, 2020 through March 31, 2022.

Approval of Contract #77-015-4 will allow the contractor to continue providing dermatology services with the addition of otolaryngology services through March 31, 2025.

CONSEQUENCE OF NEGATIVE ACTION:

If this contract is not approved, certain specialized dermatology and otolaryngology health care services for CCHP members under the terms of their Individual and Group Health Plan membership contracts with the County will not be provided.



Contra
Costa
County

To: Board of Supervisors
From: Anna Roth, Health Services Director
Date: March 8, 2022

Subject: Contract #22-780-21 with John Muir Health, Inc. (dba Community Health Improvement)

RECOMMENDATION(S):

APPROVE and AUTHORIZE the Health Services Director, or designee, to execute on behalf of the County Contract #22-780-21, containing mutual indemnification, with John Muir Health, Inc. (dba Community Health Improvement), a non-profit corporation, in an amount not to exceed \$3,000 for the County's use of a mobile van to provide healthcare services to low-income families and individuals, in Central, East and West Contra Costa County for the period from January 1, 2022 through December 31, 2022.

FISCAL IMPACT:

Approval of this contract will result in budgeted annual expenditures of up to \$3,000 and is funded by 100% Federal Fund allocations.

BACKGROUND:

The Public Health Department has been contracting with John Muir Health, Inc. (dba Community Health Improvement), since August 15, 2000 to provide a mobile van to provide healthcare services to low-income families and individuals, in Central, East and West Contra Costa County.

APPROVE OTHER
 RECOMMENDATION OF CNTY ADMINISTRATOR RECOMMENDATION OF BOARD COMMITTEE

Action of Board On: **03/08/2022** APPROVED AS RECOMMENDED OTHER

Clerks Notes:

VOTE OF SUPERVISORS

AYE: John Gioia, District I Supervisor
Candace Andersen, District II Supervisor
Diane Burgis, District III Supervisor
Karen Mitchoff, District IV Supervisor
Federal D. Glover, District V Supervisor

I hereby certify that this is a true and correct copy of an action taken and entered on the minutes of the Board of Supervisors on the date shown.

ATTESTED: March 8, 2022

Monica Nino, County Administrator and Clerk of the Board of Supervisors

By: Laura Cassell, Deputy

Contact: Ori Tzvieli, M.D., 925-608-5267

cc: Alaina Floyd, marcy.wilham

BACKGROUND: (CONT'D)

On January 19, 2021, the Board of Supervisors approved Contract #22-780-20 with John Muir Health, Inc. (dba Community Health Improvement), in an amount not to exceed \$3,000 for the County's use of a mobile van to provide healthcare services to low-income families and individuals, in Central, East and West Contra Costa County, for the period from January 1, 2021 through December 31, 2021, which included a six-month automatic extension through December 31, 2021.

Approval of Contract #22-780-21 will allow the contractor to continue providing services through December 31, 2022. This contract includes mutual indemnification to hold harmless both parties for any claims arising out of the performance of this contract.

CONSEQUENCE OF NEGATIVE ACTION:

If this contract is not approved, many low-income families and disadvantaged individuals in Contra Costa County will not receive much needed health services.



Contra
Costa
County

To: Board of Supervisors
From: David O. Livingston, Sheriff-Coroner
Date: March 8, 2022

Subject: Purchase Order - Surtec, Inc.

RECOMMENDATION(S):

APPROVE and AUTHORIZE the Purchasing Agent to execute, on behalf of the Sheriff-Coroner, a purchase order with Surtec Inc., in the amount of \$450,000 to supply the County's detention facilities with custodial supplies/specialty products and janitorial equipment repair for the period March 1, 2022 through February 28, 2023.

FISCAL IMPACT:

\$450,000. 100% General Fund; Budgeted.

BACKGROUND:

Surtec Inc., supplies solutions for the 40 specialized disinfectant dispensers installed in all the detention facilities. These are dispensers with locks, specifically for the jail environment to keep the inmates from having physical contact with the chemicals. This vendor carries the majority of the cleaning solutions used in facilities that keeps the County detention facilities in compliance with the strict requirements of the State Board of Corrections' annual facility inspections and other State regulations.

CONSEQUENCE OF NEGATIVE ACTION:

If unapproved, the Sheriff's Office may be unable to acquire needed janitorial products to service the county adult detention facilities.

CHILDREN'S IMPACT STATEMENT:

No impact.

APPROVE

OTHER

RECOMMENDATION OF CNTY ADMINISTRATOR

RECOMMENDATION OF BOARD COMMITTEE

Action of Board On: **03/08/2022** APPROVED AS RECOMMENDED OTHER

Clerks Notes:

VOTE OF SUPERVISORS

AYE: John Gioia, District I Supervisor
John Gioia, District I Supervisor
Candace Andersen, District II Supervisor
Candace Andersen, District II Supervisor
Diane Burgis, District III Supervisor
Diane Burgis, District III Supervisor
Karen Mitchoff, District IV Supervisor
Karen Mitchoff, District IV Supervisor
Federal D. Glover, District V Supervisor
Federal D. Glover, District V Supervisor

I hereby certify that this is a true and correct copy of an action taken and entered on the minutes of the Board of Supervisors on the date shown.

ATTESTED: March 8, 2022

, County Administrator and Clerk of the Board of Supervisors

By: Laura Cassell, Deputy

Contact: Heike Anderson, 925 655-0023

cc: Heike Anderson, Alycia Rubio, Paul Reyes



Contra
Costa
County

To: Board of Supervisors
From: LEGISLATION COMMITTEE
Date: March 8, 2022

Subject: Update to Administrative Bulletin 110.4 Legislation

RECOMMENDATION(S):

1. APPROVE Administrative Bulletin 110.5 Legislation, Regulation, and Intergovernmental Relations, which updates Administrative Bulletin 110.4 Legislation dated 01/04/1982.
2. DIRECT the County Administrator to promulgate and enforce adherence to the updated Administrative Bulletin.

FISCAL IMPACT:

There are no costs associated with this action.

BACKGROUND:

The County Administrator's Office is responsible for the development and administration of the County's Administrative Bulletins, which set forth County policy on general business matters including budget and fiscal matters, payroll and timekeeping, personnel, property and equipment, and purchasing. All Administrative Bulletins are approved by the County Administrator.

Staff of the County Administrator's Office have drafted proposed revisions

APPROVE

OTHER

RECOMMENDATION OF CNTY ADMINISTRATOR

RECOMMENDATION OF BOARD COMMITTEE

Action of Board On: **03/08/2022** APPROVED AS RECOMMENDED OTHER

Clerks Notes:

VOTE OF SUPERVISORS

AYE: John Gioia, District I Supervisor
Candace Andersen, District II Supervisor
Diane Burgis, District III Supervisor
Karen Mitchoff, District IV Supervisor
Federal D. Glover, District V Supervisor

I hereby certify that this is a true and correct copy of an action taken and entered on the minutes of the Board of Supervisors on the date shown.

ATTESTED: March 8, 2022

Monica Nino, County Administrator and Clerk of the Board of Supervisors

By: Stacey M. Boyd, Deputy

Contact: L. DeLaney, 925-655-2057

cc:

BACKGROUND: (CONT'D)

to the Administrative Bulletin 110.4 Legislation, which was established in 1982. (Attachment A)

As a unit of the state government, Contra Costa County is greatly affected by both state and federal legislation and regulation. Regular sessions of the California Legislature and Congress are held biennially. Many of the bills introduced and enacted into law, including budget bills and trailer bills, directly impact the operations of county government, as do ballot measures that are passed by voters. Recognizing the need for consistency in conveying the County's positions on federal and state legislative and regulatory matters and to provide an effective program of legislative representation, Contra Costa County coordinates interactions among the Board of Supervisors, the County Administrator's Office, County departments/agencies, County advisory bodies, and the County's contract legislative advocates in Sacramento and Washington, D.C.

The proposed revisions to Administrative Bulletin 110.4 provide more explicit information and direction on the process developed in Contra Costa County for engagement on legislation, regulation, and intergovernmental relations at the state and federal levels. (Attachment B)

At its February 14, 2022 meeting, the Legislation Committee of the Board of Supervisors (Chair Burgis/Vice Chair Mitchoff) reviewed the proposed revisions and directed staff to send to the Board of Supervisors for approval.

ATTACHMENTS

Attachment A

Attachment B

CONTRA COSTA COUNTY
Office of the County Administrator

ADMINISTRATIVE BULLETIN

Number: 110.4
Date: 1-4-82
Section: General

SUBJECT: Legislation

As a unit of the state government, Contra Costa County is greatly affected by state legislation. Regular sessions of the Legislature are held biennially. Many of the bills introduced during each session directly impact upon the operations of county government. The regulations contained in this bulletin have been developed to guide county officers and employees in matters concerning legislation and relationships between the County and legislators.

I. Legislative Coordination

The County Administrator will coordinate the activities of the County related to legislation, including:

- A. Development of the County Legislative Program for consideration by the Board of Supervisors.
- B. Serving as the "clearing house" for all contacts in the name of the County by county officers and employees with state legislators and state administrative officials.
Official contacts on behalf of the County include:
 1. Communication with legislators and state administrative officials on legislative matters.
Correspondence emanating from the County will be transmitted via the County Administrator.
 2. Participation with legislators and state administrative officials in drafting of bills, policies, and regulations which affect Contra Costa County.
 3. Appearances to speak for Contra Costa County before legislative committees, including regular and interim committee hearings, special study commissions, and administrative hearings.

II. County Legislative Program

The "County Legislative Program" is developed each calendar year and consists of those bills initiated by the County upon approval by the Board of Supervisors.

- A. During periods between regular legislative sessions, departments should be alert to the need for new legislation and modification of existing legislation. Proposed bills or legislative changes should be brought to the attention of the County Administrator so that they may be considered for inclusion in the County Legislative Program.
- B. Proposed legislation may be screened by a committee consisting of two members of the Board of Supervisors, the County Administrator, the County Counsel, and the department heads concerned and, if approved by that committee, submitted to the Board of Supervisors for consideration.
- C. Proposed legislation endorsed by the Board of Supervisors will be included in the County Legislative Program. The Office of the County Counsel will be responsible for bill preparation in draft form. The Office of the County Administrator is responsible for arranging introduction of proposed measures through the County Legislative Delegation.
- D. The County Administrator will provide for and coordinate the attendance of county officers and employees in Sacramento in support of the County Legislative Program.

III. Other State Legislation

The Office of the County Administrator shall subscribe to the Legislative Bill Service, under which copies of all bills, resolutions, digests, summaries and indexes are received, and shall make these materials available to county officials as needed. Appropriate forms will be developed by the County Administrator to transmit these materials to the various agencies and departments. County officials should seek to keep informed on legislation pertaining to functions under their supervision and should call to the attention of the County Administrator any bills of importance to the County. The departmental position should be stated and, when appropriate, a recommendation for a formal county position should be offered.

- A. The Legislative Screening Committee referred to in Section II. 2. above may evaluate requests to endorse or oppose legislation and make recommendations to the Board of Supervisors on what formal position, if any, should be adopted by the County.
- B. Generally the county position on legislation will conform to, or at least will not conflict with, formal policy positions adopted by the County Supervisors Association of California (CSAC). The County Administrator will advise the Board of Supervisors in this regard and will

communicate formal County policy positions on legislation to appropriate State officials, including legislators, and to CSAC.

- C. The Board of Supervisors shall establish the official County position on bills and other matters (if one is established), and County officials and employees shall support that position when designated to represent the County. County representatives will be designated by the County Administrator in advance to appear and speak in support of the County position on legislation. A representative of the Office of the County Administrator located in Sacramento (Legislative Coordinator) will arrange such appearances and testimony so that duplicate or conflicting testimony will be avoided.

IV. Expense Reimbursement

Expense reimbursement, in accordance with the county expense reimbursement policy, is authorized for personnel traveling to Sacramento (or other locations) in support of legislation only in those instances in which officers and employees are on official business, such as representing the official position of the county or the official position of an association of county officials of which they are a member, such as the County Auditors or County Clerks Association.

V. Support of Legislation

From time to time, officially constituted groups, such as employee organizations, may wish to request endorsement of legislation by the Board of Supervisors. In such instances the procedure outlined under the hearing entitled "County Legislative Program" will apply and the Board of Supervisors, if it chooses to endorse the legislation, may direct the legislative representative, county officials, and employees to act in support of the bill. Such assistance may be rendered at county expense and department heads and employees will be continued in their regular pay status.

Nothing in this regulation shall preclude officers and employees from taking a position different from the formal county position before the Legislature when they are acting in other capacities, however, such as representing an association of county officers or an employee group, or expressing a personal opinion. In all such situations the officer or employee shall clearly indicate that he is not representing the County but rather some other agency or expressing a personal opinion.

In instances where legislation sponsored by employee or other groups does not have the endorsement of the Board of Supervisors, employees may not make representation in any way on behalf of the County. Time taken and travel costs incurred will be at their own expense. Time taken during working hours

may be charged to vacation leave or to leave without pay and shall be subject to approval of the department head in each instance.

VI. Application of Rules and Procedures

The rules and procedures as set forth in this bulletin shall apply to testimony presented to regular and interim committees of the Legislature, as well as to testimony presented to any special study commissions.

Originating Office: County Administrator

/s/ M. G. Wingett

County Administrator

CONTRA COSTA COUNTY
Office of the County Administrator

ADMINISTRATIVE BULLETIN

Number: 110.5
Date: 3-8-22
Section: General

SUBJECT: Legislation, Regulation, and Intergovernmental Relations

Contents:

- I. Purpose
- II. The County's State and Federal Legislative Platforms
- III. Process for Pursuing County-sponsored Legislation, State Budget Requests and Federal Appropriations Requests
- IV. Process for Obtaining an Official County Position on Pending State and Federal Legislation
- V. Positions and Comments on Federal and State Rulemaking and Federal and State Budget Legislation
- VI. Statewide Ballot Propositions and Local Ballot Measures
- VII. Legislative Advocacy
 - A. Advocacy Efforts on Behalf of the County
 - B. Advocacy That Is Not on Behalf of the County
- VIII. Legislative and Regulatory Activity Coordination
- IX. Expense Reimbursement
- X. Application of Rules and Procedures

I. Purpose:

As a unit of the state government, Contra Costa County is greatly affected by both state and federal legislation and regulation. Regular sessions of the California Legislature and Congress are held biennially. Many of the bills introduced and enacted into law, including budget bills and trailer bills, directly impact the operations of county government, as do ballot measures that are passed by voters. Recognizing the need for consistency in conveying the County's positions on federal and state legislative and regulatory matters and to provide an effective program of legislative representation, Contra Costa County coordinates interactions among the Board of Supervisors, the County Administrator's Office, County departments/agencies, County advisory bodies, and the County's contract legislative advocates in Sacramento and Washington, D.C.

This bulletin has been developed for the following purposes:

- to guide County officers and employees in matters concerning legislation and regulation,

- to facilitate participation in these matters by County departments, agencies and advisory bodies,
- to ensure that advocacy efforts are expeditious and consistent with Board-approved positions, and
- to allow the County Administrator's Office to act as a central coordinator of the legislative and regulatory activities of the County and a clearinghouse for intergovernmental relations.

II. The County's State and Federal Legislative Platforms

The County's annual program of legislative and regulatory activity is developed to secure legislation and/or regulation that benefits the County and its residents; oppose/amend legislation and regulation that might adversely impact the County's delivery of services; shape public policy in areas that impact County government and operations; and secure state and federal funding for County purposes through the budget, grant and/or appropriations process.

Upon approval by the Board of Supervisors, the County's annual program is centered on the sponsored bills and appropriation requests initiated by the County as well as the County's legislative priorities, which are included in the County's adopted *State and Federal Legislative Platforms* ("*Platforms*"). The *Platforms* serves as a tool for focusing on and achieving the County's legislative goals.

The following process shall be used to develop the *Platforms*:

- A. Each fall/winter, the County Administrator's Office will conduct outreach to departments, agencies, and the members of the Board of Supervisors to solicit input on and recommended changes to the *Platforms*. (*Note that departments and agencies are encouraged to outreach to advisory bodies for which they provide administrative support for this purpose.*)
- B. Proposed changes to the *Platforms* will be considered by the Board's Legislation Committee, and draft *Platforms* will be recommended by the Legislation Committee for adoption by the Board of Supervisors.
- C. In January of each odd-numbered year, the County Administrator's Office will present the County's *Platforms* to the Board of Supervisors for consideration and adoption. Unless later amended, the *Platforms* will be the County's official policy/legislative agenda for the two years after adoption.
- D. In January of each even-numbered year, the County Administrator's Office will provide the Board of Supervisors an update of the County's legislative priorities, sponsored bills, and appropriations requests. The update will reflect evolving

policy developments at the state and/or federal levels. The update may also seek the Board of Supervisors' approval of amendments to the *Platforms*.

- E. Departments, agencies, and advisory bodies should be alert to the need for new legislation and modification of existing legislation or law. Proposed bills or legislative changes should be brought to the attention of the County Administrator's Office so that they may be considered for inclusion in the *Platforms*.

III. Process for Pursuing County-sponsored Legislation, State Budget Requests, and Federal Appropriations Requests:

- A. Each fall/winter, the County Administrator's Office will solicit proposals for County-sponsored legislation, state budget requests, and federal appropriations requests from all departments, agencies and the Board of Supervisors.
- B. Proposals for County-sponsored legislation and appropriations requests will be screened by a committee of the Board of Supervisors and, if approved by the committee, submitted to the Board of Supervisors for consideration.
- C. Proposals for County-sponsored legislation and appropriation requests that have been endorsed by the Board of Supervisors will be included in the *Platforms*.
- D. Legislation proposed by the County (County-sponsored bills) will be reviewed and, in some instances, drafted by the Office of the County Counsel after concept authorization by the Board of Supervisors.
- E. The County Administrator's Office, through the County's legislative advocates, will arrange for introduction of County-sponsored legislation through the County legislative delegation (the state or federal elected officials who represent Contra Costa County).

IV. Process for Obtaining an Official County Position on Pending State and Federal Legislation

The process for obtaining an official County position on pending legislation is as follows:

- A. The County Administrator's Office shall subscribe to a legislative bill service, through which copies of all bills, resolutions, digests, and summaries are available, and shall make these materials available to county officials, employees, and advisory bodies as needed. Appropriate mechanisms will be developed by the County Administrator's Office to transmit these materials to the

various agencies and departments. Departments and agencies may also subscribe to a legislative service, as needed.

- B. County officials, employees, and advisory body members should seek to keep informed on legislation and regulation pertaining to functions under their supervision and should call to the attention of the County Administrator's Office the bills or regulations of particular importance to the County, with an analysis of potential impact on County operations and conformance with the County's adopted *Platforms*.
- C. In the analysis, the recommendation of the department, agency or advisory body should be stated, including, when appropriate, a recommendation for a formal County position. Position recommendations may include:
1. Support
 2. Support in Concept
 3. Support if Amended
 4. Oppose
 5. Oppose Unless Amended
 6. Watch
- D. The County Administrator's Office will review the recommendation for (1) potential impact on the County; and (2) policy conformance with the adopted *Platforms*. If there are interdepartmental or interagency impacts, the County Administrator's Office will work to achieve a consensus position among departments and/or agencies involved.
- E. After its review, the County Administrator's Office will make one of two determinations:
1. If the County's adopted *Platforms* contains a policy position or principle directly related to the pending legislation, action can be taken by the Chair of the Board, County Administrator, or designee of the Chair or County Administrator, in the form of a letter expressing the County's formal position.
 2. If the County's adopted *Platforms* does not contain a policy or principle directly related to the pending legislation, then formal Board of Supervisors action is required.
 - i. Staff should secure a recommendation of the Board's Legislation Committee (or relevant policy committee of the Board, seeking guidance from the CAO's office, as needed) prior to presentation to the Board of Supervisors; or

- ii. If the pending legislation is of critical importance, requires immediate action prior to the next Board meeting, and the Board Chair reasonably believes a majority of the Board would support such action, action may be taken by the Board Chair and the County Administrator in the form of a letter from the Board Chair, or designee.
 - iii. The County Administrator will seek the Board of Supervisors' ratification of such action at the next Board meeting or as soon as reasonably practicable.
- F. Generally, the County position on legislation will conform to, or at least will not conflict with, formal policy positions adopted by the California State Association of Counties (CSAC), the Urban Counties of California (UCC), or the National Association of Counties (NACo). The County Administrator will advise the Board of Supervisors in this regard and will communicate the County's formal positions on legislation to appropriate state or federal officials, including legislators, CSAC, UCC, and NACo.
- G. After the Board of Supervisors establishes the official County position on legislation and regulation, County officials and employees shall support that position when designated to represent the County.

V. Positions and Comments on Federal and State Rulemaking and State and Federal Budget Legislation:

On behalf of the Board of Supervisors and in consultation with the Board Chair, County departments/agencies, and County Counsel, the County Administrator, or designee, will submit comments on pending state and/or federal rulemaking and/or state and federal budget matters when:

1. Existing policy on the issue exists in the *Platforms* and affected County departments/agencies agree with the position;
2. There is no existing policy in the *Platforms* and the proposal is technical, non-controversial or the policy impacts are minor;
3. Action is needed immediately to ensure that the County's interests are protected; or
4. Action is needed to prevent modification or termination of an existing County program or policy.

In all such instances, the Board of Supervisors shall be informed of the actions taken on the County's behalf.

VI. Statewide Ballot Propositions and Local Ballot Measures:

The process for action on statewide and local ballot measures is as follows:

- a. Board members, the County Administrator, and department heads may request the Board take formal action on statewide or local ballot propositions of potential impact to the County.
- b. The County Administrator's Office will review and prepare for the Legislation Committee an impartial analysis of all ballot measures brought forward for action. The analysis shall include a copy of the ballot measure, sufficient information to understand the impacts on the County, a list of known support and opposition, and identification of existing County policy that relate to the recommended position or the new policy.
- c. The Legislation Committee of the Board shall consider the measure and make a recommendation for consideration by the Board of Supervisors.
- d. The Board of Supervisors shall consider the recommendation of the Committee sufficiently in advance of the election to enable the Board's action to be relevant, and to the extent possible, to enable the Board to postpone and reconsider the matter at a later Board meeting.

VII. Legislative Advocacy

It is the primary responsibility of the County Administrator's Office, in coordination with the County's legislative advocates in Sacramento and Washington, D.C., to advance official County positions on proposed legislation and regulations. This advocacy may involve the participation of Board Members, the County Administrator, department/agency heads, and other designated County staff as appropriate.

To maintain a presence in Sacramento and Washington, D.C., the County may contract for state and federal representation to advocate official County positions on pending state and federal legislation, County sponsored bills, administrative and regulatory proceedings, and funding requests.

A. Advocacy Efforts on Behalf of the County. The following procedures address appropriate advocacy efforts on behalf of County.

Note that no department/agency or advisory body shall take an action that would imply the County's support or opposition to any pending legislation and/or regulation in the absence of or inconsistent with an adopted Board position. Furthermore, no department/agency or advisory body shall send a letter or make a social media posting communicating a position on legislation or regulation that the CAO has not reviewed and approved.

1. Testimony in Support of County's Platforms

- a. The County Administrator, in conjunction with the County's legislative advocates, will provide for and coordinate the attendance of county officers and employees in Sacramento and Washington, D.C. in support of the adopted *Platforms*.
- b. County representatives will be designated by the County Administrator in advance to testify in support of the County position on legislation. The County's state or federal legislative advocate will arrange such appearances and testimony so that duplicate or conflicting testimony will be avoided. In general, members of the Board of Supervisors, the County Administrator's Office, department/agency heads, and the County's contract legislative advocates will represent the County in Sacramento and Washington, D.C. for the purpose of conveying the official County position and anticipated impact of measures.
- c. The County Administrator's Office may authorize County staff to advocate before the Legislature, legislative committees, and local or regional governmental bodies on policies consistent with the Board of Supervisors' position. Proposed testimony and related materials must be submitted to the County Administrator's Office in advance of testimony for review and coordination, as necessary.

2. Non-Advocacy Related Testimony

- a. When requests are received by a department or agency to present informational and/or expert testimony on an issue, rather than as an advocate, it is not necessary to provide a copy of the testimony to the County Administrator's Office for prior review. However, the County Administrator's Office must be notified in advance of the testimony.
- b. When a department or agency is requested to provide expert testimony about a subject on which the Board of Supervisors has no formal position, as determined by the County Administrator's Office, it is imperative that the person providing the testimony state for the record that they are providing testimony as an expert in the given field and not as a representative of the County.

3. Correspondence and Social Media Advocating a Position

- a. Following action by the Board of Supervisors on legislative and/or regulatory matters, or if action is contemplated by or consistent with the County's adopted *Platforms*, the County Administrator's Office or designee will coordinate with the Board Chair to send a letter communicating the Board's position to appropriate state and federal representatives, committees, and agencies.
- b. The County Administrator's Office will coordinate the preparation of position letters with departments and agencies in accordance with the adopted County positions and distributed by the County's legislative advocates.
- c. Social media use by County officials and employees to express the County's official position on pending state or federal legislation shall be consistent with the County's adopted *Platforms* and approved by the County Administrator's Office in advance of posting.

4. Other Contact with State and Federal Representatives

- a. County officials and employees planning trips to Sacramento or Washington, D.C. to meet with state or federal representatives, committees, and/or agencies must notify the County Administrator's Office of their intended appearance, specifying the general purpose of the visit and whom they plan to see.
- b. In the event that a meeting is scheduled between a County department/agency and any legislator, staff of legislator, or official of state and/or federal agencies, advance notice of the meetings shall be provided to the County Administrator's Office.
- c. Any written materials that are to be presented to a state or federal representative, committee, or agency of a legislative or policy nature shall be provided to the County Administrator's Office in advance of presentation. Elected officials are encouraged to provide their materials to the County Administrator's Office for awareness and coordination purposes.
- d. The County Administrator's Office must be informed of the outcomes of any meetings.

5. Professional Organizations' Requests for Advocacy

At times, professional organizations representing various functions of County departments/agencies may take a position on pending state or federal legislation and request letters of support/opposition or sign-on for that organization's position.

- a. Before preparing letters in support of the professional organization's position or signing on to "sign-on letters" by providing the County seal, County staff shall contact the County Administrator's Office to:
 - i. discuss the requested action and position of the organization,
 - ii. verify whether there is existing County policy or position on the issue, and
 - iii. verify that it does not conflict with adopted Board policy or adversely impact other County operations.

6. Advisory Boards and Commissions—Advocacy Activities

Some departments/agencies work directly with and coordinate activities with an advisory board or commission. If the advisory board or commission wishes for the Board of Supervisors to take a position on a measure, the chair of the advisory board or commission must work through their department/agency staff liaison to bring the matter to the attention of the County Administrator's Office for review and action. The County Administrator's Office will determine if there is County-adopted policy or position to take action or if the measure needs to be brought to the Board of Supervisors for action.

Advisory boards or commissions established by the Board of Supervisors *that are state or federally mandated*, shown on Attachment A, may engage in legislation position development and advocacy according to the following procedures:

- a. Positions may be taken only insofar as they are not inconsistent with Board-adopted policies or positions. Staff of the mandated advisory board or commission must review the position for consistency with the County's adopted *Platforms* and advise the advisory board or commission if an inconsistency exists; and
- b. Positions of the mandated advisory body or commission must be communicated in a manner that clearly states through the use of a disclaimer/disclosure on any stationery and in the body of the letter that the advisory body is advisory to the Board of Supervisors and that any comments, recommendations, opinions, and positions made by the board

or commission or its individual members do not represent the official position of the County or any of its officers; and

- c. Position letters must be distributed by the County Administrator's Office, who will include in its distribution the Board of Supervisors and any relevant Board committee.

B. Advocacy That Is Not on Behalf of the County

Nothing in this bulletin shall preclude officers and employees from taking a position different from the formal county position before the Legislature when they are acting in their outside capacities, such as when representing an association of county officers or a recognized employee organization, or when expressing a personal opinion.

Correspondence regarding legislation sent by **independently elected officials** must specify that they are issued in their own capacity and not on behalf of the County or Board of Supervisors.

In all such situations,

- 1) the officer or employee shall clearly indicate that they are not representing the County but rather some other agency or expressing a personal opinion;
- 2) the officer or employee shall not make representation in any way on behalf of the County;
- 3) Expenses and travel costs incurred will be at their own expense;
- 4) Time taken during working hours may be charged to vacation leave or to leave without pay and shall be subject to approval of the department head in each instance; and
- 5) Notification of the outside group's position to the County Administrator's Office is requested, especially when it may significantly impact the County's programs or operations.

VIII. Legislative and Regulatory Activity Coordination

In collaboration with the legislative advocates and County departments/agencies who may be delegated specific legislative policy areas (e.g., transportation, health care, and sustainability), the County Administrator's Office will coordinate the activities of the County related to legislation and regulation, including:

- A. Developing the *Platforms* for consideration and adoption by the Board of Supervisors.
- B. Serving as the "clearing house" for all official contacts in the name of the County by county officers and employees with state and federal legislators and officials. Official contacts on behalf of the County include:

1. Communication with legislators and administrative officials on legislative and regulatory matters. Unless specifically designated to Department staff by the County Administrator, correspondence emanating from the County will be transmitted via the County Administrator's Office and distributed via the County's state and federal legislative advocates.
2. Participation with legislators and administrative officials in drafting of bills, policies, and regulations which affect Contra Costa County.
3. Appearances to speak for Contra Costa County before legislative or congressional committees, including regular and interim committee hearings, special study commissions, and administrative hearings.

C. Providing Reports to the Board and Staff Support to the Legislation Committee.

The County Administrator's Office will track the progress of and maintain a list of all bills and measures on which the Board of Supervisors has adopted a formal position. This list will be maintained on the County Administrator's webpage. The County Administrator's Office will also provide staff support to the Board of Supervisors' Legislation Committee.

D. Coordinating State Lobbying Activity Reporting. As required by state law, lobbying activity undertaken by County officials and employees must be reported on a quarterly basis. On a quarterly basis, CAO staff will distribute to all departments/agencies electronic lobbying activity questionnaires for submittal.

"Lobbying" includes meeting with state legislators, agency officials and their staffs -- whether in person, by telephone, by email, or in writing -- on pending bills or regulations; working with the organization's registered lobbyist; monitoring pending bills or regulations; working with other companies, trade associations or community groups on state issues; developing grassroots lobbying pieces; ex parte contacts with regulatory agency officials; etc. "Lobbying" does not include working on state contracts, permits, or licenses; providing purely technical or ministerial information to state officials; or working on city, county or federal issues.

IX. Expense Reimbursement

Expense reimbursement, in accordance with the County expense reimbursement policy, is authorized when personnel must travel on official business in support of legislation, such as when representing the official position of the County or the official position of an association of county officials of which they are a member, (e.g., the County Auditors or County Clerks Association).

X. Application of Rules and Procedures

The rules and procedures as set forth in this bulletin shall apply to testimony and correspondence presented to regular and interim committees of the Legislature, as well as to testimony and correspondence presented to any special study commissions.

Monica Nino
County Administrator

Originating Department: County Administrator's Office

State or Federally Mandated Advisory Boards or Commissions Established by the Board of Supervisors

1	Advisory Council on Aging
2	Airport Land Use Commission
3	Assessment Appeals Board
4	CCC Law Library Board of Trustees
5	Economic Opportunity Council
6	Emergency Medical Care Committee
7	First 5 Contra Costa Children & Families Commission
8	Fish & Wildlife Committee
9	Hazardous Materials Commission
10	In-Home Supportive Services Public Authority Advisory Committee
11	Local Child Care & Development Planning Council
12	Managed Care Commission
13	Mental Health Commission
14	Merit Board
15	Planning Commission
16	Workforce Development Board



Contra
Costa
County

To: Board of Supervisors
From: Deborah R. Cooper, Clerk-Recorder
Date: March 8, 2022

Subject: Agreement for Polling Site in the City of Brentwood for April 5, 2022 Special Election

RECOMMENDATION(S):

APPROVE AND AUTHORIZE the Clerk-recorder, or designee, to execute a contract with the City of Brentwood at no costs to rent the Brentwood Community Center for the April 5, 2022 Assembly District 11 Special Election.

FISCAL IMPACT:

None.

BACKGROUND:

The Elections Division of the Clerk-Recorder's Office will provide 153 polling places throughout the County for the April 5, 2022 Special election. Sites that will be utilized include the Brentwood Community Center in the City of Brentwood. The Facility Rental Agreement and Use Agreement for this site contain an indemnification and hold harmless provision, whereby the County agrees to indemnify and hold harmless the City of Brentwood for use of this site as a voting location. For early voting and election day voting, as well as set up and take down of voting equipment, the agreement provides the County with use of the Brentwood Community Center from November 3, 2022 through November 9, 2022.

CONSEQUENCE OF NEGATIVE ACTION:

The Elections Office will not be able to use this site as a voting location.

APPROVE

OTHER

RECOMMENDATION OF CNTY ADMINISTRATOR

RECOMMENDATION OF BOARD COMMITTEE

Action of Board On: **03/08/2022** APPROVED AS RECOMMENDED OTHER

Clerks Notes:

VOTE OF SUPERVISORS

AYE: John Gioia, District I Supervisor
Candace Andersen, District II Supervisor
Diane Burgis, District III Supervisor
Karen Mitchoff, District IV Supervisor
Federal D. Glover, District V Supervisor

I hereby certify that this is a true and correct copy of an action taken and entered on the minutes of the Board of Supervisors on the date shown.

ATTESTED: March 8, 2022

Monica Nino, County Administrator and Clerk of the Board of Supervisors

By: Stacey M. Boyd, Deputy

Contact: Helen Nolan, 925-335-7808

cc:

ATTACHMENTS

Fee Waiver

Facility

Application



Fee Waiver/Fee Reduction Application

**Finance &
Information Systems**
Effective: February 2017

Request for: Fee Waiver___ Fee Reduction___ (Select One)

Please note: Normal service request procedures should be followed for standard services.

Date of Application: _____

Date of Event: _____

Please complete the following and submit to: _____ *(City Department)*

***City of Brentwood
150 City Park Way
Brentwood, CA 94513
925-516-5400***

1. Proposed Event Name: _____

2. Total Requested Funding and/or fee Amount: \$ _____
(include all fees/departments)

3. Have matching funds been secured for this event? Yes _____ No _____

4. Applicant Information:

Name of Organization/Agency: _____

Contact Name: _____

Mailing Address: _____

Street Address: _____

City: _____ State: _____ Zip: _____

Email Address: _____ Telephone: _____ Fax: _____

Business License #: _____ Nonprofit ID #: _____ (attach copy)

5. Does this event fall under one or more of the City Council Two Year Goals? If yes, please explain:

6. Have you or your organization previously requested and/or received any funding from the City? If yes, please provide any pertinent funding information:



Fee Waiver/Fee Reduction Application

**Finance &
Information Systems**
Effective: February 2017

7. Will promotional materials be created for this event? _____ Yes _____ No

8. Proposed Event Information:

- a. How will the requested funds be used? Describe, in detail, the proposed event. Clearly define any fee schedules that are applicable to this event. Identify if the proposed event is a new service, or extension of an existing one.

- b. Specify the proposed area (e.g., downtown), population or agency that will benefit from this program or event.

- c. What documentation/data/records support the need for this proposed event? Identify your data sources. Additional pages may be included, if needed.

Date of Application: _____

Required Attachments:

Please provide the required copies of the following: *(Please note: Applications without the following documents will not be reviewed for funding)*

Please label attachments A, B, etc.

- A. Names and home addresses of governing board; identify current board officers, etc. Homes addresses are required.
- B. Proof of Non-Profit Status as described in the Policy
- C. Hold harmless agreement - By signing this application you are also signing and agreeing to the Hold Harmless Agreement.



Fee Waiver/Fee Reduction Application

**Finance &
Information Systems**
Effective: February 2017

C. Hold Harmless Agreement

Fiscal Year _____

Applicant, Event Sponsor or Contractor shall hold harmless, defend and indemnify the City of Brentwood (City) and its officers, officials, employees and volunteers from and against any and all liability, loss, damage, expense, costs (including without limitation costs and fees of litigations) of every nature arising out of or in connection with Applicant, Event Sponsor or Contractor's performance of work hereunder or its failure to comply with any of its obligations contained in the agreement except such loss or damage with was caused by the sole negligence or willful misconduct of the City.

Signatures:

Applicant

Date

Name of Organization /Agency

Note: Applicants will be notified within fourteen (14) business days if the request for use of City funds will be granted.

=====

For City of Brentwood Use Only

Approved by: _____ Est. Amt. \$ _____
Director Date

Approved by: _____ Est. Amt. \$ _____
Director Date

Approved by: _____ Est. Amt. \$ _____
Director Date

Approved by: _____ Est. Amt. \$ _____
Director Date

Approved by: _____ Est. Amt. \$ _____
Director Date

Total Fees Waived: \$ _____ (NTE)



Parks and Recreation Office
 (925) 516-5444
 35 Oak Street, Brentwood, CA 94513
 brentwoodca.gov

Permit Number _____

Facility Rental Application

Applicant Information			
First Name	Last Name	Date of Birth	Gender: <input type="checkbox"/> M <input type="checkbox"/> F
Address	City	State	Zip Code
Primary Phone Number	Secondary Phone Number	Email Address	
Emergency Contact Name	Emergency Contact Relation	Emergency Contact Phone Number	
Organization Information (if applicable)			
Organization Name	Organization Phone Number	Organization Website	
Organization Address	City	State	Zip Code
Organization Email Address	Non-Profit? <input type="checkbox"/> Yes <input type="checkbox"/> No	<input type="checkbox"/> 501(c)(3) Documentation Provided	
Facility Requested (check all that apply)			
Community Center <input type="checkbox"/> Community Room A/B (330) <input type="checkbox"/> Conference Room B (25) <input type="checkbox"/> Community Room A (120) <input type="checkbox"/> Multipurpose Room A/B (160) <input type="checkbox"/> Community Room B (150) <input type="checkbox"/> Multipurpose Room A (60) <input type="checkbox"/> Conference Room A/B (80) <input type="checkbox"/> Multipurpose Room B (70) <input type="checkbox"/> Conference Room A (25) <input type="checkbox"/> Kitchen (10)	Senior Center <input type="checkbox"/> Main Hall (208) <input type="checkbox"/> Meeting Room (80) <input type="checkbox"/> Classroom (50) <input type="checkbox"/> Combo Room (130)	Library <input type="checkbox"/> Community Room* (60) *Only available: Wed: 10am-8pm Fri./Sat.: 10am-6pm	
Date(s) Requested			
Day of the week: <input type="checkbox"/> Sun <input type="checkbox"/> Mon <input type="checkbox"/> Tue <input type="checkbox"/> Wed <input type="checkbox"/> Thu <input type="checkbox"/> Fri <input type="checkbox"/> Sat <input type="checkbox"/> Sun		Month/Day/Year: _____	
Rental Start Time: (enter facility)	Function Start Time: (guests arrive)	Function End Time: (guests leave)	Rental End Time: (exit facility)
Note: No access to facility or storage of items before or after rental times.			
Type of Event:	Attendance:	Event Details:	
<input type="checkbox"/> Adult Birthday <input type="checkbox"/> Performance <input type="checkbox"/> Anniversary <input type="checkbox"/> School Dance <input type="checkbox"/> Banquet <input type="checkbox"/> Shower <input type="checkbox"/> Celebration of Life <input type="checkbox"/> Wedding <input type="checkbox"/> Fundraiser <input type="checkbox"/> Youth Birthday <input type="checkbox"/> Meeting <input type="checkbox"/> Other: _____	Total attendees: _____ (includes caterers, band, DJ, etc.) Attendees under 21: _____ (included in total attendees)	Will food be: <input type="checkbox"/> Served <input type="checkbox"/> Sold If the event is open to the public and food or beverage is being sold or given away, a CCC Environmental Health Temporary Food Permit is required. Will alcohol be: <input type="checkbox"/> Served <input type="checkbox"/> Sold If sold, and ABC Permit is required. Will an admission fee be charged? <input type="checkbox"/> Yes <input type="checkbox"/> No	
Liability, Medical Consent, and other Terms of Facility Use			
<p>Indemnification. The User hereby voluntarily agrees to indemnify, defend, and hold harmless the City of Brentwood (City) it's officials, officers, employees, agents, and volunteers from any liability for property damage, injuries, or death resulting from or in any way connected with use of City facilities. The Authorized Representatives and User do forever release and hold harmless the City from all claims or rights of action for damage which User may incur as a consequence of the use of the Facility. This waiver and release is applicable except to the extent caused by the City's sole negligence or willful misconduct.</p> <p>Medical Consent. In emergency situations, User hereby agrees to allow the City staff to consent to any medical treatment that medical personnel deem necessary for any attendees of User's facility rental or event. It is understood that no health or accident insurance is provided by the City. It is further understood that this Contract is binding on my heirs and assigns.</p> <p>Equipment. I agree to return equipment issued to me in as good condition as when received, except for normal wear and tear.</p> <p>Photo/Video Release. Authorized Representatives and Participant hereby agree that pictures or videos taken during the Facility rental may be used for future promotional purposes.</p> <p>Acceptance. My signature below constitutes acceptance of the conditions set forth above.</p>			
Signature: _____		Printed Name: _____ Date: _____	

1. Reservation of the Facility

Initial: _____

- a. Facility rental applications are accepted no more than 18 months in advance for Brentwood residents, and 12 months in advance for non-residents. Reservations for use of the facilities may be made by contacting the Parks & Recreation Department to schedule a contract appointment. At the contract appointment, a completed application must be submitted, along with a payment of rental deposit and non-refundable application fee.
- b. All rentals require a minimum of 2 hours, and must include any time for setup and cleanup. Refunds will not be given for any unused rental time.
- c. The City accepts the following forms of payment: check/money order; MasterCard, Visa, Discover, and cash. Payments for non-profit organizations or public agencies must be drawn on the organization or agency account.
- d. Reservations must be made at least 30 days prior to the event. Special requests of less than 30 days are considered on a case-by-case basis and an Application Rush Fee will be included.
- e. Renters must be a minimum of 18 years of age. If alcohol is being served, renter must be a minimum of 21 years of age. A photo I.D with the applicant's address and date of birth must be provided at the time of the reservation.
- f. Upon completion of the contract meeting and approval of application, the renter will sign the Facility Permit and be provided a Facility Renter Checklist outlining due dates for fees, various paperwork submittals, and facility walk through and floorplan meeting.
- g. The City reserves the right to book additional events/rentals before and after your event, and in other areas of the facility.
- h. All remaining fees are due 30 days prior to the event. For rentals less than 30 days, all fees are due upon booking of facility. Payment by check will not be accepted less than 30 days prior to the event and payment by credit card will not be accepted less than 14 days prior to the event.
- i. Once the rental permit has been issued, the renter has one opportunity to make any changes or modifications at no additional cost to the rental permit up to 60 days prior to the event date. Changes or modifications made after that one courtesy modification/change to the rental permit will assess an additional fee per request. City reserves the right to assess an additional fee per request, for any reservation changes made less than 60 days prior to the event.
- j. Any changes to the original submitted application must be in writing.
- k. A damage deposit is required for all facility rentals; \$250 for events without alcohol and \$500 for events serving alcohol. The renter will be billed for any additional expenses not covered by the damage deposit. The determination and assessment of additional charges shall be at the sole discretion of the City. The deposit will be returned within 30 days after facility use as long as there is no damage to the facility or any additional expenses incurred.

2. Cancellations

Initial: _____

- a. The City reserves the right to cancel, reschedule, suspend, and/or refuse to grant the use of its facilities to any person or group if such use violates the Brentwood Municipal Code/City Rules and Regulations or in case of emergency.
- b. 100% of rental fees are refunded if cancellations are made 6 months or more prior to your rental date, with the exception of the application fee and the cancellation processing fee.
- c. Cancellations less than 6 months, but more than 4 months prior to your rental date, 15% of your total deposit will be retained in addition to the application fee and the cancellation processing fee.

- d. Cancellations less than 4 months, but more than 1 month prior to your rental date, 25% of your total deposit will be retained in addition to the application fee and the cancellation processing fee.
- e. Cancellations less than 30 days prior to your rental, 40% of the entire rental fee is retained in the addition to the application fee and the cancellation processing fee.
- f. If applicant wishes to cancel their event, a written cancellation letter must be submitted.

3. Use of the Facility

Initial: _____

- a. The facility may be used by residents, non-residents, non-profit organizations and commercial groups, defined as follows:
 - i. Resident: an individual whose primary residence is within the City limits of Brentwood
 - ii. Non-Resident: an individual whose primary residence is outside the City limits of Brentwood
 - iii. Non-Profit: When use of the facility is by a non-profit organization as determined by the Internal Revenue Service and/or State of California with at least 75% of its membership made up of Brentwood residents, and the purpose of the use is to raise funds for community, charitable, or education projects within Brentwood or that benefits Brentwood residents. A copy of the letter granting the organization non-profit status from the Secretary of State's office is required to receive the non-profit rate.
 - iv. Commercial: when use of the facility is for profit or sale with proceeds to benefit an individual or organization.
- b. A minimum of one half hour is required for set-up and takedown of all rentals, although larger events may require more time depending on the size and scope of the event.
- c. After the facility has been used, it must be left in a clean and orderly condition. All equipment moved or borrowed must be returned to its original position and location.
- d. At all times the facility is being used, City staff shall be on duty to ensure the enforcement of these Rules & Regulations. The City reserves the right to close down or cancel any event that is in violation of any city ordinance. The City also reserves the right to close down or cancel the event if public safety, damage to the facility, behavior of the event guests, or affected department supervisors deem the event unsafe for public participation.
- e. The Renter signing the permit is responsible for any loss or damage to the property. The Renter must pay the City an amount equal to the cost of repair and/or replace the lost or damaged item.
- f. The Renter is responsible for the control and supervision of all guests, caterers, musicians, and other contracted service providers, and ensure that all adhere to the City's policies and procedures.
- g. Minors (any person under the age of 18) must be actively supervised at all times.
- h. City staff cannot sign for or receive deliveries. The Renter or a designated representative must be present to supervise and sign for all deliveries and pick-ups associated with their event.
- i. City staff will setup and take down tables and chairs, rented City equipment, and control lighting, audio/visual equipment, and heating and air conditioning.
- j. Equipment brought on site requires prior approval from the City (photo booths, backdrops, BBQs, audio visual equipment, ice sculptures, food truck, etc.) and must be removed immediately after the event. City staff will not store equipment and is not responsible for anything left in the facility. City staff reserves the right to remove any such equipment at the cost of the Renter. Additional charges may be assessed to the Renter for use of the facility beyond the specified rental contracted time. The determination of assessment will be at the sole discretion of the City and will be taken from the Renter's deposit.
- k. The facility maximum capacities are strictly enforced. The maximum capacity for an event includes all adults and children,

including caterers, DJ's, bands, party planners, etc. Violation of the capacity limits will result in immediate termination of the event and forfeiture of some or all of the facility deposit.

- l. No rice, birdseed, confetti, glitter, rose petals, or sand may be thrown inside or outside of the facility.
- m. Smoking of any kind is prohibited in any City facility or within 20 feet of entrance or exit per State of California law (State Code 7596-7598).
- m. All City furniture must stay inside the facility. Any furniture brought in by the Renter (chairs, sofas, tables, light bars, etc.) must have padded or protected feet.
- n. Use of nails, tacks, scotch tape, staples, etc., is strictly prohibited. Only painters tape may be used to attach items to walls. Gaffer tape may be used on the floor.
- o. At no time shall exits or exit signs be covered or obstructed.
- p. The City will not supply ladders, extension cords, scissors, tape or paper for use. Renter must provide supplies, if necessary.
- q. Electrical outlets are limited to 20 amps.
- r. Mylar/foil balloons with helium are prohibited, however air-filled Mylar/foil balloons are permitted.
- s. All decorations must be fire proofed or made of fire retardant materials. Candles are permitted only in holders in which the flame is not exposed (except on cakes). Open flames such as gas burners, candles and butter warmers (with the exception of Sterno-type cups) are not allowed inside the facility.
- t. Fog machines, smoke machines, and hazers are not permitted.
- u. Barbecues, grills, and griddles are permitted only with advance approval and in designated areas.
- v. All decorations must be removed before the premise is vacated.
- w. Parking is available on nearby streets and City parking lots/structure, but is not guaranteed.
- x. Equipment and decorations not listed above requires written approval from City staff.

4. Alcohol

Initial: _____

- a. If alcohol is going to be served or sold, it must be indicated on the rental application and permit.
- b. Alcoholic beverages, if allowed, are the responsibility and liability of the Renter and/or organization renting the facility.
- c. Presence and/or the consumption of any and all alcoholic beverages shall be prohibited except by permit, and only consumed during the event time indicated on the permit.
- d. Alcoholic beverages must be served from a controlled bar by a person over 21 years old and must be served with food. The serving alcohol must end 30 minutes before the conclusion of the event.
- e. To sell alcoholic beverages at your event, a valid alcohol permit from the California Department of Alcoholic Beverage Control (A.B.C.), must be obtained. Events involving the exchange of monetary consideration (example: purchase of meal or meal ticket with any form of alcohol being served as part of the meal) also require a California Department of Alcoholic Beverage Control (A.B.C.) permit. A.B.C. will issue one-day permits to 501(c)3 non-profit groups who wish to sell admission tickets, beer, wine or distilled spirits at a fundraising event. A.B.C. applications are available at the Parks and Recreation office and it is the renter's responsibility to complete and submit the application to A.B.C. (located at Elihn M. Harris State Office Bldg. 1515 Clay Street, Suite 2208, Oakland, CA 94612, (510) 622-4970).
- f. Alcohol permit must be on file in the Parks and Recreation Office 14 days prior to your event. Alcohol permit must be prominently displayed during your event. City staff is required to check your license prior to allowing the sale or distribution of alcohol at the event.

- g. Violation of any of these requirements will result in immediate termination of Renter's event and will result in forfeiture of the damage deposit.

5. Security Guards

Initial: _____

- a. Security guards may be required to be on duty during the event. The Brentwood Police Department will determine if security guards are necessary and the number of guards required at the event. The renter is responsible to pay for these services. Security guards must be present at the times stated on the Brentwood Police Department's Conditions of Approval letter.
- b. Security guard companies must be registered and approved by the Brentwood Police Department and must have a valid City of Brentwood business license. City will provide you a list of approved companies and the renter can select and reserve a company from the list.
- c. The Renter has direction over security guard duties.

6. Insurance

Initial: _____

- a. Renters are responsible for providing insurance. The Renter is accountable financially for any and all accidents or injuries to persons or property resulting from their use of City facilities.
- b. Renters may use their own insurance provided that the policy meets minimum standards (City staff will provide information if choosing this option).
- c. If you are unable to provide this certificate through your homeowners' insurance, you may purchase special event insurance through the City.



Facility Rental Rules & Regulations

City of Brentwood Parks & Recreation

Cleanup Agreement

The Renter agrees to walk the facility, including restrooms, kitchen and rooms reserved with facility staff prior to and after the event to review any current or new damage to the facility that may have occurred during the rental.

The Renter agrees to perform the following:

- a. Pick-up and discard/remove all decorations (e.g. table coverings, wall décor, centerpieces, balloons, etc.)
- b. Pick up all trash, both inside and outside, and place in lined trashcans provided.
- c. Ensure caterers clean kitchen area (i.e. stoves, counters, sinks, remove all items from the refrigerator, etc.)
- d. Report all spills to facility staff immediately for cleanup and allow staff access to area.
- e. Remove all equipment brought in for the event by the rental end time (i.e. by the DJ, decorator, caterer, etc.)
- f. Leave walls, floors, and restrooms undamaged.

By signing below, I agree that at the conclusion of my event I will leave the facility in the same condition as when the event began. I further understand that non-compliance to this Agreement will result in the forfeiture of some, if not all, of my deposit, as well as I may be invoiced for any additional cost to provide for the clean up of my event.

Signature: _____ Printed Name: _____ Date: _____



Facility Rental Rules & Regulations

City of Brentwood Parks & Recreation

Facility Rental Checklist

Initial each item:

_____ I have had the opportunity to read the Rules & Regulations and received a copy.

_____ I will be in attendance throughout the event and I am responsible for the conduct and control of the group.
Children under the age of 18 must be supervised at all times

_____ I have reviewed the rules about decorations.

_____ Facility Walk-Through: I agree to walk through the rented area(s) with City staff before and after the event
(no one will be allowed in the facility before the walk-through.)

_____ The maximum number of people (including guests, DJ/band, caterers, etc.) allowed at my event is _____.
It is my responsibility to control the number of people admitted and not allow more than capacity.

_____ Insurance criteria reviewed. Purchase from City Provide own insurance and endorsement

_____ Security services criteria reviewed.

_____ All contract modifications must be in writing. Additional fees may apply.

_____ Fees must be paid 30 days prior to my rental date or I risk cancellation of my event. (No checks will be accepted for payments made less than 30 days before the rental date. Only cash will be accepted for payments made less than 14 days before the rental date.)

_____ Proof of security guards services, alcohol permit, and/or health permit must be submitted 14 days prior to the rental date (if applicable).

_____ All paperwork, fees, and insurance are due on _____.

Signature: _____ Printed Name: _____ Date: _____

Instructions for Completing Certificate of Insurance for Facility Rentals

Please send this list to your insurance company or broker

Items below **MUST** be included on your Certificate of Insurance:

- General Liability Insurance Coverage \$1,000,000 CSL
- The name of the insured must match the name and address of the applicant on the Facility Rental Application.
- Event/Facility Rental Date
- Full name of company(s) affording coverage on the Certificate of Insurance.
- Authorized Representative's original signature

Separate endorsement form for General Liability must contain the following:

- The City of Brentwood, its officers, agents, volunteers and employees must be named as an additional insured with respect to liability arising out of activities performed by or on behalf of the Named Insured.
- Coverage under this policy shall be primary insurance as respects the City of Brentwood, its officers, agents, volunteers and employees.
- All rights of subrogation are waived as respects all additional insureds hereunder.

Please mail the Certificate of Insurance, with endorsements to:
City of Brentwood, Parks and Recreation Department, 150 City Park Way, Brentwood, CA 94513

Additional Insured Endorsement MUST read:

City of Brentwood, its officers, agents, volunteers and employees
150 City Park Way
Brentwood, CA 94513



Contra
Costa
County

To: Board of Supervisors
From: Deborah R. Cooper, Clerk-Recorder
Date: March 8, 2022

Subject: Agreement for Polling Site in the City of Brentwood for June 7, 2022 Primary Election

RECOMMENDATION(S):

APPROVE AND AUTHORIZE the Clerk-recorder, or designee, to execute a contract with the City of Brentwood at no costs to rent the Brentwood Community Center for the June 7, 2022 Gubernatorial Primary Election.

FISCAL IMPACT:

None.

BACKGROUND:

The Elections Division of the Clerk-Recorder's Office will provide 153 polling places throughout the County for the June 7, 2022 Gubernatorial Primary Election. Sites that will be utilized include the Brentwood Community Center in the City of Brentwood. The Facility Rental Agreement and Use Agreement for this site contains an indemnification and hold harmless provision, whereby the County agrees to indemnify and hold harmless the City of Brentwood for use of this site as a voting location. For early voting and election day voting, as well as set up and take down of voting equipment, the agreement provides the County with use of the Brentwood Community Center from June 2 through June 8, 2022.

CONSEQUENCE OF NEGATIVE ACTION:

The Elections Office will not be able to use this site as a voting location.

APPROVE

OTHER

RECOMMENDATION OF CNTY ADMINISTRATOR

RECOMMENDATION OF BOARD COMMITTEE

Action of Board On: **03/08/2022** APPROVED AS RECOMMENDED OTHER

Clerks Notes:

VOTE OF SUPERVISORS

AYE: John Gioia, District I Supervisor
Candace Andersen, District II Supervisor
Diane Burgis, District III Supervisor
Karen Mitchoff, District IV Supervisor
Federal D. Glover, District V Supervisor

I hereby certify that this is a true and correct copy of an action taken and entered on the minutes of the Board of Supervisors on the date shown.

ATTESTED: March 8, 2022

Monica Nino, County Administrator and Clerk of the Board of Supervisors

By: Stacey M. Boyd, Deputy

Contact: Helen Nolan, 925-335-7808

cc:

ATTACHMENTS

Fee Waiver

Facility

Application



Fee Waiver/Fee Reduction Application

**Finance &
Information Systems**
Effective: February 2017

Request for: Fee Waiver ___ Fee Reduction ___ (Select One)

Please note: Normal service request procedures should be followed for standard services.

Date of Application: _____

Date of Event: _____

Please complete the following and submit to: _____ *(City Department)*

***City of Brentwood
150 City Park Way
Brentwood, CA 94513
925-516-5400***

1. Proposed Event Name: _____

2. Total Requested Funding and/or fee Amount: \$ _____
(include all fees/departments)

3. Have matching funds been secured for this event? Yes _____ No _____

4. Applicant Information:

Name of Organization/Agency: _____

Contact Name: _____

Mailing Address: _____

Street Address: _____

City: _____ State: _____ Zip: _____

Email Address: _____ Telephone: _____ Fax: _____

Business License #: _____ Nonprofit ID #: _____ (attach copy)

5. Does this event fall under one or more of the City Council Two Year Goals? If yes, please explain:

6. Have you or your organization previously requested and/or received any funding from the City? If yes, please provide any pertinent funding information:



Fee Waiver/Fee Reduction Application

**Finance &
Information Systems**
Effective: February 2017

7. Will promotional materials be created for this event? _____ Yes _____ No

8. Proposed Event Information:

- a. How will the requested funds be used? Describe, in detail, the proposed event. Clearly define any fee schedules that are applicable to this event. Identify if the proposed event is a new service, or extension of an existing one.

- b. Specify the proposed area (e.g., downtown), population or agency that will benefit from this program or event.

- c. What documentation/data/records support the need for this proposed event? Identify your data sources. Additional pages may be included, if needed.

Date of Application: _____

Required Attachments:

Please provide the required copies of the following: *(Please note: Applications without the following documents will not be reviewed for funding)*

Please label attachments A, B, etc.

- A. Names and home addresses of governing board; identify current board officers, etc. Homes addresses are required.
- B. Proof of Non-Profit Status as described in the Policy
- C. Hold harmless agreement - By signing this application you are also signing and agreeing to the Hold Harmless Agreement.



Fee Waiver/Fee Reduction Application

**Finance &
Information Systems**
Effective: February 2017

C. Hold Harmless Agreement

Fiscal Year _____

Applicant, Event Sponsor or Contractor shall hold harmless, defend and indemnify the City of Brentwood (City) and its officers, officials, employees and volunteers from and against any and all liability, loss, damage, expense, costs (including without limitation costs and fees of litigations) of every nature arising out of or in connection with Applicant, Event Sponsor or Contractor's performance of work hereunder or its failure to comply with any of its obligations contained in the agreement except such loss or damage with was caused by the sole negligence or willful misconduct of the City.

Signatures:

Applicant

Date

Name of Organization /Agency

Note: Applicants will be notified within fourteen (14) business days if the request for use of City funds will be granted.

=====

For City of Brentwood Use Only

Approved by: _____ Est. Amt. \$ _____
Director Date

Approved by: _____ Est. Amt. \$ _____
Director Date

Approved by: _____ Est. Amt. \$ _____
Director Date

Approved by: _____ Est. Amt. \$ _____
Director Date

Approved by: _____ Est. Amt. \$ _____
Director Date

Total Fees Waived: \$ _____ (NTE)



Parks and Recreation Office
 (925) 516-5444
 35 Oak Street, Brentwood, CA 94513
 brentwoodca.gov

Permit Number _____

Facility Rental Application

Applicant Information

First Name	Last Name	Date of Birth	Gender: <input type="checkbox"/> M <input type="checkbox"/> F
Address	City	State	Zip Code
Primary Phone Number	Secondary Phone Number	Email Address	
Emergency Contact Name	Emergency Contact Relation	Emergency Contact Phone Number	

Organization Information (if applicable)

Organization Name	Organization Phone Number	Organization Website	
Organization Address	City	State	Zip Code
Organization Email Address	Non-Profit? <input type="checkbox"/> Yes <input type="checkbox"/> No	<input type="checkbox"/> 501(c)(3) Documentation Provided	

Facility Requested (check all that apply)

Community Center <input type="checkbox"/> Community Room A/B (330) <input type="checkbox"/> Conference Room B (25) <input type="checkbox"/> Community Room A (120) <input type="checkbox"/> Multipurpose Room A/B (160) <input type="checkbox"/> Community Room B (150) <input type="checkbox"/> Multipurpose Room A (60) <input type="checkbox"/> Conference Room A/B (80) <input type="checkbox"/> Multipurpose Room B (70) <input type="checkbox"/> Conference Room A (25) <input type="checkbox"/> Kitchen (10)	Senior Center <input type="checkbox"/> Main Hall (208) <input type="checkbox"/> Meeting Room (80) <input type="checkbox"/> Classroom (50) <input type="checkbox"/> Combo Room (130)	Library <input type="checkbox"/> Community Room* (60) *Only available: Wed: 10am-8pm Fri./Sat.: 10am-6pm
---	--	---

Date(s) Requested

Day of the week: Sun Mon Tue Wed Thu Fri Sat Sun Month/Day/Year: _____

Rental Start Time: (enter facility)	Function Start Time: (guests arrive)	Function End Time: (guests leave)	Rental End Time: (exit facility)
--	---	--------------------------------------	-------------------------------------

Note: No access to facility or storage of items before or after rental times.

Type of Event:	Attendance:	Event Details:
<input type="checkbox"/> Adult Birthday <input type="checkbox"/> Performance <input type="checkbox"/> Anniversary <input type="checkbox"/> School Dance <input type="checkbox"/> Banquet <input type="checkbox"/> Shower <input type="checkbox"/> Celebration of Life <input type="checkbox"/> Wedding <input type="checkbox"/> Fundraiser <input type="checkbox"/> Youth Birthday <input type="checkbox"/> Meeting <input type="checkbox"/> Other: _____	Total attendees: _____ (includes caterers, band, DJ, etc.) Attendees under 21: _____ (included in total attendees)	Will food be: <input type="checkbox"/> Served <input type="checkbox"/> Sold If the event is open to the public and food or beverage is being sold or given away, a CCC Environmental Health Temporary Food Permit is required. Will alcohol be: <input type="checkbox"/> Served <input type="checkbox"/> Sold If sold, and ABC Permit is required. Will an admission fee be charged? <input type="checkbox"/> Yes <input type="checkbox"/> No

Liability, Medical Consent, and other Terms of Facility Use

Indemnification. The User hereby voluntarily agrees to indemnify, defend, and hold harmless the City of Brentwood (City) it's officials, officers, employees, agents, and volunteers from any liability for property damage, injuries, or death resulting from or in any way connected with use of City facilities. The Authorized Representatives and User do forever release and hold harmless the City from all claims or rights of action for damage which User may incur as a consequence of the use of the Facility. This waiver and release is applicable except to the extent caused by the City's sole negligence or willful misconduct.

Medical Consent. In emergency situations, User hereby agrees to allow the City staff to consent to any medical treatment that medical personnel deem necessary for any attendees of User's facility rental or event. It is understood that no health or accident insurance is provided by the City. It is further understood that this Contract is binding on my heirs and assigns.

Equipment. I agree to return equipment issued to me in as good condition as when received, except for normal wear and tear.

Photo/Video Release. Authorized Representatives and Participant hereby agree that pictures or videos taken during the Facility rental may be used for future promotional purposes.

Acceptance. My signature below constitutes acceptance of the conditions set forth above.

Signature: _____ Printed Name: _____ Date: _____

1. Reservation of the Facility

Initial: _____

- a. Facility rental applications are accepted no more than 18 months in advance for Brentwood residents, and 12 months in advance for non-residents. Reservations for use of the facilities may be made by contacting the Parks & Recreation Department to schedule a contract appointment. At the contract appointment, a completed application must be submitted, along with a payment of rental deposit and non-refundable application fee.
- b. All rentals require a minimum of 2 hours, and must include any time for setup and cleanup. Refunds will not be given for any unused rental time.
- c. The City accepts the following forms of payment: check/money order; MasterCard, Visa, Discover, and cash. Payments for non-profit organizations or public agencies must be drawn on the organization or agency account.
- d. Reservations must be made at least 30 days prior to the event. Special requests of less than 30 days are considered on a case-by-case basis and an Application Rush Fee will be included.
- e. Renters must be a minimum of 18 years of age. If alcohol is being served, renter must be a minimum of 21 years of age. A photo I.D with the applicant's address and date of birth must be provided at the time of the reservation.
- f. Upon completion of the contract meeting and approval of application, the renter will sign the Facility Permit and be provided a Facility Renter Checklist outlining due dates for fees, various paperwork submittals, and facility walk through and floorplan meeting.
- g. The City reserves the right to book additional events/rentals before and after your event, and in other areas of the facility.
- h. All remaining fees are due 30 days prior to the event. For rentals less than 30 days, all fees are due upon booking of facility. Payment by check will not be accepted less than 30 days prior to the event and payment by credit card will not be accepted less than 14 days prior to the event.
- i. Once the rental permit has been issued, the renter has one opportunity to make any changes or modifications at no additional cost to the rental permit up to 60 days prior to the event date. Changes or modifications made after that one courtesy modification/change to the rental permit will assess an additional fee per request. City reserves the right to assess an additional fee per request, for any reservation changes made less than 60 days prior to the event.
- j. Any changes to the original submitted application must be in writing.
- k. A damage deposit is required for all facility rentals; \$250 for events without alcohol and \$500 for events serving alcohol. The renter will be billed for any additional expenses not covered by the damage deposit. The determination and assessment of additional charges shall be at the sole discretion of the City. The deposit will be returned within 30 days after facility use as long as there is no damage to the facility or any additional expenses incurred.

2. Cancellations

Initial: _____

- a. The City reserves the right to cancel, reschedule, suspend, and/or refuse to grant the use of its facilities to any person or group if such use violates the Brentwood Municipal Code/City Rules and Regulations or in case of emergency.
- b. 100% of rental fees are refunded if cancellations are made 6 months or more prior to your rental date, with the exception of the application fee and the cancellation processing fee.
- c. Cancellations less than 6 months, but more than 4 months prior to your rental date, 15% of your total deposit will be retained in addition to the application fee and the cancellation processing fee.

- d. Cancellations less than 4 months, but more than 1 month prior to your rental date, 25% of your total deposit will be retained in addition to the application fee and the cancellation processing fee.
- e. Cancellations less than 30 days prior to your rental, 40% of the entire rental fee is retained in the addition to the application fee and the cancellation processing fee.
- f. If applicant wishes to cancel their event, a written cancellation letter must be submitted.

3. Use of the Facility

Initial: _____

- a. The facility may be used by residents, non-residents, non-profit organizations and commercial groups, defined as follows:
 - i. Resident: an individual whose primary residence is within the City limits of Brentwood
 - ii. Non-Resident: an individual whose primary residence is outside the City limits of Brentwood
 - iii. Non-Profit: When use of the facility is by a non-profit organization as determined by the Internal Revenue Service and/or State of California with at least 75% of its membership made up of Brentwood residents, and the purpose of the use is to raise funds for community, charitable, or education projects within Brentwood or that benefits Brentwood residents. A copy of the letter granting the organization non-profit status from the Secretary of State's office is required to receive the non-profit rate.
 - iv. Commercial: when use of the facility is for profit or sale with proceeds to benefit an individual or organization.
- b. A minimum of one half hour is required for set-up and takedown of all rentals, although larger events may require more time depending on the size and scope of the event.
- c. After the facility has been used, it must be left in a clean and orderly condition. All equipment moved or borrowed must be returned to its original position and location.
- d. At all times the facility is being used, City staff shall be on duty to ensure the enforcement of these Rules & Regulations. The City reserves the right to close down or cancel any event that is in violation of any city ordinance. The City also reserves the right to close down or cancel the event if public safety, damage to the facility, behavior of the event guests, or affected department supervisors deem the event unsafe for public participation.
- e. The Renter signing the permit is responsible for any loss or damage to the property. The Renter must pay the City an amount equal to the cost of repair and/or replace the lost or damaged item.
- f. The Renter is responsible for the control and supervision of all guests, caterers, musicians, and other contracted service providers, and ensure that all adhere to the City's policies and procedures.
- g. Minors (any person under the age of 18) must be actively supervised at all times.
- h. City staff cannot sign for or receive deliveries. The Renter or a designated representative must be present to supervise and sign for all deliveries and pick-ups associated with their event.
- i. City staff will setup and take down tables and chairs, rented City equipment, and control lighting, audio/visual equipment, and heating and air conditioning.
- j. Equipment brought on site requires prior approval from the City (photo booths, backdrops, BBQs, audio visual equipment, ice sculptures, food truck, etc.) and must be removed immediately after the event. City staff will not store equipment and is not responsible for anything left in the facility. City staff reserves the right to remove any such equipment at the cost of the Renter. Additional charges may be assessed to the Renter for use of the facility beyond the specified rental contracted time. The determination of assessment will be at the sole discretion of the City and will be taken from the Renter's deposit.
- k. The facility maximum capacities are strictly enforced. The maximum capacity for an event includes all adults and children,

including caterers, DJ's, bands, party planners, etc. Violation of the capacity limits will result in immediate termination of the event and forfeiture of some or all of the facility deposit.

- l. No rice, birdseed, confetti, glitter, rose petals, or sand may be thrown inside or outside of the facility.
- m. Smoking of any kind is prohibited in any City facility or within 20 feet of entrance or exit per State of California law (State Code 7596-7598).
- m. All City furniture must stay inside the facility. Any furniture brought in by the Renter (chairs, sofas, tables, light bars, etc.) must have padded or protected feet.
- n. Use of nails, tacks, scotch tape, staples, etc., is strictly prohibited. Only painters tape may be used to attach items to walls. Gaffer tape may be used on the floor.
- o. At no time shall exits or exit signs be covered or obstructed.
- p. The City will not supply ladders, extension cords, scissors, tape or paper for use. Renter must provide supplies, if necessary.
- q. Electrical outlets are limited to 20 amps.
- r. Mylar/foil balloons with helium are prohibited, however air-filled Mylar/foil balloons are permitted.
- s. All decorations must be fire proofed or made of fire retardant materials. Candles are permitted only in holders in which the flame is not exposed (except on cakes). Open flames such as gas burners, candles and butter warmers (with the exception of Sterno-type cups) are not allowed inside the facility.
- t. Fog machines, smoke machines, and hazers are not permitted.
- u. Barbecues, grills, and griddles are permitted only with advance approval and in designated areas.
- v. All decorations must be removed before the premise is vacated.
- w. Parking is available on nearby streets and City parking lots/structure, but is not guaranteed.
- x. Equipment and decorations not listed above requires written approval from City staff.

4. Alcohol

Initial: _____

- a. If alcohol is going to be served or sold, it must be indicated on the rental application and permit.
- b. Alcoholic beverages, if allowed, are the responsibility and liability of the Renter and/or organization renting the facility.
- c. Presence and/or the consumption of any and all alcoholic beverages shall be prohibited except by permit, and only consumed during the event time indicated on the permit.
- d. Alcoholic beverages must be served from a controlled bar by a person over 21 years old and must be served with food. The serving alcohol must end 30 minutes before the conclusion of the event.
- e. To sell alcoholic beverages at your event, a valid alcohol permit from the California Department of Alcoholic Beverage Control (A.B.C.), must be obtained. Events involving the exchange of monetary consideration (example: purchase of meal or meal ticket with any form of alcohol being served as part of the meal) also require a California Department of Alcoholic Beverage Control (A.B.C.) permit. A.B.C. will issue one-day permits to 501(c)3 non-profit groups who wish to sell admission tickets, beer, wine or distilled spirits at a fundraising event. A.B.C. applications are available at the Parks and Recreation office and it is the renter's responsibility to complete and submit the application to A.B.C. (located at Elihn M. Harris State Office Bldg. 1515 Clay Street, Suite 2208, Oakland, CA 94612, (510) 622-4970).
- f. Alcohol permit must be on file in the Parks and Recreation Office 14 days prior to your event. Alcohol permit must be prominently displayed during your event. City staff is required to check your license prior to allowing the sale or distribution of alcohol at the event.

- g. Violation of any of these requirements will result in immediate termination of Renter's event and will result in forfeiture of the damage deposit.

5. Security Guards

Initial: _____

- a. Security guards may be required to be on duty during the event. The Brentwood Police Department will determine if security guards are necessary and the number of guards required at the event. The renter is responsible to pay for these services. Security guards must be present at the times stated on the Brentwood Police Department's Conditions of Approval letter.
- b. Security guard companies must be registered and approved by the Brentwood Police Department and must have a valid City of Brentwood business license. City will provide you a list of approved companies and the renter can select and reserve a company from the list.
- c. The Renter has direction over security guard duties.

6. Insurance

Initial: _____

- a. Renters are responsible for providing insurance. The Renter is accountable financially for any and all accidents or injuries to persons or property resulting from their use of City facilities.
- b. Renters may use their own insurance provided that the policy meets minimum standards (City staff will provide information if choosing this option).
- c. If you are unable to provide this certificate through your homeowners' insurance, you may purchase special event insurance through the City.



Facility Rental Rules & Regulations

City of Brentwood Parks & Recreation

Cleanup Agreement

The Renter agrees to walk the facility, including restrooms, kitchen and rooms reserved with facility staff prior to and after the event to review any current or new damage to the facility that may have occurred during the rental.

The Renter agrees to perform the following:

- a. Pick-up and discard/remove all decorations (e.g. table coverings, wall décor, centerpieces, balloons, etc.)
- b. Pick up all trash, both inside and outside, and place in lined trashcans provided.
- c. Ensure caterers clean kitchen area (i.e. stoves, counters, sinks, remove all items from the refrigerator, etc.)
- d. Report all spills to facility staff immediately for cleanup and allow staff access to area.
- e. Remove all equipment brought in for the event by the rental end time (i.e. by the DJ, decorator, caterer, etc.)
- f. Leave walls, floors, and restrooms undamaged.

By signing below, I agree that at the conclusion of my event I will leave the facility in the same condition as when the event began. I further understand that non-compliance to this Agreement will result in the forfeiture of some, if not all, of my deposit, as well as I may be invoiced for any additional cost to provide for the clean up of my event.

Signature: _____ Printed Name: _____ Date: _____



Facility Rental Rules & Regulations

City of Brentwood Parks & Recreation

Facility Rental Checklist

Initial each item:

_____ I have had the opportunity to read the Rules & Regulations and received a copy.

_____ I will be in attendance throughout the event and I am responsible for the conduct and control of the group.
Children under the age of 18 must be supervised at all times

_____ I have reviewed the rules about decorations.

_____ Facility Walk-Through: I agree to walk through the rented area(s) with City staff before and after the event
(no one will be allowed in the facility before the walk-through.)

_____ The maximum number of people (including guests, DJ/band, caterers, etc.) allowed at my event is _____.
It is my responsibility to control the number of people admitted and not allow more than capacity.

_____ Insurance criteria reviewed. Purchase from City Provide own insurance and endorsement

_____ Security services criteria reviewed.

_____ All contract modifications must be in writing. Additional fees may apply.

_____ Fees must be paid 30 days prior to my rental date or I risk cancellation of my event. (No checks will be accepted for payments made less than 30 days before the rental date. Only cash will be accepted for payments made less than 14 days before the rental date.)

_____ Proof of security guards services, alcohol permit, and/or health permit must be submitted 14 days prior to the rental date (if applicable).

_____ All paperwork, fees, and insurance are due on _____.

Signature: _____ Printed Name: _____ Date: _____

Instructions for Completing Certificate of Insurance for Facility Rentals

Please send this list to your insurance company or broker

Items below MUST be included on your Certificate of Insurance:

- General Liability Insurance Coverage \$1,000,000 CSL
- The name of the insured must match the name and address of the applicant on the Facility Rental Application.
- Event/Facility Rental Date
- Full name of company(s) affording coverage on the Certificate of Insurance.
- Authorized Representative's original signature

Separate endorsement form for General Liability must contain the following:

- The City of Brentwood, its officers, agents, volunteers and employees must be named as an additional insured with respect to liability arising out of activities performed by or on behalf of the Named Insured.
- Coverage under this policy shall be primary insurance as respects the City of Brentwood, its officers, agents, volunteers and employees.
- All rights of subrogation are waived as respects all additional insureds hereunder.

Please mail the Certificate of Insurance, with endorsements to:
City of Brentwood, Parks and Recreation Department, 150 City Park Way, Brentwood, CA 94513

Additional Insured Endorsement MUST read:

City of Brentwood, its officers, agents, volunteers and employees
150 City Park Way
Brentwood, CA 94513



Contra
Costa
County

To: Board of Supervisors
From: Deborah R. Cooper, Clerk-Recorder
Date: March 8, 2022

Subject: Agreement for Polling Site in the City of Brentwood for November 8, 2022 General Election

RECOMMENDATION(S):

APPROVE AND AUTHORIZE the Clerk-Recorder, or designee, to execute a contract with the City of Brentwood at no cost to rent the Brentwood Community Center for the November 8, 2022 Consolidated General Election.

FISCAL IMPACT:

None.

BACKGROUND:

The Elections Division of the Clerk-Recorder's Office will provide 153 polling places throughout the County for the November 8, 2022, Consolidated General Election. Sites that will be utilized include the Brentwood Community Center in the City of Brentwood. The Facility Rental Agreement and Use Agreement for this site contains an indemnification and hold harmless provision, whereby the County agrees to indemnify and hold harmless the City of Brentwood for use of this site as a voting location. For early voting and election day voting, as well as set up and take down of voting equipment, the agreement provides the County with use of the Brentwood Community Center from November 3, 2022 through November 9, 2022.

APPROVE

OTHER

RECOMMENDATION OF CNTY ADMINISTRATOR

RECOMMENDATION OF BOARD COMMITTEE

Action of Board On: **03/08/2022** APPROVED AS RECOMMENDED OTHER

Clerks Notes:

VOTE OF SUPERVISORS

AYE: John Gioia, District I Supervisor
Candace Andersen, District II Supervisor
Diane Burgis, District III Supervisor
Karen Mitchoff, District IV Supervisor
Federal D. Glover, District V Supervisor

I hereby certify that this is a true and correct copy of an action taken and entered on the minutes of the Board of Supervisors on the date shown.

ATTESTED: March 8, 2022

Monica Nino, County Administrator and Clerk of the Board of Supervisors

By: Stacey M. Boyd, Deputy

Contact: Helen Nolan, 925-335-7808

cc:

CONSEQUENCE OF NEGATIVE ACTION:

The Elections Office will not be able to use this site as a voting location.

ATTACHMENTS

Fee Waiver

Facility Application



Fee Waiver/Fee Reduction Application

**Finance &
Information Systems**
Effective: February 2017

Request for: Fee Waiver ___ Fee Reduction ___ (Select One)

Please note: Normal service request procedures should be followed for standard services.

Date of Application: _____

Date of Event: _____

Please complete the following and submit to: _____ *(City Department)*

***City of Brentwood
150 City Park Way
Brentwood, CA 94513
925-516-5400***

1. Proposed Event Name: _____

2. Total Requested Funding and/or fee Amount: \$ _____
(include all fees/departments)

3. Have matching funds been secured for this event? Yes _____ No _____

4. Applicant Information:

Name of Organization/Agency: _____

Contact Name: _____

Mailing Address: _____

Street Address: _____

City: _____ State: _____ Zip: _____

Email Address: _____ Telephone: _____ Fax: _____

Business License #: _____ Nonprofit ID #: _____ (attach copy)

5. Does this event fall under one or more of the City Council Two Year Goals? If yes, please explain:

6. Have you or your organization previously requested and/or received any funding from the City? If yes, please provide any pertinent funding information:



Fee Waiver/Fee Reduction Application

**Finance &
Information Systems**
Effective: February 2017

7. Will promotional materials be created for this event? _____ Yes _____ No

8. Proposed Event Information:

- a. How will the requested funds be used? Describe, in detail, the proposed event. Clearly define any fee schedules that are applicable to this event. Identify if the proposed event is a new service, or extension of an existing one.

- b. Specify the proposed area (e.g., downtown), population or agency that will benefit from this program or event.

- c. What documentation/data/records support the need for this proposed event? Identify your data sources. Additional pages may be included, if needed.

Date of Application: _____

Required Attachments:

Please provide the required copies of the following: *(Please note: Applications without the following documents will not be reviewed for funding)*

Please label attachments A, B, etc.

- A. Names and home addresses of governing board; identify current board officers, etc. Homes addresses are required.
- B. Proof of Non-Profit Status as described in the Policy
- C. Hold harmless agreement - By signing this application you are also signing and agreeing to the Hold Harmless Agreement.



Fee Waiver/Fee Reduction Application

**Finance &
Information Systems**
Effective: February 2017

C. Hold Harmless Agreement

Fiscal Year _____

Applicant, Event Sponsor or Contractor shall hold harmless, defend and indemnify the City of Brentwood (City) and its officers, officials, employees and volunteers from and against any and all liability, loss, damage, expense, costs (including without limitation costs and fees of litigations) of every nature arising out of or in connection with Applicant, Event Sponsor or Contractor's performance of work hereunder or its failure to comply with any of its obligations contained in the agreement except such loss or damage with was caused by the sole negligence or willful misconduct of the City.

Signatures:

Applicant

Date

Name of Organization /Agency

Note: Applicants will be notified within fourteen (14) business days if the request for use of City funds will be granted.

=====

For City of Brentwood Use Only

Approved by: _____ Est. Amt. \$ _____
Director Date

Approved by: _____ Est. Amt. \$ _____
Director Date

Approved by: _____ Est. Amt. \$ _____
Director Date

Approved by: _____ Est. Amt. \$ _____
Director Date

Approved by: _____ Est. Amt. \$ _____
Director Date

Total Fees Waived: \$ _____ (NTE)



Parks and Recreation Office
 (925) 516-5444
 35 Oak Street, Brentwood, CA 94513
 brentwoodca.gov

Permit Number _____

Facility Rental Application

Applicant Information

First Name	Last Name	Date of Birth	Gender: <input type="checkbox"/> M <input type="checkbox"/> F
Address	City	State	Zip Code
Primary Phone Number	Secondary Phone Number	Email Address	
Emergency Contact Name	Emergency Contact Relation	Emergency Contact Phone Number	

Organization Information (if applicable)

Organization Name	Organization Phone Number	Organization Website	
Organization Address	City	State	Zip Code
Organization Email Address	Non-Profit? <input type="checkbox"/> Yes <input type="checkbox"/> No	<input type="checkbox"/> 501(c)(3) Documentation Provided	

Facility Requested (check all that apply)

Community Center <input type="checkbox"/> Community Room A/B (330) <input type="checkbox"/> Conference Room B (25) <input type="checkbox"/> Community Room A (120) <input type="checkbox"/> Multipurpose Room A/B (160) <input type="checkbox"/> Community Room B (150) <input type="checkbox"/> Multipurpose Room A (60) <input type="checkbox"/> Conference Room A/B (80) <input type="checkbox"/> Multipurpose Room B (70) <input type="checkbox"/> Conference Room A (25) <input type="checkbox"/> Kitchen (10)	Senior Center <input type="checkbox"/> Main Hall (208) <input type="checkbox"/> Meeting Room (80) <input type="checkbox"/> Classroom (50) <input type="checkbox"/> Combo Room (130)	Library <input type="checkbox"/> Community Room* (60) *Only available: Wed: 10am-8pm Fri./Sat.: 10am-6pm
---	--	---

Date(s) Requested

Day of the week: Sun Mon Tue Wed Thu Fri Sat Sun Month/Day/Year: _____

Rental Start Time: (enter facility)	Function Start Time: (guests arrive)	Function End Time: (guests leave)	Rental End Time: (exit facility)
--	---	--------------------------------------	-------------------------------------

Note: No access to facility or storage of items before or after rental times.

Type of Event:	Attendance:	Event Details:
<input type="checkbox"/> Adult Birthday <input type="checkbox"/> Performance <input type="checkbox"/> Anniversary <input type="checkbox"/> School Dance <input type="checkbox"/> Banquet <input type="checkbox"/> Shower <input type="checkbox"/> Celebration of Life <input type="checkbox"/> Wedding <input type="checkbox"/> Fundraiser <input type="checkbox"/> Youth Birthday <input type="checkbox"/> Meeting <input type="checkbox"/> Other: _____	Total attendees: _____ (includes caterers, band, DJ, etc.) Attendees under 21: _____ (included in total attendees)	Will food be: <input type="checkbox"/> Served <input type="checkbox"/> Sold If the event is open to the public and food or beverage is being sold or given away, a CCC Environmental Health Temporary Food Permit is required. Will alcohol be: <input type="checkbox"/> Served <input type="checkbox"/> Sold If sold, and ABC Permit is required. Will an admission fee be charged? <input type="checkbox"/> Yes <input type="checkbox"/> No

Liability, Medical Consent, and other Terms of Facility Use

Indemnification. The User hereby voluntarily agrees to indemnify, defend, and hold harmless the City of Brentwood (City) it's officials, officers, employees, agents, and volunteers from any liability for property damage, injuries, or death resulting from or in any way connected with use of City facilities. The Authorized Representatives and User do forever release and hold harmless the City from all claims or rights of action for damage which User may incur as a consequence of the use of the Facility. This waiver and release is applicable except to the extent caused by the City's sole negligence or willful misconduct.

Medical Consent. In emergency situations, User hereby agrees to allow the City staff to consent to any medical treatment that medical personnel deem necessary for any attendees of User's facility rental or event. It is understood that no health or accident insurance is provided by the City. It is further understood that this Contract is binding on my heirs and assigns.

Equipment. I agree to return equipment issued to me in as good condition as when received, except for normal wear and tear.

Photo/Video Release. Authorized Representatives and Participant hereby agree that pictures or videos taken during the Facility rental may be used for future promotional purposes.

Acceptance. My signature below constitutes acceptance of the conditions set forth above.

Signature: _____ Printed Name: _____ Date: _____

1. Reservation of the Facility

Initial: _____

- a. Facility rental applications are accepted no more than 18 months in advance for Brentwood residents, and 12 months in advance for non-residents. Reservations for use of the facilities may be made by contacting the Parks & Recreation Department to schedule a contract appointment. At the contract appointment, a completed application must be submitted, along with a payment of rental deposit and non-refundable application fee.
- b. All rentals require a minimum of 2 hours, and must include any time for setup and cleanup. Refunds will not be given for any unused rental time.
- c. The City accepts the following forms of payment: check/money order; MasterCard, Visa, Discover, and cash. Payments for non-profit organizations or public agencies must be drawn on the organization or agency account.
- d. Reservations must be made at least 30 days prior to the event. Special requests of less than 30 days are considered on a case-by-case basis and an Application Rush Fee will be included.
- e. Renters must be a minimum of 18 years of age. If alcohol is being served, renter must be a minimum of 21 years of age. A photo I.D with the applicant's address and date of birth must be provided at the time of the reservation.
- f. Upon completion of the contract meeting and approval of application, the renter will sign the Facility Permit and be provided a Facility Renter Checklist outlining due dates for fees, various paperwork submittals, and facility walk through and floorplan meeting.
- g. The City reserves the right to book additional events/rentals before and after your event, and in other areas of the facility.
- h. All remaining fees are due 30 days prior to the event. For rentals less than 30 days, all fees are due upon booking of facility. Payment by check will not be accepted less than 30 days prior to the event and payment by credit card will not be accepted less than 14 days prior to the event.
- i. Once the rental permit has been issued, the renter has one opportunity to make any changes or modifications at no additional cost to the rental permit up to 60 days prior to the event date. Changes or modifications made after that one courtesy modification/change to the rental permit will assess an additional fee per request. City reserves the right to assess an additional fee per request, for any reservation changes made less than 60 days prior to the event.
- j. Any changes to the original submitted application must be in writing.
- k. A damage deposit is required for all facility rentals; \$250 for events without alcohol and \$500 for events serving alcohol. The renter will be billed for any additional expenses not covered by the damage deposit. The determination and assessment of additional charges shall be at the sole discretion of the City. The deposit will be returned within 30 days after facility use as long as there is no damage to the facility or any additional expenses incurred.

2. Cancellations

Initial: _____

- a. The City reserves the right to cancel, reschedule, suspend, and/or refuse to grant the use of its facilities to any person or group if such use violates the Brentwood Municipal Code/City Rules and Regulations or in case of emergency.
- b. 100% of rental fees are refunded if cancellations are made 6 months or more prior to your rental date, with the exception of the application fee and the cancellation processing fee.
- c. Cancellations less than 6 months, but more than 4 months prior to your rental date, 15% of your total deposit will be retained in addition to the application fee and the cancellation processing fee.

- d. Cancellations less than 4 months, but more than 1 month prior to your rental date, 25% of your total deposit will be retained in addition to the application fee and the cancellation processing fee.
- e. Cancellations less than 30 days prior to your rental, 40% of the entire rental fee is retained in the addition to the application fee and the cancellation processing fee.
- f. If applicant wishes to cancel their event, a written cancellation letter must be submitted.

3. Use of the Facility

Initial: _____

- a. The facility may be used by residents, non-residents, non-profit organizations and commercial groups, defined as follows:
 - i. Resident: an individual whose primary residence is within the City limits of Brentwood
 - ii. Non-Resident: an individual whose primary residence is outside the City limits of Brentwood
 - iii. Non-Profit: When use of the facility is by a non-profit organization as determined by the Internal Revenue Service and/or State of California with at least 75% of its membership made up of Brentwood residents, and the purpose of the use is to raise funds for community, charitable, or education projects within Brentwood or that benefits Brentwood residents. A copy of the letter granting the organization non-profit status from the Secretary of State's office is required to receive the non-profit rate.
 - iv. Commercial: when use of the facility is for profit or sale with proceeds to benefit an individual or organization.
- b. A minimum of one half hour is required for set-up and takedown of all rentals, although larger events may require more time depending on the size and scope of the event.
- c. After the facility has been used, it must be left in a clean and orderly condition. All equipment moved or borrowed must be returned to its original position and location.
- d. At all times the facility is being used, City staff shall be on duty to ensure the enforcement of these Rules & Regulations. The City reserves the right to close down or cancel any event that is in violation of any city ordinance. The City also reserves the right to close down or cancel the event if public safety, damage to the facility, behavior of the event guests, or affected department supervisors deem the event unsafe for public participation.
- e. The Renter signing the permit is responsible for any loss or damage to the property. The Renter must pay the City an amount equal to the cost of repair and/or replace the lost or damaged item.
- f. The Renter is responsible for the control and supervision of all guests, caterers, musicians, and other contracted service providers, and ensure that all adhere to the City's policies and procedures.
- g. Minors (any person under the age of 18) must be actively supervised at all times.
- h. City staff cannot sign for or receive deliveries. The Renter or a designated representative must be present to supervise and sign for all deliveries and pick-ups associated with their event.
- i. City staff will setup and take down tables and chairs, rented City equipment, and control lighting, audio/visual equipment, and heating and air conditioning.
- j. Equipment brought on site requires prior approval from the City (photo booths, backdrops, BBQs, audio visual equipment, ice sculptures, food truck, etc.) and must be removed immediately after the event. City staff will not store equipment and is not responsible for anything left in the facility. City staff reserves the right to remove any such equipment at the cost of the Renter. Additional charges may be assessed to the Renter for use of the facility beyond the specified rental contracted time. The determination of assessment will be at the sole discretion of the City and will be taken from the Renter's deposit.
- k. The facility maximum capacities are strictly enforced. The maximum capacity for an event includes all adults and children,

including caterers, DJ's, bands, party planners, etc. Violation of the capacity limits will result in immediate termination of the event and forfeiture of some or all of the facility deposit.

- l. No rice, birdseed, confetti, glitter, rose petals, or sand may be thrown inside or outside of the facility.
- m. Smoking of any kind is prohibited in any City facility or within 20 feet of entrance or exit per State of California law (State Code 7596-7598).
- m. All City furniture must stay inside the facility. Any furniture brought in by the Renter (chairs, sofas, tables, light bars, etc.) must have padded or protected feet.
- n. Use of nails, tacks, scotch tape, staples, etc., is strictly prohibited. Only painters tape may be used to attach items to walls. Gaffer tape may be used on the floor.
- o. At no time shall exits or exit signs be covered or obstructed.
- p. The City will not supply ladders, extension cords, scissors, tape or paper for use. Renter must provide supplies, if necessary.
- q. Electrical outlets are limited to 20 amps.
- r. Mylar/foil balloons with helium are prohibited, however air-filled Mylar/foil balloons are permitted.
- s. All decorations must be fire proofed or made of fire retardant materials. Candles are permitted only in holders in which the flame is not exposed (except on cakes). Open flames such as gas burners, candles and butter warmers (with the exception of Sterno-type cups) are not allowed inside the facility.
- t. Fog machines, smoke machines, and hazers are not permitted.
- u. Barbecues, grills, and griddles are permitted only with advance approval and in designated areas.
- v. All decorations must be removed before the premise is vacated.
- w. Parking is available on nearby streets and City parking lots/structure, but is not guaranteed.
- x. Equipment and decorations not listed above requires written approval from City staff.

4. Alcohol

Initial: _____

- a. If alcohol is going to be served or sold, it must be indicated on the rental application and permit.
- b. Alcoholic beverages, if allowed, are the responsibility and liability of the Renter and/or organization renting the facility.
- c. Presence and/or the consumption of any and all alcoholic beverages shall be prohibited except by permit, and only consumed during the event time indicated on the permit.
- d. Alcoholic beverages must be served from a controlled bar by a person over 21 years old and must be served with food. The serving alcohol must end 30 minutes before the conclusion of the event.
- e. To sell alcoholic beverages at your event, a valid alcohol permit from the California Department of Alcoholic Beverage Control (A.B.C.), must be obtained. Events involving the exchange of monetary consideration (example: purchase of meal or meal ticket with any form of alcohol being served as part of the meal) also require a California Department of Alcoholic Beverage Control (A.B.C.) permit. A.B.C. will issue one-day permits to 501(c)3 non-profit groups who wish to sell admission tickets, beer, wine or distilled spirits at a fundraising event. A.B.C. applications are available at the Parks and Recreation office and it is the renter's responsibility to complete and submit the application to A.B.C. (located at Elihn M. Harris State Office Bldg. 1515 Clay Street, Suite 2208, Oakland, CA 94612, (510) 622-4970).
- f. Alcohol permit must be on file in the Parks and Recreation Office 14 days prior to your event. Alcohol permit must be prominently displayed during your event. City staff is required to check your license prior to allowing the sale or distribution of alcohol at the event.

- g. Violation of any of these requirements will result in immediate termination of Renter's event and will result in forfeiture of the damage deposit.

5. Security Guards

Initial: _____

- a. Security guards may be required to be on duty during the event. The Brentwood Police Department will determine if security guards are necessary and the number of guards required at the event. The renter is responsible to pay for these services. Security guards must be present at the times stated on the Brentwood Police Department's Conditions of Approval letter.
- b. Security guard companies must be registered and approved by the Brentwood Police Department and must have a valid City of Brentwood business license. City will provide you a list of approved companies and the renter can select and reserve a company from the list.
- c. The Renter has direction over security guard duties.

6. Insurance

Initial: _____

- a. Renters are responsible for providing insurance. The Renter is accountable financially for any and all accidents or injuries to persons or property resulting from their use of City facilities.
- b. Renters may use their own insurance provided that the policy meets minimum standards (City staff will provide information if choosing this option).
- c. If you are unable to provide this certificate through your homeowners' insurance, you may purchase special event insurance through the City.



Facility Rental Rules & Regulations

City of Brentwood Parks & Recreation

Cleanup Agreement

The Renter agrees to walk the facility, including restrooms, kitchen and rooms reserved with facility staff prior to and after the event to review any current or new damage to the facility that may have occurred during the rental.

The Renter agrees to perform the following:

- a. Pick-up and discard/remove all decorations (e.g. table coverings, wall décor, centerpieces, balloons, etc.)
- b. Pick up all trash, both inside and outside, and place in lined trashcans provided.
- c. Ensure caterers clean kitchen area (i.e. stoves, counters, sinks, remove all items from the refrigerator, etc.)
- d. Report all spills to facility staff immediately for cleanup and allow staff access to area.
- e. Remove all equipment brought in for the event by the rental end time (i.e. by the DJ, decorator, caterer, etc.)
- f. Leave walls, floors, and restrooms undamaged.

By signing below, I agree that at the conclusion of my event I will leave the facility in the same condition as when the event began. I further understand that non-compliance to this Agreement will result in the forfeiture of some, if not all, of my deposit, as well as I may be invoiced for any additional cost to provide for the clean up of my event.

Signature: _____ Printed Name: _____ Date: _____



Facility Rental Rules & Regulations

City of Brentwood Parks & Recreation

Facility Rental Checklist

Initial each item:

_____ I have had the opportunity to read the Rules & Regulations and received a copy.

_____ I will be in attendance throughout the event and I am responsible for the conduct and control of the group.
Children under the age of 18 must be supervised at all times

_____ I have reviewed the rules about decorations.

_____ Facility Walk-Through: I agree to walk through the rented area(s) with City staff before and after the event
(no one will be allowed in the facility before the walk-through.)

_____ The maximum number of people (including guests, DJ/band, caterers, etc.) allowed at my event is _____.
It is my responsibility to control the number of people admitted and not allow more than capacity.

_____ Insurance criteria reviewed. Purchase from City Provide own insurance and endorsement

_____ Security services criteria reviewed.

_____ All contract modifications must be in writing. Additional fees may apply.

_____ Fees must be paid 30 days prior to my rental date or I risk cancellation of my event. (No checks will be accepted for payments made less than 30 days before the rental date. Only cash will be accepted for payments made less than 14 days before the rental date.)

_____ Proof of security guards services, alcohol permit, and/or health permit must be submitted 14 days prior to the rental date (if applicable).

_____ All paperwork, fees, and insurance are due on _____.

Signature: _____ Printed Name: _____ Date: _____

Instructions for Completing Certificate of Insurance for Facility Rentals

Please send this list to your insurance company or broker

Items below MUST be included on your Certificate of Insurance:

- General Liability Insurance Coverage \$1,000,000 CSL
- The name of the insured must match the name and address of the applicant on the Facility Rental Application.
- Event/Facility Rental Date
- Full name of company(s) affording coverage on the Certificate of Insurance.
- Authorized Representative's original signature

Separate endorsement form for General Liability must contain the following:

- The City of Brentwood, its officers, agents, volunteers and employees must be named as an additional insured with respect to liability arising out of activities performed by or on behalf of the Named Insured.
- Coverage under this policy shall be primary insurance as respects the City of Brentwood, its officers, agents, volunteers and employees.
- All rights of subrogation are waived as respects all additional insureds hereunder.

Please mail the Certificate of Insurance, with endorsements to:
City of Brentwood, Parks and Recreation Department, 150 City Park Way, Brentwood, CA 94513

Additional Insured Endorsement MUST read:
City of Brentwood, its officers, agents, volunteers and employees
150 City Park Way
Brentwood, CA 94513



Contra
Costa
County

To: Board of Supervisors
From: Beth Ward, Animal Services Director
Date: March 8, 2022

Subject: Animal Services Monetary Donation Report for October 1, 2021 through December 31, 2021

RECOMMENDATION(S):

ACCEPT the quarterly monetary donation report from the Animal Services Department, which describes the individual source and value of each donation or gift received by the Animal Services Department from October 1, 2021, through December 31, 2021.

FISCAL IMPACT:

This is an informational item only. No fiscal impact. The total value of donations received during this quarter is \$91,777.

BACKGROUND:

In 1998, the Animal Benefit Fund was created by the Animal Services Department to allow the Department to receive donations from individuals, animal welfare organizations and businesses, to support animal health and welfare projects that are not funded by departmental or general County revenue. On April 19, 2016, the Board of Supervisors delegated specific authority to the Animal Services Director, to accept any monetary donation, gift, bequest, or device made to or in favor of the Contra Costa County Animal Services Department, as allowed under Government Code section 25355, and to solicit donations for the benefit of shelter animals. Along with this delegated authority, the Animal Services Director is required to file a report with the Board of Supervisors every quarter that describes the source and value of each gift.

APPROVE

OTHER

RECOMMENDATION OF CNTY ADMINISTRATOR

RECOMMENDATION OF BOARD COMMITTEE

Action of Board On: **03/08/2022** APPROVED AS RECOMMENDED OTHER

Clerks Notes:

VOTE OF SUPERVISORS

AYE: John Gioia, District I Supervisor
Candace Andersen, District II Supervisor
Diane Burgis, District III Supervisor
Karen Mitchoff, District IV Supervisor
Federal D. Glover, District V Supervisor

I hereby certify that this is a true and correct copy of an action taken and entered on the minutes of the Board of Supervisors on the date shown.

ATTESTED: March 8, 2022

Monica Nino, County Administrator and Clerk of the Board of Supervisors

By: Stacey M. Boyd, Deputy

Contact: Delaina Gillaspy, 925-608-8413

cc:

BACKGROUND: (CONT'D)

On December 8, 2020, the Board of Supervisors adopted Resolution No. 2020/326, which authorized the Animal Services Director to implement the following programs within the Animal Benefit Fund beginning FY 2021/22:

1. Medical Assistance Program: This program is for medical assistance and emergency veterinary care for animals that are in the County's jurisdiction and/or have been accepted into the County shelter's care. Funds are used for medical care over and above the mandated medical care for animals in the care of the shelter and that need further assistance to be made available for adoption or released to a transfer agency. Funds may also be used to provide necessary medical care to an animal to help keep the animal out of the shelter.
2. Humane Education Program: This program helps to support humane education services at the County animal shelter and within the community. Humane education support may also be used to help pet owners resolve behavioral problems that might otherwise cause them to give up their pet, to help shelter animals with behavioral issues that might keep them from being easily adopted, and to create humane education programs for school age children.
3. Shelter Intervention Program: Often, families in a crisis turn to surrendering their pet to a shelter due to lack of financial resources. The intervention program helps to provide resources to keep animals in their homes. Examples of intervention tools: spay/neuter, behavior/training assistance, fence repair and grooming. This program may also be used to help domestic violence victims or seniors on limited incomes to keep their pets in their lives when they may otherwise have had to consider relinquishment due to lack of funds for basic daily needs or medical concerns.
4. Spay Neuter and Wellness Program: This program allows spay/neuter, vaccinations, and microchips to be more affordable and accessible in Contra Costa County. Contra Costa Animal Services accomplishes this by establishing partnerships and is developing mobile programs to reach into the areas of the County in greatest need, targeting the species/breeds of animals most likely to be found in the County shelter, and supporting healthy community cats through TNR/RTF (trap-neuter-return / return- to-field) and Working Cat Adoptions.

During the quarter ending December 31, 2021, Animal Services received \$91,777 in donations. The donation report detailing all monetary donations received by the Department from October 1, 2021, through December 31, 2021 is attached. The expenditure of these funds will be included in the FY 21/22 Annual Animal Benefit Fund report. Also attached is the most recent Annual Animal Benefit Fund report for FY 20/21, summarizing the Animal Benefit Fund's financial activities.

CONSEQUENCE OF NEGATIVE ACTION:

Failure to accept the report will delay information the Board has requested.

ATTACHMENTS

FY 20/21 Animal Benefit Fund Report

Animal Services Donation Detail for FY 21/22 Quarter 2



Contra Costa County Board of Supervisors

Subcommittee Report

INTERNAL OPERATIONS COMMITTEE

6.

Meeting Date: 10/11/2021

Subject: 2020/21 Animal Benefit Fund Report

Submitted For: Beth Ward,

Department: Animal Services

Referral No.: IOC 21/8

Referral Name: Animal Benefit Fund PY Review

Presenter: Beth Ward

Contact: Beth Ward (925) 608-8472

Referral History:

In 1988, the Animal Services Department created the Animal Benefit Fund. The purpose of the Animal Benefit Fund (ABF) is to allow the Animal Services Department to receive donations from individuals, animal welfare organizations and businesses, to support animal health and welfare projects that are not funded by departmental or general County revenues.

On April 21, 2015, during fiscal year 2015/16 budget hearings, the Board of Supervisors formally referred to the Internal Operations Committee (IOC) a review of the Animal Benefit Fund. On April 19, 2016, The Board of Supervisors approved, at the recommendation of the IOC, expansion of the Animal Benefit Fund approved uses (see attached Archived Board Order dated 4/19/16) and directed the Animal Services Director to report annually to the IOC about the impact of the Animal Benefit Fund on the community and families, creating a new standing referral. The IOC has previously received four such reports for FYs 2016/17, 2017/18, 2018/19, and 2019/20.

Since the creation of the Animal Benefit Fund more than 30 years ago, monetary contributions and donations for services and supplies for animal welfare have provided additional support for unfunded needs of the animals impounded at the shelter and in our community. These donations have come in the form of grants or “soft ask” gifts over the counter or from the Animal Services Department website.

On December 8, 2020, the Board of Supervisors adopted Resolution No. 2020/326, which authorized the Department Director to implement the following programs within the Animal Benefit Fund beginning FY 2021/22:

1. Medical Assistance Program: This program is for medical assistance and emergency veterinary care for animals that are in the County's jurisdiction and/or have been accepted into the County shelter's care. Funds will be used for medical care over and above the mandated medical care for animals in the care of the shelter and who need further assistance to be made available for adoption or released to a transfer agency. Funds may also be used to provide necessary medical care to an animal to help keep the animal out of the shelter.

2. Humane Education Program: This program helps to support humane education services in our county either by bringing people into County shelter or taking County education programs “on the road” into the

community. Humane Education support may also be used to help pet owners resolve behavioral problems that might otherwise cause them to give up their pet, to help shelter animals with behavioral issues that might keep them from being easily adopted, and to create humane education programs for school age children.

3. Shelter Intervention Program: Often, families in a crisis turn to surrendering their pet to a shelter due to lack of financial resources. The intervention program helps to provide resources to keep animals in their homes. Examples of intervention tools: spay/neuter, behavior/training assistance, fence repair and grooming. This program may also be used to help domestic violence victims or seniors on limited incomes to keep their pets in their lives when they may otherwise have had to consider relinquishment due to lack of funds for basic daily needs or medical concerns.

4. Spay Neuter and Wellness Program: This program would make spay/neuter, vaccinations, and microchips more affordable and accessible in Contra Costa County. Contra Costa Animal Services will accomplish this by establishing partnerships and developing mobile programs to reach into the areas of our county in greatest need, targeting the species/breeds of animals most likely to be found in our shelter, and supporting healthy community cats through TNR/RTF (trap-neuter-return / return- to-field) and Working Cat Adoptions.

Referral Update:

ANNUAL REPORT

For FY 2020/21, the Department allocated \$100,000 for Animal Benefit Fund (ABF) Programs. The ABF funds are not intended to replace General Funds, rather they are to supplement and enhance our care for animals and support of the public. The table below details the allocation, adjustment, and balances for each ABF program for FY 2020/21:

Animal Benefit Fund (ABF) FY 2020/21

ABF Fund Balance

Fund	Appropriation	Amount
133200	Beginning balance	\$216,685
133200	19/20 Expenditures	98,426
133200	19/20 Revenue	<u>232,121</u>
133200	Ending Balance	\$350,381

Expenses

Org	ABF Program	Appropriation	Year-to-Date Expenditures	Remaining Balance
3350	Medical Assistance Program	1,500	1,208	292
3351	Humane Education Program	0	0	0
3352	Shelter Intervention Program	15,000	13,894	1,106
3354	Spay and Neuter Program	<u>83,500</u>	<u>83,324</u>	<u>176</u>
		\$100,000	\$98,426	\$1,574

Revenue

Org	Type of Donations	Estimated Revenue	Collected	Unrealized Revenue
9181	Pooled Earnings	0	1,246	(1,246)

9965	Donations	150,000	139,665	10,335
9965	Spay/Neuter Fee Donations	0	91,210	(91,210)
9966	Grants	<u>0</u>	<u>0</u>	<u>0</u>
	Totals:	\$150,000	\$232,121	\$(82,121)

The key factors that affected the FY 2020/21 ABF budget were:

1. Underutilization of community partners spay/neuter contracts, due to impacts of COVID-19 on availability of medical supplies and the State of California’s Veterinary Medical Board (CVMB) recommendations identifying spay/neuter (S/N) and specialty care services as non-essential veterinary medical services.

2. The Department did not meet its donation revenue goal estimated at \$150,000 but collected close to \$140,000 in actual donations for FY 2020/21. We believe the ABF donations decreased because of the financial hardships our community faced during COVID-19. We do expect to receive a higher donation pool in FY 2021/22.

3. In January 2020, the Department implemented the \$10 donation for each “unaltered” animal license sold. These donations are allocated specifically for the Spay and Neuter Program. The Department received \$91,210 towards these services. This program has allowed us to exceed our prior donation totals by \$100,000.

Recommendation(s)/Next Step(s):

ACCEPT the 2020/21 Animal Benefit Fund Department Report.

Fiscal Impact (if any):

No fiscal impact. This is an informational report with recommendations that will not affect the amount of funds allocated for animal services and programs, but rather how donated funds can be expended.

Attachments-Y

Animal Benefit Fund Presentation

ARCHIVED DOCUMENT: April 2016 Board Order Expanding Animal Benefit Fund Program

Contra Costa Animal Services

Detail Donation Report for October 1, 2021 - December 31, 2021

Program	Type of Donations	Date Posted	Amount
General ABF	General Donation	12/30/2021	\$80.00
General ABF	General Donation	12/30/2021	\$30.00
General ABF	General Donation	12/30/2021	\$80.00
General ABF	General Donation	12/30/2021	\$500.00
General ABF	General Donation	12/30/2021	\$47.78
General ABF	General Donation	12/30/2021	\$121.00
General ABF	Website Donations	12/30/2021	\$250.00
General ABF	Website Donations	12/30/2021	\$150.00
General ABF	General Donation	12/30/2021	\$79.00
General ABF	General Donation	12/30/2021	\$86.00
General ABF	Website Donations	12/28/2021	\$5.00
General ABF	General Donation	12/28/2021	\$20.00
General ABF	General Donation	12/28/2021	\$36.00
General ABF	Website Donations	12/28/2021	\$600.00
General ABF	General Donation	12/27/2021	\$25.00
General ABF	Website Donations	12/27/2021	\$10.00
General ABF	General Donation	12/27/2021	\$35.00
General ABF	General Donation	12/27/2021	\$265.00
General ABF	General Donation	12/27/2021	\$70.00
General ABF	General Donation	12/27/2021	\$2,750.00
General ABF	General Donation	12/22/2021	\$63.00
General ABF	Website Donations	12/22/2021	\$200.00
General ABF	General Donation	12/22/2021	\$190.00
General ABF	General Donation	12/21/2021	\$5.50
General ABF	General Donation	12/21/2021	\$57.00
General ABF	General Donation	12/21/2021	\$50.00
General ABF	Website Donations	12/21/2021	\$25.00
General ABF	Website Donations	12/21/2021	\$200.00
General ABF	General Donation	12/21/2021	\$21.00
General ABF	General Donation	12/21/2021	\$100.00
General ABF	General Donation	12/21/2021	\$40.00
General ABF	General Donation	12/21/2021	\$82.00
General ABF	Website Donations	12/21/2021	\$200.00
General ABF	General Donation	12/21/2021	\$179.00
General ABF	General Donation	12/21/2021	\$179.00
General ABF	General Donation	12/21/2021	\$100.00
General ABF	General Donation	12/21/2021	\$285.94
General ABF	General Donation	12/21/2021	\$20.76
General ABF	General Donation	12/16/2021	\$84.00
General ABF	Website Donations	12/16/2021	\$705.00

Program	Type of Donations	Date Posted	Amount
General ABF	General Donation	12/16/2021	\$35.00
General ABF	General Donation	12/15/2021	\$26.00
General ABF	General Donation	12/15/2021	\$343.00
General ABF	Website Donations	12/14/2021	\$70.00
General ABF	General Donation	12/14/2021	\$261.00
General ABF	General Donation	12/14/2021	\$112.00
General ABF	General Donation	12/13/2021	\$268.00
General ABF	General Donation	12/13/2021	\$212.00
General ABF	General Donation	12/13/2021	\$20.00
General ABF	Website Donations	12/13/2021	\$50.00
General ABF	General Donation	12/10/2021	\$180.00
General ABF	General Donation	12/10/2021	\$85.00
General ABF	General Donation	12/10/2021	\$30.00
General ABF	Website Donations	12/8/2021	\$275.00
General ABF	General Donation	12/8/2021	\$75.00
General ABF	General Donation	12/8/2021	\$130.00
General ABF	Website Donations	12/8/2021	\$100.00
General ABF	Website Donations	12/8/2021	\$20.00
General ABF	General Donation	12/8/2021	\$200.00
General ABF	General Donation	12/8/2021	\$391.00
General ABF	General Donation	12/8/2021	\$45.00
General ABF	General Donation	12/8/2021	\$62.00
General ABF	General Donation	12/8/2021	\$50.00
General ABF	General Donation	12/8/2021	\$190.00
General ABF	General Donation	12/8/2021	\$61.00
General ABF	General Donation	12/8/2021	\$68.00
General ABF	Website Donations	12/8/2021	\$1,145.00
General ABF	General Donation	12/8/2021	\$70.00
General ABF	General Donation	12/8/2021	\$2,250.00
General ABF	General Donation	12/3/2021	\$2,075.00
General ABF	Website Donations	12/1/2021	\$70.00
General ABF	General Donation	12/1/2021	\$25.00
General ABF	General Donation	12/1/2021	\$81.00
General ABF	General Donation	12/1/2021	\$100.00
General ABF	General Donation	12/1/2021	\$200.00
General ABF	General Donation	12/1/2021	\$42.00
General ABF	General Donation	12/1/2021	\$82.00
General ABF	General Donation	12/1/2021	\$1,045.50
General ABF	General Donation	12/1/2021	\$132.00
General ABF	General Donation	12/1/2021	\$127.00
General ABF	Website Donations	12/1/2021	\$100.00
General ABF	General Donation	11/30/2021	\$265.00
General ABF	General Donation	11/30/2021	\$83.00

Program	Type of Donations	Date Posted	Amount
General ABF	General Donation	11/30/2021	\$281.00
General ABF	General Donation	11/30/2021	\$190.00
General ABF	General Donation	11/30/2021	\$60.00
General ABF	General Donation	11/30/2021	\$30.00
General ABF	Website Donations	11/30/2021	\$200.00
General ABF	General Donation	11/30/2021	\$198.00
General ABF	General Donation	11/30/2021	\$411.14
General ABF	General Donation	11/30/2021	\$75.00
General ABF	Website Donations	11/30/2021	\$350.00
General ABF	General Donation	11/24/2021	\$185.00
General ABF	General Donation	11/24/2021	\$1,577.00
General ABF	General Donation	11/24/2021	\$156.00
General ABF	General Donation	11/24/2021	\$259.00
General ABF	General Donation	11/24/2021	\$20.00
General ABF	General Donation	11/24/2021	\$310.00
General ABF	General Donation	11/24/2021	\$238.00
General ABF	Website Donations	11/24/2021	\$1,000.00
General ABF	General Donation	11/24/2021	\$10.00
General ABF	General Donation	11/24/2021	\$261.00
General ABF	General Donation	11/24/2021	\$47.00
General ABF	General Donation	11/24/2021	\$163.00
General ABF	General Donation	11/24/2021	\$58.00
General ABF	General Donation	11/24/2021	\$305.00
General ABF	General Donation	11/24/2021	\$75.00
General ABF	General Donation	11/24/2021	\$281.00
General ABF	General Donation	11/24/2021	\$218.68
General ABF	General Donation	11/24/2021	\$331.00
General ABF	Website Donations	11/24/2021	\$50.00
General ABF	Website Donations	11/24/2021	\$20.00
General ABF	General Donation	11/24/2021	\$75.00
General ABF	General Donation	11/24/2021	\$60.00
General ABF	General Donation	11/24/2021	\$270.00
General ABF	General Donation	11/17/2021	\$3,075.50
General ABF	General Donation	11/17/2021	\$514.00
General ABF	General Donation	11/17/2021	\$5,159.00
General ABF	General Donation	11/16/2021	\$1,338.00
General ABF	General Donation	11/16/2021	\$338.68
General ABF	General Donation	11/16/2021	\$230.10
General ABF	General Donation	11/12/2021	\$60.00
General ABF	General Donation	11/12/2021	\$110.00
General ABF	General Donation	11/12/2021	\$225.00
General ABF	General Donation	11/12/2021	\$60.00
General ABF	General Donation	11/12/2021	\$40.00

Program	Type of Donations	Date Posted	Amount
General ABF	General Donation	11/12/2021	\$60.00
General ABF	Website Donations	11/12/2021	\$100.00
General ABF	General Donation	11/12/2021	\$268.00
General ABF	Website Donations	11/12/2021	\$450.00
General ABF	General Donation	11/12/2021	\$115.00
General ABF	General Donation	11/12/2021	\$62.00
General ABF	General Donation	11/12/2021	\$500.50
General ABF	General Donation	11/10/2021	\$40.00
General ABF	General Donation	11/8/2021	\$2,500.00
General ABF	General Donation	11/8/2021	\$100.00
General ABF	General Donation	11/8/2021	\$169.00
General ABF	General Donation	11/8/2021	\$1,020.76
General ABF	Website Donations	11/8/2021	\$1,000.00
General ABF	General Donation	11/8/2021	\$156.00
General ABF	General Donation	11/8/2021	\$7.50
General ABF	General Donation	11/8/2021	\$25.00
General ABF	General Donation	11/8/2021	\$70.00
General ABF	General Donation	11/8/2021	\$61.00
General ABF	General Donation	11/8/2021	\$30.00
General ABF	General Donation	11/8/2021	\$25.00
General ABF	General Donation	11/8/2021	\$96.00
General ABF	General Donation	11/8/2021	\$30.00
General ABF	General Donation	11/8/2021	\$20.00
General ABF	General Donation	11/8/2021	\$25.00
General ABF	General Donation	11/8/2021	(\$25,000.00)
General ABF	General Donation	11/3/2021	\$86.00
General ABF	General Donation	11/3/2021	\$77.00
General ABF	General Donation	11/3/2021	\$10.00
General ABF	General Donation	10/29/2021	\$25.00
General ABF	General Donation	10/29/2021	\$66.00
General ABF	General Donation	10/29/2021	\$397.00
General ABF	General Donation	10/27/2021	\$100.00
General ABF	General Donation	10/27/2021	\$39.00
General ABF	Website Donations	10/27/2021	\$100.00
General ABF	General Donation	10/27/2021	\$55.00
General ABF	General Donation	10/27/2021	\$125.00
General ABF	General Donation	10/27/2021	\$10.00
General ABF	General Donation	10/27/2021	\$10.00
General ABF	General Donation	10/27/2021	\$150.00
General ABF	Website Donations	10/27/2021	\$100.00
General ABF	General Donation	10/27/2021	\$100.00
General ABF	General Donation	10/27/2021	\$139.00
General ABF	General Donation	10/27/2021	\$30.00

Program	Type of Donations	Date Posted	Amount
General ABF	General Donation	10/25/2021	\$100.00
General ABF	General Donation	10/25/2021	\$6.00
General ABF	General Donation	10/25/2021	\$85.00
General ABF	Website Donations	10/25/2021	\$100.00
General ABF	General Donation	10/25/2021	\$12.00
General ABF	General Donation	10/25/2021	\$12.00
General ABF	General Donation	10/21/2021	\$67.00
General ABF	General Donation	10/21/2021	\$119.00
General ABF	General Donation	10/21/2021	\$20.00
General ABF	General Donation	10/21/2021	\$10.00
General ABF	General Donation	10/21/2021	\$179.00
General ABF	General Donation	10/21/2021	\$70.00
General ABF	General Donation	10/21/2021	\$123.00
General ABF	General Donation	10/21/2021	\$61.00
General ABF	Website Donations	10/21/2021	\$10.00
General ABF	General Donation	10/15/2021	\$85.00
General ABF	General Donation	10/15/2021	\$21.00
General ABF	General Donation	10/15/2021	\$75.00
General ABF	General Donation	10/15/2021	\$366.00
General ABF	General Donation	10/15/2021	\$50.00
General ABF	General Donation	10/15/2021	\$200.00
General ABF	General Donation	10/15/2021	\$103.00
General ABF	General Donation	10/15/2021	\$25,000.00
General ABF	General Donation	10/13/2021	\$20.00
General ABF	General Donation	10/13/2021	\$100.00
General ABF	General Donation	10/13/2021	\$26.00
General ABF	General Donation	10/13/2021	\$50.00
General ABF	General Donation	10/11/2021	\$46.00
General ABF	General Donation	10/11/2021	\$80.00
General ABF	General Donation	10/8/2021	\$170.00
General ABF	General Donation	10/8/2021	\$240.76
General ABF	General Donation	10/8/2021	\$85.50
General ABF	General Donation	10/8/2021	\$50.00
General ABF	General Donation	10/8/2021	\$40.00
General ABF	General Donation	10/8/2021	\$186.00
General ABF	General Donation	10/8/2021	\$85.00
General ABF	General Donation	10/8/2021	\$115.00
General ABF	General Donation	10/8/2021	\$25.00
General ABF	General Donation	10/8/2021	\$20.00
General ABF	General Donation	10/6/2021	\$10.00
General ABF	General Donation	10/6/2021	\$1,470.00
General ABF	General Donation	10/6/2021	\$20.00
General ABF	General Donation	10/1/2021	\$100.00

Program	Type of Donations	Date Posted	Amount
General ABF	General Donation	10/1/2021	\$20.00
General ABF	General Donation	10/1/2021	\$481.00
General ABF	General Donation	10/1/2021	\$40.00
General ABF	GRANT	11/8/2021	\$25,000.00
S/N Program	Licensing Donations	10/25/2021	\$14,680.00
Total			\$91,777.60

Summary by Donation Type

Type	Total:
General Donatior	\$44,442.60
GRANT	\$25,000.00
Licensing Donatic	\$14,680.00
Website Donatioi	\$7,655.00
Grand Total	\$91,777.60



Contra
Costa
County

To: Board of Supervisors
From: Monica Nino, County Administrator
Date: March 8, 2022

Subject: Successor Agency to the Hercules Redevelopment Agency - Subordination Agreement

RECOMMENDATION(S):

APPROVE and AUTHORIZE the County Administrator, or designee, to execute an Acknowledgement of Subordination with the Successor Agency to the Hercules Redevelopment Agency, in connection with an upcoming issuance of tax allocation refunding bonds by the Successor Agency.

FISCAL IMPACT:

Based on the current rate environment in the municipal securities market, debt service savings related to the issuance of the refunding bonds would result in an anticipated net present value savings of \$3.5 million to agencies governed by the Board of Supervisors. More detail on each agency is discussed in the Background section of this Board Order.

The Agency currently owes the County in excess of \$9 million in pass-through payment arrearages as part of the redevelopment dissolution process. Annual debt service savings associated with the proposed bond issuance will allow the Agency to more quickly reimburse the County for the pass-through payments due and payable.

APPROVE

OTHER

RECOMMENDATION OF CNTY ADMINISTRATOR

RECOMMENDATION OF BOARD COMMITTEE

Action of Board On: **03/08/2022** APPROVED AS RECOMMENDED OTHER

Clerks Notes:

VOTE OF SUPERVISORS

AYE: John Gioia, District I Supervisor
Candace Andersen, District II Supervisor
Diane Burgis, District III Supervisor
Karen Mitchoff, District IV Supervisor
Federal D. Glover, District V Supervisor

I hereby certify that this is a true and correct copy of an action taken and entered on the minutes of the Board of Supervisors on the date shown.

ATTESTED: March 8, 2022

, County Administrator and Clerk of the Board of Supervisors

By: Stacey M. Boyd, Deputy

Contact: Timothy Ewell, (925) 655-2043

cc:

BACKGROUND:

History of the Hercules Redevelopment Agency

The Hercules Redevelopment Agency (the "Former Agency") was dissolved pursuant to Part 1.85 of Division 24 of the California Health and Safety Code (the "Dissolution Act") and was superceded by the Successor Agency to the Hercules Redevelopment Agency (the "Agency"). The Former Agency and the County entered into an agreement, dated as of November 23, 1983, as amended on June 5, 2001 (the "Pass-Through Agreement"), providing, among other matters, for the allocation and payment of certain tax increment revenues from the Former Agency's Dynamite Redevelopment Project Area to the County.

On June 1, 2005, the Former Agency and the County entered into a Subordination Agreement (the "Original Subordination Agreement") pursuant to which the County agreed to subordinate its rights to receive tax increment revenue payments under the Pass-Through Agreement, in order for the Former Agency to be able to pledge such tax increment revenue to long-term bonded indebtedness. This has been and continues to be a standard practice in the issuance of tax allocation bond financing. The Former Agency issued its Hercules Merged Area Tax Allocation Bonds, Series 2005 in the amount of \$56,260,000 (the "2005 Bonds") and pursuant to the Original Subordination Agreement, the County's payments under the Pass-Through Agreement were subordinated to payments due under the 2005 Bonds. This means that if the available revenue was not sufficient to pay both the debt service and the pass-through payments, then the debt service payments would be made first prior to paying pass-through payments to taxing entities. The Former Agency subsequently issued its Hercules Merged Area Tax Allocation Bonds, Series 2007 (the "2007 Bonds" and, together with the 2005 Bonds, the "Bonds") on parity with the 2005 Bonds; however no amendment of the Original Subordination Agreement was entered into in connection with the 2007 Bonds

Ambac Bond Insurance Litigation

The 2007 Bonds and the 2005 Bonds were each insured by a municipal bond insurance policy (the "Policies") issued by Ambac Assurance Corporation ("Ambac"). Due to significant and persistent declines in assessed value within the Hercules Merged Project Area, the Bonds were placed into default, and Ambac subsequently made payments pursuant to the Policies to bondholders as a result of the default. Pursuant to the Indenture, dated as of August 1, 2005, by and between the Former Agency and The Bank of New York Trust Company N.A., as supplemented and amended (the "Indenture"), Ambac had the right to declare all of the principal and interest due on the Bonds to be accelerated. The Agency and Ambac were parties to litigation in the Contra Costa County Superior Court in connection with the default on the Bonds (Case No. CIVMSN 12-0182) and agreed to settle such litigation pursuant to an Amended Settlement Agreement, which required as one of the conditions precedent to its effectiveness, among other conditions, that the Agency enter into an Amended and Restated Subordination Agreement. The County and the Agency entered into the Amended and Restated Subordination Agreement in 2014.

Potential Refunding of Tax Allocation Bonds

Since 2014, the Agency has worked diligently to improve its financial condition. In addition, municipal bond rates remain at historical lows making it an excellent time to refund existing bonds for cost savings. Today's action would authorize the subordination of pass-through payments to the anticipated 2022 tax allocation refunding bonds planned by the District. As previously stated, this is a common practice to provide investors assurance that debt service will be paid prior to other obligations.

It is important to note that with the dissolution of redevelopment agencies in California, any debt service savings from the Agency would be returned to taxing entities through the Redevelopment Property Tax Trust Fund (RPTTF) rather than being kept by the Agency, so it is in the interest of agencies governed by the Board of Supervisors to allow for the subordination of pass-through agreements. This allows for the issuance of the bonds resulting in a reduced debt service payment in future years, which yields more net revenue to pay those pass-through payments.

Estimates of net present value (NPV) savings over a period of 20 years to agencies governed by the Board of Supervisors through future distributions of residual RPTTF allocations due to the anticipated debt service savings, include:

<u>Taxing Entity</u>	<u>Anticipated NPV Savings</u>
County General	\$2,848,693
West CC Healthcare	306,286
County Library	298,956
CC Flood Control	35,078
Flood Control Z-8	2,699
Flood Control Z-8A	4,366
Co Water Agency	<u>7,147</u>
Total	\$3,503,225

CONSEQUENCE OF NEGATIVE ACTION:

The Acknowledgement of Subordination will not be executed and it is unclear whether the Agency would be able to move forward with issuing the refunding bonds. In the case that the Agency does move forward, it would result in less than anticipated debt service savings because investors will require an additional rate premium due to a subordination of pass-through payments not being in place.

CHILDREN'S IMPACT STATEMENT:

No impact.

ATTACHMENTS

Acknowledgement of Subordination

ACKNOWLEDGEMENT

In response to the request by the Successor Agency to the Hercules Redevelopment Agency (the “Successor Agency”) set forth in a letter dated January 13, 2022 from Edwin Gato, the Director of Finance of the City of Hercules (the “Subordination Request”), the County of Contra Costa hereby confirms its approval of the subordination of the Successor Agency’s Statutory Pass-through Payments and Negotiated Pass-through Payments to the County of Contra Costa with respect to the Project Area to the Successor Agency’s payment obligations for the Refunding Bonds. The County further confirms that all amounts outstanding, as Statutory Pass-through Payments and Negotiated Pass-through Payments are included within this subordination approval.

All capitalized terms used but not defined in this Acknowledgement have the meaning ascribed to them in the Subordination Request.

IN WITNESS WHEREOF, the undersigned has caused this Acknowledgement to be signed by its authorized representative on this 8th day of March, 2022.

COUNTY OF CONTRA COSTA

By: _____

Name: _____

Title: _____



Contra
Costa
County

To: Board of Supervisors
From: Monica Nino, County Administrator
Date: March 8, 2022

Subject: 2022 APPOINTMENT OF STANDBY OFFICERS TO MEMBERS OF THE BOARD OF SUPERVISORS

RECOMMENDATION(S):

1. UPDATE the official list of persons to serve, in priority order, as standby officers for the respective members of the Board of Supervisors, pursuant to County Ordinance Code section 42-4.004:

	<u>District I</u>	<u>District II</u>	<u>District III</u>	<u>District IV</u>	<u>District V</u>
1	Sonia Bustamante	Phil Andersen	Mark Goodwin	Ron Mullin	Janis Glover
2	Robert Rogers	Gayle Israel	Teresa Gerringner	Guy Bjerke	David Fraser
3	Paul Fadelli	Catharine Baker	Mary Piepho	Tamara Steiner	Vincent Manuel

2. DIRECT that the above appointments supersede all previous appointments.

APPROVE

OTHER

RECOMMENDATION OF CNTY ADMINISTRATOR

RECOMMENDATION OF BOARD COMMITTEE

Action of Board On: **03/08/2022** APPROVED AS RECOMMENDED OTHER

Clerks Notes:

VOTE OF SUPERVISORS

AYE: John Gioia, District I Supervisor
Candace Andersen, District II Supervisor
Diane Burgis, District III Supervisor
Karen Mitchoff, District IV Supervisor
Federal D. Glover, District V Supervisor

I hereby certify that this is a true and correct copy of an action taken and entered on the minutes of the Board of Supervisors on the date shown.

ATTESTED: March 8, 2022

Monica Nino, County Administrator and Clerk of the Board of Supervisors

By: Stacey M. Boyd, Deputy

Contact: Jami Morrirt 925-655-2005

cc:

RECOMMENDATION(S): (CONT'D)

3. REQUEST that the Emergency Services Division of the Sheriff's Office meet with any Standby Officer that requests it, and provide an overview of the County Emergency System, to include written procedures and contact information, and address any questions raised by the Standby Officers.

4. CONFIRM that the temporary County seat shall continue to be a.) Diablo Valley College, Pleasant Hill, California, as the alternative county seat for Contra Costa County if war or enemy-caused disaster, or the imminence thereof, prevents access to the permanent Contra Costa County seat in Martinez; and b) The Alameda County Emergency Operations Center, Dublin, California as the alternative county seat for Contra Costa County if war or enemy-caused disaster, or the imminence thereof, prevents access to facilities in Contra Costa County, as provided in Resolution No. 2018/70.

FISCAL IMPACT:

None

BACKGROUND:

Pursuant to the California Emergency Services Act, Article 15, Preservation of Local Government, the governing body of a political subdivision of the State is required to appoint three Standby Officers for each member of the governing body. Accordingly, Section 42-4.004 of the County Ordinance Code requires the Board to make such appointments.

A Standby Officer appointed by the Board is to serve in place of a regular Board member when the regular Board member is unavailable during a state of war emergency, a state of emergency, or a local emergency. (Unavailable means that the regular Board member has been killed, is missing, or is seriously injured as to be unable to attend meetings and otherwise perform his/her duties.) Appointment of the specified Standby Officers will assure a line of succession so that in the event of the unavailability of one or more regular Board members during a state of war emergency, a state of emergency, or a local emergency, the business of the Board of Supervisors (BOS) may continue to be conducted with a full complement of Board members. A Standby Officer shall serve until the regular officer becomes available or until the election or appointment of a new regular officer.

As required by County Ordinance Code, the status of these Standby Officer appointments will be reviewed annually to determine if any changes in appointees is necessary. Government Code section 8641 sets out the duties of Standby Officers for the Board of Supervisors:

- To be informed of the Supervisor's duties.
- To be informed of the business and affairs of the County.
- To immediately report for duty in the event of a state of war emergency, state of emergency, or state of local emergency.
- To fill the Supervisors post when the Supervisor is unavailable (dead, missing, or seriously injured) due to a state of war emergency, state of emergency, or state of local emergency.

The County must provide the Standby Officers with copies of California Emergency Services Act, Article 15: Preservation of Local Government (Gov. Code, §§ 8635-8644.) (See attachment.) The County can also host meetings to keep the Standby Officers informed about County business and can require their attendance at these meetings. (Gov. Code, § 8641 (b).) Standby Officers must take the same oath of office as the Supervisor and serve at the pleasure of the BOS. (Gov. Code, § 8640.) Pursuant to County Ordinance Code section 42-4.010, during the second regular Board meeting in March, the Board appoints standby officers.

CONSEQUENCE OF NEGATIVE ACTION:

Without the appointment of the specified standby officers, there will be no line of succession in the event of the unavailability of one or more regular Board members during a state of war emergency, a state of emergency, or a local emergency. Therefore, the business of the Board of Supervisors may not be conducted with a full complement of Board members.

ATTACHMENTS

Article 15. Preservation of Local Government

[Up^](#)[Add To My Favorites](#)**GOVERNMENT CODE - GOV****TITLE 2. GOVERNMENT OF THE STATE OF CALIFORNIA [8000 - 22980]** (Title 2 enacted by Stats. 1943, Ch. 134.)**DIVISION 1. GENERAL [8000 - 8899.24]** (Division 1 enacted by Stats. 1943, Ch. 134.)**CHAPTER 7. California Emergency Services Act [8550 - 8668]** (Chapter 7 added by Stats. 1970, Ch. 1454.)**ARTICLE 15. Preservation of Local Government [8635 - 8644]** (Article 15 added by Stats. 1970, Ch. 1454.)

8635. The Legislature recognizes that if this state or nation were attacked by an enemy of the United States, many areas in California might be subjected to the effects of an enemy attack and some or all of these areas could be severely damaged. During such attacks and in the reconstruction period following such attacks, law and order must be preserved and so far as possible government services must be continued or restored. This can best be done by civil government. To help to preserve law and order and to continue or restore local services, it is essential that the local units of government continue to function.

In enacting this article the Legislature finds and declares that the preservation of local government in the event of enemy attack or in the event of a state of emergency or a local emergency is a matter of statewide concern. The interdependence of political subdivisions requires that, for their mutual preservation and for the protection of all the citizens of the State of California, all political subdivisions have the power to take the minimum precautions set forth in this article. The purpose of this article is to furnish a means by which the continued functioning of political subdivisions will be assured. Should any part of this article be in conflict with or inconsistent with any other part of this chapter, the provisions of this article shall control.

Nothing in this article shall prevent a city or county existing under a charter from amending said charter to provide for the preservation and continuation of its government in the event of a state of war emergency.

(Amended by Stats. 1974, Ch. 595.)

8636. As used in this article, "unavailable" means that an officer is either killed, missing, or so seriously injured as to be unable to attend meetings and otherwise perform his duties. Any question as to whether a particular officer is unavailable shall be settled by the governing body of the political subdivision or any remaining available members of said body (including standby officers who are serving on such governing body).

(Added by Stats. 1970, Ch. 1454.)

8637. Each political subdivision may provide for the succession of officers who head departments having duties in the maintenance of law and order or in the furnishing of public services relating to health and safety.

(Added by Stats. 1970, Ch. 1454.)

8638. To provide for the continuance of the legislative and executive departments of the political subdivision during a state of war emergency or a state of emergency or a local emergency the governing body thereof shall have the power to appoint the following standby officers:

- (a) Three for each member of the governing body.
- (b) Three for the chief executive, if he is not a member of the governing body.

In case a standby office becomes vacant because of removal, death, resignation, or other cause, the governing body shall have the power to appoint another person to fill said office.

Standby officers shall be designated Nos. 1, 2, and 3 as the case may be.

(Amended by Stats. 1974, Ch. 595.)

8639. The qualifications of each standby officer should be carefully investigated, and the governing body may request the Director of Emergency Services to aid in the investigation of any prospective appointee. No

examination or investigation shall be made without the consent of the prospective appointee.

Consideration shall be given to places of residence and work, so that for each office for which standby officers are appointed there shall be the greatest probability of survivorship. Standby officers may be residents or officers of a political subdivision other than that to which they are appointed as standby officers.

(Amended by Stats. 2013, Ch. 352, Sec. 176. Effective September 26, 2013. Operative July 1, 2013, by Sec. 543 of Ch. 352.)

8640. Each standby officer shall take the oath of office required for the officer occupying the office for which he stands by. Persons appointed as standby officers shall serve in their posts as standby officers at the pleasure of the governing body appointing them and may be removed and replaced at any time with or without cause.

(Added by Stats. 1970, Ch. 1454.)

8641. Each standby officer shall have the following duties:

(a) To inform himself or herself of the duties of the office for which the officer stands by. Officers and employees of the political subdivision shall assist the standby officer and each political subdivision shall provide each standby officer with a copy of this article.

(b) To keep informed of the business and affairs of the political subdivision to the extent necessary to enable the standby officer to fill his or her post competently. For this purpose the political subdivision may arrange information meetings and require attendance.

(c) To immediately report himself or herself ready for duty in the event of a state of war emergency or in the event of a state of emergency or a local emergency at the place and in the method previously designated by the political subdivision.

(d) To fill the post for which he or she has been appointed when the regular officer is unavailable during a state of war emergency, a state of emergency or a local emergency. Standby officers Nos. 2 and 3 shall substitute in succession for standby officer No. 1 in the same way that standby officer No. 1 is substituted in place of the regular officer. The standby officer shall serve until the regular officer becomes available or until the election or appointment of a new regular officer.

(Amended by Stats. 1992, Ch. 1020, Sec. 1.7. Effective January 1, 1993.)

8642. Whenever a state of war emergency a state of emergency or a local emergency exists the governing body of the political subdivision shall meet as soon as possible. The place of meeting need not be within the political subdivision. The meeting may be called by the chief executive of the political subdivision or by a majority of the members of the governing body. Should there be only one member of the governing body, he may call and hold said meeting and perform acts necessary to reconstitute the governing body.

(Amended by Stats. 1974, Ch. 595.)

8643. During a state of war emergency a state of emergency or a local emergency the governing body shall:

(a) Ascertain the damage to the political subdivision and its personnel and property. For this purpose it shall have the power to issue subpoenas to compel the attendance of witnesses and the production of records.

(b) Proceed to reconstitute itself by filling vacancies until there are sufficient officers to form the largest quorum required by the law applicable to that political subdivision. Should only one member of the governing body or only one standby officer be available, that one shall have power to reconstitute the governing body.

(c) Proceed to reconstitute the political subdivision by appointment of qualified persons to fill vacancies.

(d) Proceed to perform its functions in the preservation of law and order and in the furnishing of local services.

(Amended by Stats. 1974, Ch. 595.)

8644. Should all members of the governing body, including all standby members, be unavailable, temporary officers shall be appointed to serve until a regular member or a standby member becomes available or until the election or appointment of a new regular or standby member. Temporary officers shall be appointed as follows:

(a) By the chairman of the board of supervisors of the county in which the political subdivision is located, and if he is unavailable,

(b) By the chairman of the board of supervisors of any other county within 150 miles of the political subdivision, beginning with the nearest and most populated county and going to the farthest and least populated, and if he is unavailable,

(c) By the mayor of any city within 150 miles of the political subdivision, beginning with the nearest and most populated city and going to the farthest and least populated.

(Added by Stats. 1970, Ch. 1454.)



Contra
Costa
County

To: Board of Supervisors
From: John Kopchik, Director, Conservation & Development Department
Date: March 8, 2022

Subject: Approval of Participation in California Microenterprise Relief Fund Program through Chabot-Las Positas Community College District for \$1.4 million

RECOMMENDATION(S):

APPROVE participation in the California Office of the Small Business Advocate's California Microbusiness COVID-19 Relief Grant Program through delegating program administration to Chabot-Las Positas Community College District (District), and AUTHORIZE the Director of Conservation and Development to send a letter of support for the District's application on behalf of the County, to give local microenterprises access to the \$1,454,492 in funds allocated to Contra Costa County.

FISCAL IMPACT:

No direct fiscal impact to the County. Potential to infuse local economy with more than \$1.4 million in spending power through December 2022.

BACKGROUND:

The California Microbusiness COVID-19 Relief Grant Program is a one-time \$50 million grant program that will provide \$2,500 grants to eligible microbusinesses in California. The funding must all be expended by November 30, 2022. Contra Costa businesses are allocated \$1,454,492.29 under the State's formula. Eligible businesses have \$50,000 or less in annual revenue, were in operation in 2019, and have 5 or fewer employees; for example, pop-up retail and food vendors are good candidates although funding is available to any business that matches the size parameters. The State issued a Request for Proposals from eligible entities to manage the county-level allocations with responses due March 10.

The County is not geared up to administer this type of program itself, but has been approached by one eligible fiscal agent, the Chabot-Las Positas Community College District (District), which is putting together a consortium application. Due to the time constraints in getting these funds to eligible business owners, staff recommends sending a letter of support to the State delegating the County's allocation to the District, which will then be responsible for administering the program in Contra Costa County. The contractual relationship would be between the District and the State, and the County would not be a party to the contract. The Department of Conservation and Development will prepare the letter of support (draft attached) for the Director's signature, pending approval of this item.

APPROVE

OTHER

RECOMMENDATION OF CNTY ADMINISTRATOR

RECOMMENDATION OF BOARD COMMITTEE

Action of Board On: **03/08/2022** APPROVED AS RECOMMENDED OTHER

Clerks Notes:

VOTE OF SUPERVISORS

AYE: John Gioia, District I Supervisor
Candace Andersen, District II Supervisor
Diane Burgis, District III Supervisor
Karen Mitchoff, District IV Supervisor
Federal D. Glover, District V Supervisor

I hereby certify that this is a true and correct copy of an action taken and entered on the minutes of the Board of Supervisors on the date shown.

ATTESTED: March 8, 2022
Monica Nino, County Administrator and Clerk of the Board of Supervisors

Contact: Amalia Cunningham,
925-655-2881

By: Stacey M. Boyd, Deputy

cc:

BACKGROUND: (CONT'D)

In preliminary discussions with District staff, County economic development staff has emphasized the need to partner with local-serving small business organizations to help market the program and solicit applications from eligible businesses. If this is approved, the District may use up to 20% of the award (\$290,898.46) for administrative costs and has indicated willingness to use those funds for marketing support in Contra Costa County. With awards of \$2,500 per business, this program could fund 465 microenterprises. Infrastructure will be in place to market across all socio-economic groups in Contra Costa County with the intent of total grant dollars being disbursed to the microbusinesses. The District will market the program, vet recipients, disburse grants, and provide reporting to the State and Contra Costa County's Department of Conservation and Development.

The District is also working with Alameda County to act as its agent to administer the Program in that jurisdiction, along with six more counties. Chabot-Las Positas Community College District's Economic Development and Contract Education Department has been serving as a Fiscal Agent since 2012 and has managed approximately \$250 million in fiscal agreements annually focused on education, child welfare, community outreach and diversity.

CONSEQUENCE OF NEGATIVE ACTION:

If this item is not approved, eligible businesses in Contra Costa County would lose out on individual awards of \$2,500, and up to \$1.454 million total.

ATTACHMENTS

Letter of support (draft)

Chabot-Las Positas Community College District Fiscal Agent flyer

March 8, 2022

Office of the Small Business Advocate
Governor's Office of Business and Economic Development
1325 J Street, Suite 1800
Sacramento, CA 95814

Re: Contra Costa County Microbusiness COVID-19 Relief Grant

Dear Cal-OSBA:

Contra Costa County submits this letter in support of Chabot-Las Positas Community College District to act on our behalf for the Microbusiness COVID-19 Relief Grant Program.

This designation of approval for Chabot-Las Positas Community College District will be to provide \$2,500 grants to eligible microbusinesses impacted by COVID-19 and related health and safety restrictions in Contra Costa County.

Sincerely,

John Kopchik
Director, Department of Conservation and Development

Chabot-Las Positas Community College District

Fiscal Agent of Choice

If you are looking for a partner to accept grants and manage funds in support of your mission, you can trust the experienced Chabot-Las Positas Community College District (CLPCCD) Fiscal Agency team to deliver the expertise and customer service you require.



Strategic Systems to Collect Program Data

We work with you on the project from Day One to create a system that gathers and tracks *only* the data you need and *all* of the data you need.



100% Accessible & Understandable Data

We create cloud-based documentation for your program to track all expenditures, commitments and fund balances. Records are available to authorized personnel at any time for real-time decision making about your funds.



Seamless Customer Service

We support your fiscal project manager so that they can be confident data is available when you need it, whether it's for a government review, SOX audit or a Board report.



Our Track Record Speaks for Itself

We have managed dozens of contracts and well over \$250 million in projects. Our clients say they return to us for our accurate record keeping, honesty, dependability and confidentiality.

We walk side-by-side with you through the initial receipt of funds, ongoing program distributions and final reports. Whether you're in the middle of a program or about to begin something new, we're happy to help at any stage of your program.

(925) 416-5143, fiscalagent4you@clpccd.org.



Contra
Costa
County

To: Board of Supervisors
From: David O. Livingston, Sheriff-Coroner
Date: March 8, 2022

Subject: Emergency Siren Site License with CC Community College District

RECOMMENDATION(S):

APPROVE and AUTHORIZE the Sheriff-Coroner, or designee to enter into a Site License Agreement with the Contra Costa Community College District to allow the County, through the Office of the Sheriff, to install, access, and maintain outdoor emergency sirens on property owned by the Contra Costa Community College District commencing on March 8, 2022, and renewing automatically on a yearly basis.

FISCAL IMPACT:

This is a nonfinancial agreement. The costs to install and maintain the outdoor emergency sirens is budgeted within the Sheriff's Office and is funded through the Contra Costa County Certified Unified Program Agency (CUPA).

BACKGROUND:

The Office of the Sheriff Office of Emergency Services desires to install an outdoor emergency siren on property owned by the Contra Costa Community College District (4CD) building on the exterior of the roof, for use by licensee to warn the surrounding public in downtown Martinez if an emergency, specifically during major hazardous materials releases in the area. This siren is to replace the existing siren located on the roof of 651 Pine Street, which is slated for

APPROVE

OTHER

RECOMMENDATION OF CNTY ADMINISTRATOR

RECOMMENDATION OF BOARD COMMITTEE

Action of Board On: **03/08/2022** APPROVED AS RECOMMENDED OTHER

Clerks Notes:

VOTE OF SUPERVISORS

AYE: John Gioia, District I Supervisor
Candace Andersen, District II Supervisor
Diane Burgis, District III Supervisor
Karen Mitchoff, District IV Supervisor
Federal D. Glover, District V Supervisor

I hereby certify that this is a true and correct copy of an action taken and entered on the minutes of the Board of Supervisors on the date shown.

ATTESTED: March 8, 2022

Monica Nino, County Administrator and Clerk of the Board of Supervisors

By: Stacey M. Boyd, Deputy

Contact: Chrystine Robbins, 925-655-0008

cc:

BACKGROUND: (CONT'D)

demolition sometime in 2022. This siren is one of many in a network of sirens in and around major hazardous material facilities that can be used during major hazardous materials releases.

The 4CD building has been selected for several reasons, including its proximity to 651 Pine Street and the existing siren. This building has more stories than surrounding buildings, allowing the siren sound wave to travel a comparable distance and at a comparable decibel level of the existing siren, while avoiding using buildings with more restrictive access such as Court buildings or the Martinez Detention Facility. Finally, this building is already equipped with power and hosts other outside communication equipment.

CONSEQUENCE OF NEGATIVE ACTION:

If unapproved, the county will be unable to efficiently provide siren coverage for the downtown Martinez area during hazardous materials emergencies. The sirens have long been socialized in communities around hazardous materials facilities and necessary to provide a continued level of expected alert and warning in the area.

CHILDREN'S IMPACT STATEMENT:

None



Contra
Costa
County

To: Board of Supervisors
From: David O. Livingston, Sheriff-Coroner
Date: March 8, 2022

Subject: Receive the Sheriff-Coroner's FY 2020-2021 Annual P-6 Zone Deployment Report

RECOMMENDATION(S):

Receive the Sheriff-Coroner's FY 2020/21 Annual P-6 Zone Deployment Report, from the County Service Area (CSA) P-6 Zone Central Administrative Base (CAB) Fund to provide extended police protection services in certain unincorporated county areas and partially fund the Sheriff's Helicopter Program, as required by P-6 Zone CAB Formation Board Order of April 19, 1998.

FISCAL IMPACT:

This is an informational item only. The activities included in this report are funded 100% by County Service Area (CSA) P-6 Central Administrative Base (CAB) Fund (Fund No. 262900). Total costs of \$1,410,407 were expended in 2020/2021.

BACKGROUND:

The Office of the Sheriff annually reviews funding for County Service Area (CSA) P-6 Zones county-wide and implemented and budgeted the following expenditures for fiscal year 2020/2021:

Discovery Bay: CSA P-6 Zones in the Discovery Bay area generate \$851,487 per year. Costs for personnel currently assigned to Discovery Bay (2 Deputy Sheriffs, 1 Sheriff's Specialist and 1 Sheriff Community Service Officer), vehicle and supplies are \$738,477.

This will require the expenditure of funds from the P-6 Central Administrative Base (CAB) Fund. Discovery Bay zones currently have accumulated approximately \$1,880,545 in reserve funding located in the CSA P-6 Central Administrative Base Fund (Fund No. 262900).

APPROVE

OTHER

RECOMMENDATION OF CNTY ADMINISTRATOR

RECOMMENDATION OF BOARD COMMITTEE

Action of Board On: **03/08/2022** APPROVED AS RECOMMENDED OTHER

Clerks Notes:

VOTE OF SUPERVISORS

AYE: John Gioia, District I Supervisor
Candace Andersen, District II Supervisor
Diane Burgis, District III Supervisor
Karen Mitchoff, District IV Supervisor
Federal D. Glover, District V Supervisor

I hereby certify that this is a true and correct copy of an action taken and entered on the minutes of the Board of Supervisors on the date shown.

ATTESTED: March 8, 2022

, County Administrator and Clerk of the Board of Supervisors

By: Stacey M. Boyd, Deputy

Contact: Heike Anderson, (925) 655-0023

cc: Heike Anderson, Alycia Rubio, Paul Reyes

BACKGROUND: (CONT'D)

Bay Point: CSA P-6 Zones in the Bay Point Area generate \$223,634 per year. Costs for personnel assigned to Bay Point (1 Deputy Sheriff), vehicle and supplies are \$253,066.

North Richmond/San Pablo: CSA P-6 zones in the North Richmond/San Pablo area generate \$90,746 per year. North Richmond/San Pablo zones partially fund 1 Deputy Sheriff, vehicle and supplies at \$38,979 annually.

STARR 1 Helicopter Program: As in past years, we augmented State Supplemental Law Enforcement Services Fund (SLESF) funding to operate the helicopter program without the use of County General Funds, using \$379,634 of P-6 Zone Funds for this purpose.

Administrative Expenses: Assessment and Investment expenses, zone closing expenses and election charges for all the zones. Total cost of \$252.

CONSEQUENCE OF NEGATIVE ACTION:

Negative action would result in the displacement of existing personnel assigned to the communities of Discovery Bay, Bay Point, North Richmond/San Pablo and Pacheco. The Sheriff's STARR 1 helicopter may have reduced flight hours depending on revenue streams from other sources.

CHILDREN'S IMPACT STATEMENT:

No impact.



Contra
Costa
County

To: Board of Supervisors
From: John Kopchik, Director, Conservation & Development Department
Date: March 8, 2022

Subject: Ballot Arguments Related to the Contra Costa County Abandoned Vehicle Abatement Program and Fee.

RECOMMENDATION(S):

AUTHORIZE the Board Chair to sign, on behalf of the Board of Supervisors, the argument in favor and any associated rebuttal argument related to a tax measure on the June 7, 2022 election ballot that would extend the Contra Costa County Abandoned Vehicle Abatement Program and Fee.

FISCAL IMPACT:

None

BACKGROUND:

The County and all 19 cities within the County are members of the Contra Costa County Abandoned Vehicle Abatement Service Authority ("Authority"). The Authority was formed in 1991 to implement the Contra Costa County Abandoned Vehicle Abatement Program ("Program") for the purpose of abating, removing and disposing of any abandoned, wrecked, dismantled, or inoperative vehicles or vehicle parts from Contra Costa County communities.

The Authority's activities are funded through a \$1 fee levied annually on every registered vehicle within the County, and an \$2 additional fee levied on certain commercial vehicles registered within the County ("Fee"). This Fee must be

APPROVE

OTHER

RECOMMENDATION OF CNTY ADMINISTRATOR

RECOMMENDATION OF BOARD COMMITTEE

Action of Board On: **03/08/2022** APPROVED AS RECOMMENDED OTHER

Clerks Notes:

VOTE OF SUPERVISORS

AYE: John Gioia, District I Supervisor
Candace Andersen, District II Supervisor
Diane Burgis, District III Supervisor
Karen Mitchoff, District IV Supervisor
Federal D. Glover, District V Supervisor

I hereby certify that this is a true and correct copy of an action taken and entered on the minutes of the Board of Supervisors on the date shown.

ATTESTED: March 8, 2022

Monica Nino, County Administrator and Clerk of the Board of Supervisors

By: Stacey M. Boyd, Deputy

Contact: Jason Crapo, 925 655-2800

cc:

BACKGROUND: (CONT'D)

reauthorized and extended by the Authority every 10 years. The Fee is set to expire on April 30, 2022.

The Fee also needs to be reauthorized by the voters of Contra Costa County. In 2010, the voters of California approved Proposition 26, which amended the definition of a "tax." The Fee collected to fund the Authority's activities is a special tax under Prop. 26, and the extension of the Fee requires an election and approval by two-thirds of county voters.

On October 5, 2021, the Board of Supervisors, as a member-agency of the Authority, adopted a resolution extending the Program and Fee for 10 years to April 30, 2032, and authorizing the Authority to take all actions necessary to place a tax measure on the June 7, 2022 election ballot to extend the fee. All 19 Cities within the County have adopted similar resolutions supporting the extension of the Program and Fee. On December 8, 2021, the Authority adopted a resolution authorizing a tax measure be placed on the June 7, 2022 election ballot.

Members of a governing body, members on behalf of a bona fide association, and any voter eligible to vote on the measure can submit an argument signed by up to five people. Only one argument in favor and one argument against can be published in the voter guide. Arguments are limited to 300 words. The argument in favor is an opportunity to explain to the voters why they should vote in favor of the measure and extend the Fee. Attached is a suggested argument in favor of the measure to extend the Program and Fee.

Staff recommends that the Board of Supervisors authorize the Board Chair to sign, on behalf of the Board, the argument in favor. Staff also recommends that the Board of Supervisors authorize the Board Chair to develop and sign any associated rebuttal argument to an argument against the measure that may be submitted.

CONSEQUENCE OF NEGATIVE ACTION:

If the recommended actions are not approved, the Chair of the Board will not be authorized to sign the argument in favor or any associated rebuttal argument related to a tax measure on the June 7, 2022 election ballot to extend the Program and Fee.

ATTACHMENTS

Suggested Argument in Favor

Vote YES on Measure __ to remove abandoned and wrecked vehicles from Contra Costa communities.

Measure __ extends the existing Contra Costa County Abandoned Vehicle Abatement Program that removes and disposes of abandoned and wrecked vehicles in Contra Costa County. These abandoned vehicles are public nuisances that lead to blighted neighborhoods and unsafe streets. Contra Costa County and every city in the County participates in the Program to keep our communities cleaner and safer. This Program has existed for more than 30 years. Over the past decade, the Program has removed more than 40,000 abandoned and wrecked vehicles from Contra Costa County communities.

The Contra Costa County Abandoned Vehicle Abatement Program is currently funded by an existing annual fee of \$1 for each vehicle registered in Contra Costa County, and an additional \$2 for certain commercial vehicles registered in Contra Costa County. The fees are paid at the time of vehicle registration.

Measure __ extends the Program and existing annual fee until April 30, 2032, but does not create any new fee or increase the current fee.

Measure __ will generate \$11 million of local funding over 10 years to remove and dispose of abandoned, wrecked, dismantled, or inoperative vehicles. The County and each city controls a portion of the funding for its activities under the Program.

Every city in Contra Costa County voted to support Measure __ and authorize the extension of the Contra Costa County Abandoned Vehicle Abatement Program.

Keep our communities clean and safe!

Vote YES on Measure __!