

**MACKENZIE & ALBRITTON LLP**

155 SANSOME STREET, SUITE 800  
SAN FRANCISCO, CALIFORNIA 94104

---

TELEPHONE 415 / 288-4000  
FACSIMILE 415 / 288-4010

February 20, 2019

**VIA EMAIL**

Chair John Gioia  
Vice-Chair Candace Andersen  
Supervisors Diane Burgis,  
Karen Mitchoff, and Federal D. Glover  
Board of Supervisors  
Contra Costa County  
651 Pine Street  
Martinez, California 94553

Re: Verizon Wireless Response to Appeals of Approved Small Cell  
Wireless Facilities in the Right-of-Way  
County Files WA18-0002 (401 Horsetrail Court); WA18-0004 (1524  
Alamo Way); WA17-0013 (184 Creekdale Road); WA18-0003 (1955  
Meadow Road); WA17-0008 (20 Francesca Way)  
Board of Supervisors Agenda February 26, 2019

Dear Chair Gioia, Vice-Chair Andersen and Supervisors:

We write on behalf of Verizon Wireless to ask you to uphold the Zoning Administrator's and Planning Commission's approvals of five proposed small cell wireless facilities (collectively, the "Approved Facilities"). The Approved Facilities will be installed on existing utility poles in the public rights-of-way near 401 Horsetrail Court in Alamo, 1524 Alamo Way in Alamo, 184 Creekdale Road in Walnut Creek, 1955 Meadow Road in Walnut Creek, and 20 Francesca Way in Alamo. The Approved Facilities consist of small equipment and antennas attached to existing utility infrastructure in the right-of-way. They will have no significant visual impact, and they meet all findings for approval of a wireless access permit under the Contra Costa County Ordinance Code (the "Code").

Each of the Approved Facilities have been appealed by a neighbor (collectively, the "Appellants"). The appeals raise no conflict with the Code and do not provide substantial evidence to warrant denial of the wireless access permits as required under the federal Telecommunications Act. The Approved Facilities will provide an important public benefit by enhancing Verizon Wireless service for residents, visitors, and emergency service personnel in Contra Costa County. Accordingly, denial would constitute an effective prohibition of service in conflict with the Telecommunications Act. We urge you to reject the appeals and uphold the Planning Commission's approvals.

## **I. The Approved Facilities**

The Approved Facilities have been thoughtfully designed to minimize any impact to the surrounding neighborhood. Each of them involves installing an antenna atop an existing wooden utility pole and attaching accessory equipment on the side of the pole.

For the Approved Facilities located at 1524 Alamo Way and 184 Creekdale Road, Verizon Wireless proposes two-foot tall antennas to minimize visual impact. The Approved Facilities at 401 Horsetrail Court, 1955 Meadow Road, and 20 Francesca Way require four-foot antennas to optimize signal propagation. Each antenna will be elevated at least six feet above pole-top electrical conductors to meet safety clearances required by California Public Utilities Code General Order 95, Rule 94. For each of the Approved Facilities, the height increase, including antennas, will be 10 feet or less as required by Code Section 88-24.408(f)(2)(C).

For four of the Approved Facilities, all associated equipment will be placed on the side of the pole (1524 Alamo Way, 401 Horsetrail Court, 1955 Meadow Road, and 20 Francesca Way). Two remote radio units ("RRUs") will be stacked vertically between 8 to 18 feet on the pole and concealed behind a narrow shroud painted to match the pole. Below the shroud, there will be a small disconnect switch and minor ancillary equipment, as depicted in the plans. The lowest equipment component is eight feet above ground.

For the Approved Facility near 184 Creekdale Road, the Planning Department requested that Verizon Wireless locate the support equipment on the ground rather than mounting them to the pole. The Engineering Services Division of the County Public Works Department supports a ground enclosure for this particular location. Consequently, this facility will include RRUs, a power meter, and other ancillary equipment in a small 4'-4" by 7'-10" ground equipment area near the pole, fully screened by a 6-foot redwood slat fence. The only equipment on the side of this pole will be a ground bus bar and disconnect switch.

We have attached photosimulations of the Approved Facilities to confirm their insignificant visual impact. Indeed, the Approved Facilities are "low-visibility facilities," as defined by the Code. Code § 88-24.204(p)(4). We have also attached reports prepared by Hammett & Edison, Inc., Consulting Engineers, which confirm that radio frequency ("RF") exposure levels from the Approved Facilities will comply with Federal Communications Commission ("FCC") guidelines. The Approved Facilities will generate no noise as the equipment involves no moving parts.

## **II. The Approved Facilities Meet All Findings and Design Standards for a Wireless Access Permit**

As confirmed by the Zoning Administrator's and Planning Commission's approvals, the Approved Facilities meet all findings for wireless access permits. Code § 88-24.612(b)(4)(A). They comply with the height restriction (Code § 88-24.408(f)(2)(C)), and also include concealing shrouds to improve appearance and reduce visual impact (Code § 88-24.408(f)(2)(F)). The Approved Facilities do not interfere with use of the right-of-way, as pole-mounted equipment is elevated above any pedestrian walkway and vehicular line-of-sight, and the single ground enclosure for one facility is placed over four feet behind the curb, away from the roadway. In sum, Verizon Wireless's Approved Facilities comply with all applicable County regulations.

## **III. State and Federal Law Support Approval of the Approved Facilities**

### **A. Verizon Wireless is Authorized to Place the Approved Facilities in the Public Right-of-Way Pursuant to State Law**

State law entitles Verizon Wireless to install telephone equipment, such as the Approved Facilities, "along any public road and highway," subject only to reasonable local regulations to avoid interference with the public use of the right-of-way. Cal. Pub. Util. Code § 7901. The California Supreme Court is currently considering whether this includes any local discretion with respect to aesthetics in *T-Mobile West LLC v. City and County of San Francisco* (2016) 3 Cal.App.5th 334 (Case No. S238001).

### **B. Federal Law Requires Substantial Evidence for Denial**

Pursuant to the federal Telecommunications Act (the "TCA"), a local government's denial of a wireless facility application must be based on "substantial evidence." See 47 U.S.C. § 332(c)(7)(B)(iii). Federal Courts have held that denial of an application must be based on requirements set forth in the local code and supported by evidence in the record. See *Metro PCS, Inc. v. City and County of San Francisco*, 400 F.3d 715, 725 (9th Cir. 2005) (denial of application must be "authorized by applicable local regulations and supported by a reasonable amount of evidence"). While federal law permits a local government to regulate the placement of wireless facilities based on aesthetics, mere generalized concerns or opinions about aesthetics or compatibility with a neighborhood do not constitute substantial evidence upon which a local government could deny a permit. See *City of Rancho Palos Verdes v. Abrams* (2002) 101 Cal. App. 4th 367, 381.

As documented in Verizon Wireless's application, letters, and the County's staff reports, Verizon Wireless has provided substantial evidence to show that the Approved Facilities comply with all requirements for approval under the Code. Among other evidence, photosimulations demonstrate the minimal visual impact of placing small cells on existing utility poles. Architectural drawings confirm compliance with County design criteria. The Approved Facilities will not generate any noise, and reports by Hammett & Edison confirm that RF emissions will comply with FCC guidelines.

C. Denial Would Constitute an Unlawful Prohibition of Service

Among other things, the federal Telecommunications Act provides that local government regulation of wireless facilities “shall not prohibit or have the effect of prohibiting” the provision of personal wireless service. 47 U.S.C. § 332(c)(7)(B)(i)(II). Under Ninth Circuit case law, a local government violates this clause of the TCA if the wireless provider can show two things: (1) that it has a “significant gap” in service; and (2) that the proposed facility is the “least intrusive means,” in relation to the land use values embodied in local regulations, to address the gap. See *T-Mobile USA, Inc. v. City of Anacortes*, 572 F.3d 987 (9th Cir. 2009).

In a recent Declaratory Ruling, the FCC determined that the Ninth Circuit’s two-part test is too narrow. See *In the Matter of Accelerating Wireless Broadband Deployment by Removing Barriers to Infrastructure Investment, Declaratory Ruling and Third Report and Order*, FCC 18-133, WT Docket No. 17-79 and WC Docket No. 17-84 (September 27, 2018) (the “*Small Cell Order*”). In the *Small Cell Order*, which became effective on January 14, 2019, the FCC confirmed that a wireless carrier need not show an insurmountable barrier, or even a significant gap, to prove a prohibition of service. *Small Cell Order*, ¶¶ 35, 38. Instead, “a state or local legal requirement constitutes an effective prohibition if it ‘materially limits or inhibits the ability of any competitor or potential competitor to compete in a fair and balanced legal and regulatory environment.’” *Id.*, ¶ 35. Thus, state or local regulations are preempted if they materially inhibit “densifying a wireless network, introducing new services, or otherwise improving service capabilities.” *Id.*, ¶ 37.

In this case, denial would not survive judicial review under this standard. As we will explain, denial of these applications would materially inhibit Verizon Wireless’s ability to improve service on its network.

As described in the *Verizon Wireless Radio Frequency Engineer’s Site Justification*, attached as Exhibit A (the “RF Engineer’s Statement”), the Approved Facilities will provide improved coverage and offload demand from four existing facilities. These existing facilities have already hit capacity. The response from a text campaign sent to customers in the area, attached as Exhibit B, confirms the need for the Approved Facilities. Because signal strength falls off rapidly with distance, the Approved Facilities will improve service to users in their vicinity, resulting in increased data speeds, improved call quality, and overall increased network capacity for the Alamo network. From the user’s perspective, all of this means more reliable service, with fewer dropped calls and data connections, especially during high traffic hours. Denial of the applications would prevent Verizon Wireless from providing these improvements to its service, and therefore effectively prohibit service in violation of the Telecommunications Act. See 47 U.S.C. § 332(c)(7)(B)(i)(II); *Small Cell Order*, ¶¶ 35, 37.<sup>1</sup>

---

<sup>1</sup> In rejecting the Ninth Circuit’s significant gap/least intrusive means test, the *Small Cell Order* made the question of alternative sites irrelevant to effective prohibition analysis. But even if alternatives were still

**V. None of the Appeals Present Substantial Evidence to Warrant Denial**

As confirmed by the Zoning Administrator and Planning Commission, the Approved Facilities comply with all Code standards for wireless facilities. As we will demonstrate, the concerns raised by Appellants are meritless and none of them are supported by substantial evidence for denial of the applications.

A. The Appeal of 401 Horsetrail Court, Alamo

Dr. Alice Lee, on behalf of herself and some of her neighbors, has raised several concerns regarding the Approved Facility near 401 Horsetrail Court. As we explain, none have any merit.

1. The Approved Facility Will Present Minimal Visual Impact

Aesthetics appear to be at the forefront of Dr. Lee's concerns. She claims that the Approved Facility at 401 Horsetrail Court in Alamo "would aesthetically clash" with Alamo's "bucolic country lifestyle." This claim is fanciful, as the photosimulations (see Exhibit C) and plans demonstrate the *de minimis* visual impact of Verizon Wireless's small cell placed on existing utility infrastructure in the right-of-way, screened by an adjacent tree. Additionally, the approved plans demonstrate compliance with County standards, including height limits.

As discussed above, state law allows cell phone providers to place their facilities in public rights-of-way, and whether local governments retain any authority to apply aesthetic standards in this context is currently under review by the California Supreme Court. Despite this uncertainty, Verizon Wireless analyzed multiple locations within the target area to find the site that would meet the engineering objective, PG&E, General Order 95 rules and regulations and with the least visual impacts. The residential neighborhood surrounding 401 Horsetrail Court has tree-lined streets with existing wooden utility poles and a matrix of overhead transmission lines. Attaching small equipment to one of these poles is entirely consistent with this setting, as both the Zoning Administrator and Planning Commission approvals confirm.

The Planning Commission also attached several Conditions of Approval to the Approved Facility to ensure that the Approved Facility will have minimal aesthetic impacts:

12. The equipment shall be maintained in good condition over the term of the permit. This shall include keeping the structures graffiti-free.
13. Antennas, towers, cabinets, and mountings shall not be used for advertising.

---

relevant, the result would be the same. As discussed above and explained in more detail below, there is no feasible, less intrusive alternative to the Approved Facilities.

14. No lights or beacons may be installed on any antenna or antenna support structure. . . .

15. . . . Equipment must be painted to match the utility pole.

. . . . .

17. All proposed antennas, antenna supports, and conduits shall have a non-reflective finish. Paints with a reflectivity less than 55 percent are required. Color photographs showing the as-built condition shall be submitted for review of the CDD staff to verify compliance with this Condition of Approval within 30 days of completing construction.

Photosimulations demonstrate the minimal impact of this facility. Planning Staff found that the Approved Facility poses little impact due to its stealth design and is consistent with Code requirements, and the Zoning Administrator and Planning Commission agreed. Their approvals were based on substantial evidence, and Dr. Lee's claims of aesthetic impacts are not. Her appeal does not raise any inconsistency with the Code and must be rejected.

## 2. Verizon Wireless Does Not Have To Demonstrate Need

Dr. Lee also questions the need for the Approved Facilities, claiming there is no shortfall in wireless service or a need for increased service to a stable population. The Approved Facilities will improve in-building and in-vehicle Verizon Wireless coverage for residents and visitors to the area, and they will enhance reliable communications with emergency service personnel. As use of wireless devices increases far faster than population growth, the Approved Facilities will provide expanded network capacity to meet demand. As noted above, Public Utilities Code Section 7901 grants telephone corporations such as Verizon Wireless a statewide right to place their telephone equipment in any public right-of-way. Because of this statewide right, Verizon Wireless need not prove the necessity of its right-of-way facilities. Consistent with state law, none of the Code's findings for a wireless access permit require a demonstration of need. This ground for appeal raises an irrelevant subject and must be rejected.

## 3. The Approved Facility Complies with FCC Radio Frequency Exposure Guidelines

Dr. Lee also expresses concerns about RF emissions and requests annual testing of the Approved Facilities. These concerns are also unfounded, as well as preempted by federal law.

First, the County may not consider RF emissions as a ground upon which to deny the Approved Facility because it complies with FCC guidelines. *See* 47 U.S.C. § 332(c)(7)(B)(iv). For this Approved Facility, the attached RF report prepared by Hammett & Edison, Inc., Consulting Engineers, demonstrates that the calculated exposure levels are well below the FCC's thresholds. For a person anywhere at ground, the maximum RF exposure level is calculated to be 0.12% of the applicable public exposure limit, and the maximum calculated level at the second-floor elevation of any nearby building is 0.14% of the public exposure limit. These results are conservative, as

they include several “worst-case” assumptions. Consequently, they are expected to overstate the emissions.

Furthermore, local jurisdictions cannot require serial emission tests, as regulation of wireless devices is preempted by the federal government. *See e.g., Crown Castle USA Inc. v. City of Calabasas* (Los Angeles Superior Court BS140933, 2014) (“...the regulation of a facility’s planned or ongoing operation constitutes an unlawful supplemental regulation into an area of federal preemption.”) The FCC has exclusive jurisdiction over the technical and operational aspects of wireless facilities. Once a facility has been shown to comply with FCC exposure guidelines, any requirement to demonstrate compliance again through ongoing or periodic measurements exceeds the County’s authority. It is also unnecessary unless there has been a change in equipment, in which case a new report would be required.

Aside from federal preemption, the annual measurement condition is not required by the Code. Code Article 88-24.2. During development of the County’s wireless ordinance in 2015-2016, our firm provided comment on behalf of Verizon Wireless and worked closely with Planning staff to devise a new compliance provision. The County approved a compromise: every five years, a permittee must certify that “the facility is in compliance with all applicable county permits, county ordinances, and state and federal laws and regulations.” Code § 88-24.414(h). This requirement, which is the most the County may require, is reflected in the conditions of approval for each application.

#### 4. Alleged Impact on Property Values is Preempted as a Proxy for Concerns Over Radio Frequency Emissions

Next, Dr. Lee claims that property values will allegedly decrease as a result of the Approved Facilities, implying that concerns over RF emissions would negatively impact property values.

As a preliminary matter, decreased property values cannot support denial of the applications, as “concern over the decrease in property values may not be considered as substantial evidence if the fear of property value depreciation is based on concern over the health effects caused by RF emissions.” *AT&T Wireless Servs. of Cal. LLC v. City of Carlsbad*, 308 F. Supp. 2d 1148, 1159 (S.D. Cal. 2003); *see also Calif. RSA No. 4, d/b/a Verizon Wireless v. Madera County*, 332 F. Supp. 2d 1291, 1311 (E.D. Cal. 2003).

Notably though, some studies suggest that proximity to a cell tower *increases* property values. For example, a 2015 study surveying 2,000 U.S. adults found that they “care more about cell phone reception than the quality of neighborhood schools when buying a home.”<sup>2</sup> Locally, the Joint Venture Silicon Valley Network conducted a study with the Santa Clara County Association of Realtors and the Silicon Valley Association

---

<sup>2</sup> Available at: <http://time.com/money/3904761/buy-home-good-cell-mobile-reception/> and <http://www.rootmetrics.com/en-US/content/home-buying-wish-list-70s-appliances-out-good-mobile-signal-in>

with Realtors in 2012.<sup>3</sup> That study found that “[i]t is quite clear from the data that the distance from a wireless facility has no apparent impact on the value or sale price of a home.” *Id.* at p. 5.

In short, Dr. Lee’s concern regarding decreased property values is unfounded and preempted by federal law. It is also irrelevant to the findings for a wireless access permit.

#### 5. The Approved Facility Will Be Structurally Safe

Dr. Lee also raises unfounded safety concerns, claiming a small cell could pose a danger by catching fire or falling. As required by state law, Pacific Gas & Electric engineers, in cooperation with Verizon Wireless, must confirm the structural capacity of each proposed utility pole to determine whether it is structurally sufficient or must be replaced. The conditions of approval require both a building permit and encroachment permit for the Approved Facility. The County will evaluate compliance with building codes and fire safety during review of the permit application, with approval by the Contra Costa County Fire Protection District required before a building permit is issued. Dr. Lee’s concern over safety is groundless and must be dismissed.

Dr. Lee and other appellants also point to CPUC findings that overloading of telecommunication equipment and aging telephone poles caused or contributed to the 2007 Malibu fire. Since that time the CPUC has updated General Order 95 to address engineering standards and structural safety. Because of the multiple layers of structural review for the Approved Facilities and because these issues are beyond the scope of a wireless permit, this concern does not present a ground upon which the County can deny the permit.

#### 6. The Subject Pole is the Least Intrusive Means

California Public Utilities Code Section 7901 grants telephone corporations the right to place their telephone equipment “along and upon any public road or highway,” so long as they do not interfere with the public’s use of the right-of-way. Under this state law, alternative sites are irrelevant because the Approved Facility will not interfere with public use of the right-of-way. Nonetheless, Verizon Wireless reviewed alternatives in the right-of-way within the coverage objective of the Approved Facility in order to select the pole that will result in the least impacts to community. Alternatives are typically other utility poles within a short distance from the original selection. Any alternative must also meet the radio frequency objective and comply with PG&E rules and regulations.

The first alternative pole considered is located approximately 195 feet north of the subject pole. This utility pole is already occupied by AT&T and PG&E. Because it already supports three risers, PG&E will not allow a new facility on this pole.

---

<sup>3</sup> Available at: <https://jointventure.org/images/stories/pdf/wireless-facilities-impact-on-property-values.pdf>



The next alternative analyzed is a PG&E utility pole approximately 150 feet south of the subject pole. PG&E will not allow Verizon Wireless to use this pole because it has a “cut-out”, which is essentially a pole-top fuse. See attached PG&E Guidelines, General Information Item 5 (Exhibit H). The pole also already supports multiple power and telecommunications wires running in three directions and three guy wires. In sum, PG&E will not allow Verizon Wireless to locate on either one of the adjacent poles.

B. The Appeal of 1524 Alamo Way, Alamo Presents No Substantial Evidence to Warrant Denial

Mike and Joan Parodi (the “Parodis”) appealed the Approved Facility proposed to be located near 1524 Alamo Way in Alamo, raising seven objections to its approval. As we discuss in detail below, none of their objections have merit.

First, the Parodis, like Dr. Lee, are concerned about the safety of the pole. Please refer to the discussion above on that point. Next, the Parodis claim there was no “public health study.” Hammett & Edison, Inc. Consulting Engineers, prepared a report dated April 13, 2018, (see Exhibit D) which confirms that the Approved Facility is well within the FCC’s exposure limits. In fact, the maximum calculated RF exposure level on the ground is 0.56% of the applicable public exposure limit, and the maximum calculated level at the nearest building is 0.94%. These results are conservative, as they include several “worst-case” assumptions. Consequently, they are expected to overstate the emissions.

The Parodis claim that the Approved Facility will somehow cause “unlimited future expansion” is also baseless. The County is obligated to process permits as they are submitted, irrespective of speculation about what other carriers may do in the future. Each permit application is – and must be – analyzed independently. To the extent this is a concern about RF emissions of any future expansion, the County will presumably require proof that those emissions will comply with FCC limits before approving any expansion.

1. The Approved Facility Does Not Encroach Upon Private Property

Next, the Parodis claim that the Approved Facility “encroaches and trespasses” upon their private property “through-air on adjacent properties interfering with the ‘ordinary use and enjoyment’ of the property.” This appears to be based on the RF signals from the facility, which they analogize to the wires used to convey electricity. As discussed above, the FCC has exclusive jurisdiction over RF emissions. Since the Hammett & Edison report confirms that the facility will comply with FCC limits on RF emissions, any concern about the allegedly harmful impacts of those emissions is preempted by federal law. As discussed above with respect to property values, this preemption also applies to any proxy for RF fears, whether property values or trespass. Finally, if the Parodis are alleging that RF emissions can constitute a trespass without allegations of harm, they are mistaken. See *San Diego Gas and Electric Co. v. Superior Court of Orange County* (1996) 13 Cal.4th 893, 936-937 (finding that homeowners failed

to state cause of action for trespass arising from electric and magnetic fields emitted from electric power lines, absent allegations of property damage).

## 2. The FCC Has Exclusive Jurisdiction Over Radio Frequency Emissions

The Parodis then attack the FCC, stating that it is not a “public health authority” and that it “has no statutory standing in defining public health standards.” The Parodis mistakenly assume that the FCC established the exposure levels in a vacuum.

The FCC’s charge is to “regulate[] interstate and international communications by radio, television, wire, satellite and cable in all 50 states, the District of Columbia and U.S. territories. An independent U.S. government agency overseen by Congress, the commission is the United States’ primary authority for communications law, regulation and technological innovation.”<sup>4</sup> Specifically, the FCC authorizes and licenses devices and facilities that generate RF radiation. “It has jurisdiction over all transmitting services in the U.S. except those specifically operated by the Federal Government.” Its “primary jurisdiction does not lie in the health and safety area, and it must rely on other agencies and organizations for guidance in these matters.”<sup>5</sup> That is exactly what the FCC did with respect to exposure thresholds:

In the United States, the FCC has adopted and used recognized safety guidelines for evaluating RF environmental exposure since 1985. Federal health and safety agencies, such as the EPA, FDA, the National Institute for Occupational Safety and Health (NIOSH) and the Occupational Safety and Health Administration (OSHA) have also been involved in monitoring and investigating issues related to RF exposure.

The FCC guidelines for human exposure to RF electromagnetic fields were derived from the recommendations of two expert organizations, the National Council on Radiation Protection and Measurements (NCRP) and the Institute of Electrical and Electronics Engineers (IEEE). Both the NCRP exposure criteria and the IEEE standard were developed by expert scientists and engineers after extensive reviews of the scientific literature related to RF biological effects. The exposure guidelines are based on thresholds for known adverse effects, and they incorporate prudent margins of safety. In adopting the current RF exposure guidelines, the FCC consulted with the EPA, FDA, OSHA and NIOSH, and obtained their support for the guidelines that the FCC is using.<sup>6</sup>

---

<sup>4</sup> Available at: <https://www.fcc.gov/about-fcc/what-we-do>

<sup>5</sup> Available at: <https://www.fcc.gov/engineering-technology/electromagnetic-compatibility-division/radio-frequency-safety/faq/rf-safety#Q9>

<sup>6</sup> Available at: <https://www.fcc.gov/engineering-technology/electromagnetic-compatibility-division/radio-frequency-safety/faq/rf-safety#Q9>

To the extent that the Appellants are concerned about RF emissions, they can and should raise those concerns in the proper forum –the FCC.

3. The County Properly Found the Approved Facilities To Be Exempt from the California Environmental Quality Act.

The Approved Facilities are exempt from the California Environmental Quality Act (Pub. Res. Code §§ 21000-21189.3) (“CEQA”). Therefore, the County need not prepare an environmental impact report (“EIR”). *See, e.g.*, Pub. Res. Code § 21084(a); 14 Cal. Code Regs. § 15300. The Approved Facilities are exempt from CEQA pursuant to the Class 1 (Existing Facilities), Class 3 (New Construction or Conversion of Small Structures), Class 11 (Accessory Structures), and “common sense” exemptions. 14 Cal. Code Regs. §§ 15301, 15303, 15311, and 15061(b)(3).

Notably, courts have repeatedly approved the application of the Class 3 exemption to wireless telecommunications projects such as the placement of 726 new utility cabinets on public sidewalks, 40 equipment cabinets on existing utility poles, and an unmanned cell tower disguised as a tree in a public park. *San Francisco Beautiful v. City and County of San Francisco* (2014) 226 Cal.App.4th 1012; *Robinson v. City and County of San Francisco* (2012) 208 Cal.App.4th 950; *Don’t Cell Our Parks v. City of San Diego* (2018) 21 Cal.App.5th 338. Likewise, the Approved Facilities are exempt from CEQA and do not require the preparation of an EIR.

4. The Parodis’s Proposed Alternative Is Infeasible

Finally, the Parodis claim that property values will decrease as a result of the Approved Facility and there is a better alternative that was not considered. With respect to property values, we have addressed this argument above under Dr. Lee’s appeal. As an allegedly superior pole, the Parodis propose an alternative 175 feet south, with vague reference to a new pole. Utility poles along the major roadway to the south carry only communications lines, not electric lines, and they are much lower in height than the proposed pole. Given the County’s limit of height extensions to 10 feet, those poles would not be sufficient to elevate antennas to the height required for adequate signal propagation. Trees immediately adjacent to those poles would impede signal, whereas the proposed pole is tall enough for the antenna to clear nearby trees. Extending electrical connections to those poles would pose additional complications given the height limit and required safety clearances. This alternative is infeasible and must be rejected.

Verizon Wireless also considered two additional alternative poles. The first one located approximately 75 feet south from the subject pole. This pole, occupied by AT&T, would have to be replaced with a taller pole to accommodate Verizon Wireless’s equipment and comply with California Public Utilities Commission General Order 95. This pole was rejected because of the aesthetic impacts associated with increasing the height of the pole and providing underground power, when a better option, the subject pole, exists. The next pole considered is located approximately 150 feet north of the

subject pole on private property. This pole was rejected because it is not in the public right-of-way.

C. The Appeal of 184 Creekdale Road, Walnut Creek Presents No Substantial Evidence to Warrant Denial

Ms. Jody Nelson appealed the Approved Facility to be located near 184 Creekdale Road in Walnut Creek. Her appeal raises many issues that have been discussed above, including the need for the facility, aesthetics, fire hazard, and real estate values. Ms. Nelson also claims that the “FCC is bullying all of us since 1996.” We have described the jurisdiction of the FCC above, as well as how they establish exposure levels. For this Approved Facility, the attached RF report (see Exhibit E) prepared by Hammett & Edison, Inc., Consulting Engineers, demonstrates that the calculated exposure levels are well below the FCC’s thresholds. For a person anywhere at ground, the maximum RF exposure level is calculated to be 1.5% of the applicable public exposure limit, and the maximum calculated level at the second-floor elevation of any nearby building is 1.1% of the public exposure limit. These results are conservative, as they include several “worst-case” assumptions. Consequently, they are expected to overstate the emissions.

Ms. Nelson also refers to the Approved Facility as a “tower” and would prefer them in commercial rather than residential districts. As explained above, the Approved Facility consists of equipment attached to an existing utility pole, not a “tower.” In addition, Verizon Wireless has the right to place telephone equipment in the public right-of-way throughout California. The Approved Facilities also fully comply with all applicable County Code requirements. Code § 88-24.408. Moreover, the Code itself defines a “Low-visibility facility” as “[a] facility or antenna installed on an existing high-voltage electricity transmission tower, or installed on an existing utility or street light pole.” Code § 88-24.204(p)(4). Therefore, the Approved Facility is inherently “low-visibility,” as defined by the Code.

1. Verizon Wireless Cannot Build A Facility That Differs From the Approved Plans

Ms. Nelson claims that Verizon Wireless “will intentionally add equipment not included in the original drawing after the initial installation” and that the County has no recourse because “Section 6409(a) has taken every bit of oversight away from local agencies.” Ms. Nelson misstates federal law. Section 6409 of The Middle Class Tax Relief and Job Creation Act of 2012 requires approval of limited modifications to a wireless facility only if they qualify as “eligible facilities requests” with no substantial change. See 47 U.S.C. § 1455(a). In 2014, the FCC issued rules interpreting Section 6409 and defining “substantial change.” 47 C.F.R. § 1.40001. The FCC limited repeated increases in height and clarified that the maximum allowed increase is based on a facility’s height as “originally approved.” 47 C.F.R. § 1.40001(b)(7)(i)(A); see also *In Re: Acceleration of Broadband Deployment by Improving Wireless Facilities Siting Policies, Etc.*, 29 FCC Rcd. 12865 (FCC October 17, 2014) (the “Spectrum Act Order”), ¶ 196.

One substantial change criterion requires that a modification not defeat the concealment elements of an existing facility. *See* 47 C.F.R. § 1.40001(b)(7)(v). For the Approved Facility, concealment elements include its narrow vertical profile design consistent with the existing utility pole. Also, a vertically-oriented equipment shroud conceals radios and cabling. Future modifications must not defeat these concealment elements as determined by the County, limiting potential expansion.

Any Section 6409 modification is subject to the County's future review and approval and beyond the scope of the present application. As this ground for appeal misconstrues federal law and bears no relation to wireless permit findings, it must be rejected.

## 2. The County Has Complied With Public Utilities Code Section 2902

Ms. Nelson also relies on California Public Utilities Code Section 2902 for the idea that "local governments still have considerable abilities to regulate these 'utilities.'" This section clarifies that a local government cannot surrender to the California Public Utilities Commission "its powers of control to supervise and regulate the relationship between a public utility and the general public in matters affecting the health, convenience, and safety of the general public" such as "the use and repair of public streets by any public utility, the location of the poles, wires, mains, or conduits of any public utility, on, under, or above any public streets, and the speed of common carriers operating within the limits of the municipal corporation." Cal. Pub. Util. Code § 2902. Neither the County nor Verizon have suggested anything to the contrary. This is why the County required excavation and building permits, and all facilities will be reviewed for fire safety and structural integrity.

## 3. Fiber Optics Cannot Replace Small Cell Facilities

Finally, Ms. Nelson also expresses a preference for fiber optics over small cells. As Ms. Nelson herself concedes, fiber optic cable provides internet to homes. Verizon Wireless's small cell facilities provide ubiquitous service for cell phone users. As noted above, the federal government has exclusive authority to regulate the technical and operational aspects of wireless service, and a resident's preference for some other technology has no bearing on this application.

## 4. The Subject Pole is the Least Intrusive Means

As noted above, alternative poles are irrelevant so long as the Approved Facility does not interfere with public use of the street, and it does not. In any case, the subject pole poses the least impacts when compared to the other poles in the vicinity. Verizon Wireless considered two poles in addition to the subject pole. The first, located approximately 230 feet west and across the street from the subject pole, is a joint PG&E and AT&T pole. This pole has cut-outs, which automatically disqualify it as viable pole, as discussed above.

The second alternative pole analyzed is located approximately 150 feet east from the subject pole and across Castle Glen Road. This pole is not viable because it already supports a host of existing lines and guy wires that will preclude the placement of Verizon Wireless's equipment on the pole. This pole is also located on a steep slope. Consequently, the subject pole is the least intrusive means to provide coverage to the area.

D. Appellant Presents No Substantial Evidence to Warrant Denial of 1955 Meadow Road, Walnut Creek

Mr. and Mrs. Donald and Anne Goldman (the "Goldmans") claim that the Approved Facility near 1955 Meadow Road in Walnut Creek is not aesthetically pleasing. They also express a preference for fiber optic cable and allege that small cell facilities will have a negative impact on property values. Finally, the Goldmans raise issues of need and safety and welfare. All of these points have been addressed above and do not warrant further discussion here.

For this Approved Facility, the attached RF report prepared by Hammett & Edison, Inc., Consulting Engineers, demonstrates that the calculated exposure levels are well below the FCC's thresholds. For a person anywhere at ground, the maximum RF exposure level is calculated to be 0.16% of the applicable public exposure limit, and the maximum calculated level at the second-floor elevation of any nearby building is 2.2% of the public exposure limit. These results are conservative, as they include several "worst-case" assumptions. Consequently, they are expected to overstate the emissions. See Exhibit F for this report and the site photosimulations.

As with the other sites referenced in this letter, Verizon Wireless analyzed the adjacent poles in order to ensure it selected the pole with the least impacts. The first alternative pole is located approximately 160 feet north of the subject pole. The pole is occupied by AT&T and PG&E. As a result, it already supports three risers and a guy wire, which occupy limited equipment and climbing space. Consequently, PG&E will not allow a new facility on this pole.

The second alternative considered is located approximately 160 feet south of the subject pole. While this pole supports less equipment, both PG&E and Verizon Wireless preferred the subject pole due to availability and RF design.

E. The Appeal of 20 Francesca Way, Alamo Presents No Substantial Evidence to Warrant Denial

Mr. James "Sean" Albright appealed the Approved Facility near 20 Francesca Way in Alamo. The grounds for his appeal seem to encompass the accuracy of the photosimulations and traffic safety. During the Planning Commission hearing, he expressed concern over visibility of a traffic signal in the vicinity.

With respect to traffic safety, the traffic light to which Mr. Albright refers is roughly 500 feet away. We have attached new photosimulations (see Exhibit G) that show the view of a driver pulling out from Francesca Way onto Danville Boulevard. These photos demonstrate that because of the height of the proposed equipment, a driver's view while exiting Francesca Way onto Danville Boulevard will not be obscured nor compromised in any way.

We are unclear what point Mr. Albright is attempting to make with his argument that the pole "has always been there," but he does not provide any substantial evidence that would support denial.

For this Approved Facility, the attached RF report prepared by Hammett & Edison, Inc., Consulting Engineers, demonstrates that the calculated exposure levels are well below the FCC's thresholds. For a person anywhere at ground, the maximum RF exposure level is calculated to be 0.10% of the applicable public exposure limit, and the maximum calculated level at the second-floor elevation of any nearby building is 0.18% of the public exposure limit. These results are conservative, as they include several "worst-case" assumptions. Consequently, they are expected to overstate the emissions.

Verizon Wireless also analyzed two alternative poles on Danville Boulevard – one 135 feet south of the subject pole and one 145 feet north of the subject pole. It also looked at a third pole on 125 feet east from the subject pole on Laurenita Way. All three poles have pole-top fuses or "cut-outs." As previously discussed, PG&E does not allow equipment on poles with these "cut-outs," so these poles are not viable alternatives.

In sum, the Appellants raise no conflict with the Code and provide no substantial evidence for denial. In contrast, Verizon Wireless has provided ample evidence that the Approved Facilities comply with all County requirements. The appeals must be rejected.

## VI. Conclusion

Verizon Wireless has worked diligently to identify the ideal locations and designs for small cell facilities to serve the County. As confirmed by the Zoning Administrator and Planning Commission, the Approved Facilities meet all findings for a wireless access permit and comply with the Code's design criteria for right-of-way facilities. Appellants have raised no substantial evidence to the contrary. Ensuring reliable Verizon Wireless service in the County is critical to residents and visitors as well as emergency service personnel. We strongly encourage you to affirm the Zoning Administrator's and Planning Commission's approvals and deny the appeals.

Very truly yours,



Paul B. Albritton

cc: Stephen Siptroth, Esq.  
Telma Moreira  
Aruna Bhat

**Schedule of Exhibits**

- Exhibit A:** Verizon Wireless Radio Frequency Engineer's Site Justification
- Exhibit B:** Letter From Verizon Wireless Customer Relationship Management re:  
Text Campaign
- Exhibit C:** WA18-0002 (401 Horsetrail Court)
- Exhibit D:** WA18-0004 (1524 Alamo Way)
- Exhibit E:** WA17-0013 (184 Creekdale Road)
- Exhibit F:** WA18-0003 (1955 Meadow Road)
- Exhibit G:** WA17-0008 (20 Francesca Way)
- Exhibit H:** PG&E Installation Details For Service To Pole-Mounted Communication  
Equipment



**Exhibit A**

**VZW 5 Small Cells**

**SF ALAMO 008**

**SF ALAMO 009**

**SF ALAMO 011**

**SF ALAMO 012**

**SF ALAMO 013**

**Site Justification Package**



Confidential and proprietary materials for authorized Verizon personnel and outside agencies only. Use, disclosure or distribution of this material is not permitted to any unauthorized persons or third parties except by written agreement.

## 5 SMALL CELLS in ALAMO CA COVERAGE OBJECTIVES

### **SF ALAMO 008**

This small cell will offload existing gamma sector of ALAMO site. Dominant signal is represented in blue coverage as shown on page 5. It will augment service in adjacent Alamo Plaza and main thorough fare along Danville Blvd and I-680. Subscribers experience performance degradation in these areas during busy hour.

### **SF ALAMO 009**

This small cell will offload ALAMO site. It will also augment quality of service in the surrounding residential neighborhood especially during busy hour. Dominant signal from this cell will help improve data throughput on peak usage at junction of Livorna towards entrance to I-680.

### **SF ALAMO 011**

This small cell is mainly to fill-in existing coverage gap in and around Danville Blvd from Rudgear Rd in the north and Hillgrade Ave in the south. Residential neighborhood with existing minimal to no coverage will have increase service in said areas. Additionally, it will also relieve beta sector of DT WALNUT CREEK site currently congested and serving Danville Blvd from Rudgear Rd junction to its propose location.

### **SF ALAMO 012**

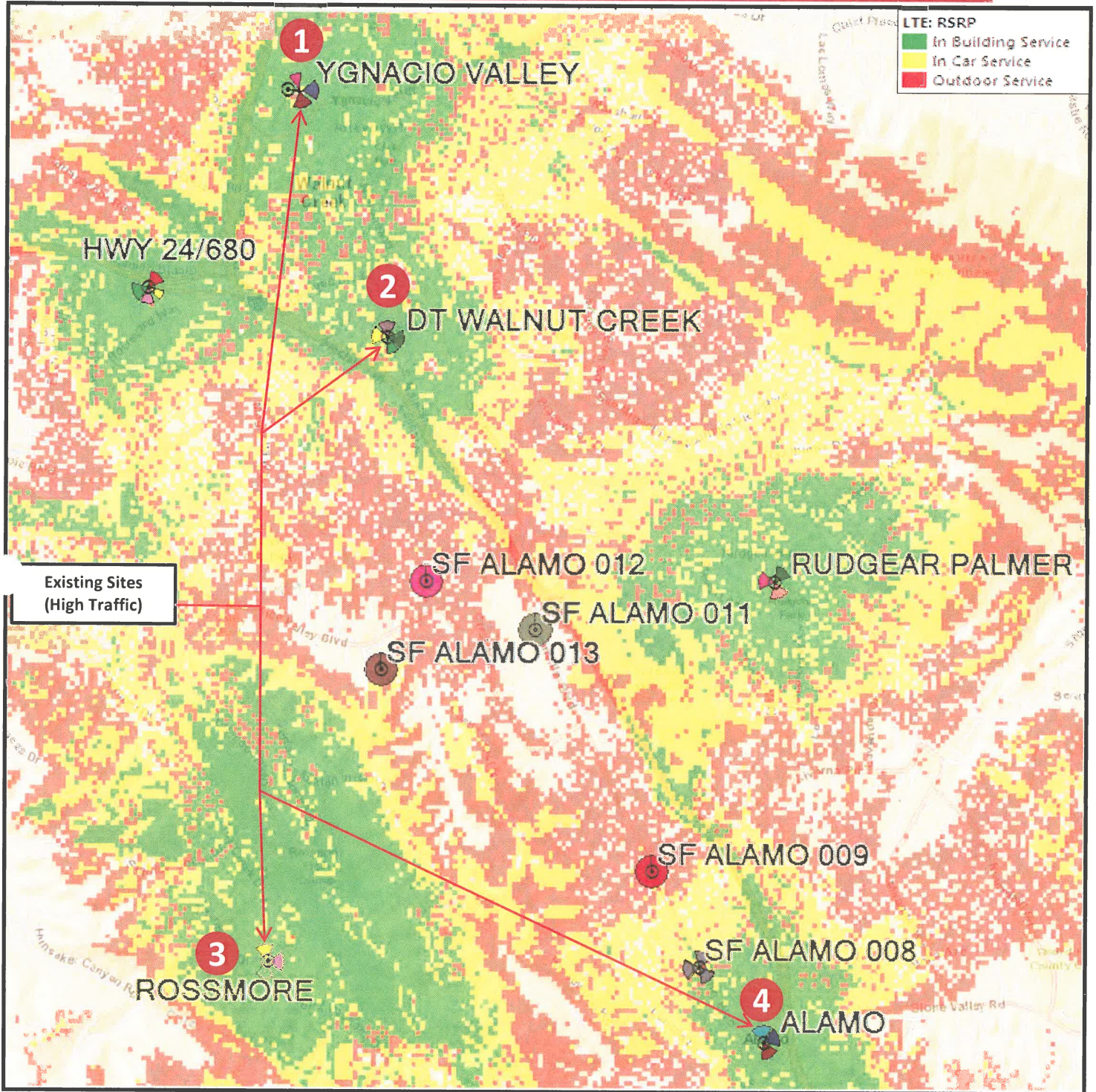
This small cell is primarily to offload beta sectors of DT WALNUT CREEK and YGNACIO VALLEY macro sites. It will provide a significant role to its symbiotic operation of cell network serving high traffic areas in I-80, Walnut Heights area, Corpus Cristi School, and its surrounding neighborhood. Integrating this new cell increases its operating bandwidth providing relief to its existing sites that experience an increase of demand in service during busy hours.

### **SF ALAMO 013**

This small cell is designed to offload existing gamma sector of ROSSMORE as well as beta sectors of YGNACIO VALLEY and DT WALNUT CREEK sites. Expanded footprint along Tice Blvd that has minimal to no coverage will be augmented by this new cell.



# 5 ALAMO SMALL CELLS JUSTIFICATION EXISTING COMPOSITE COVERAGE (On-Air)



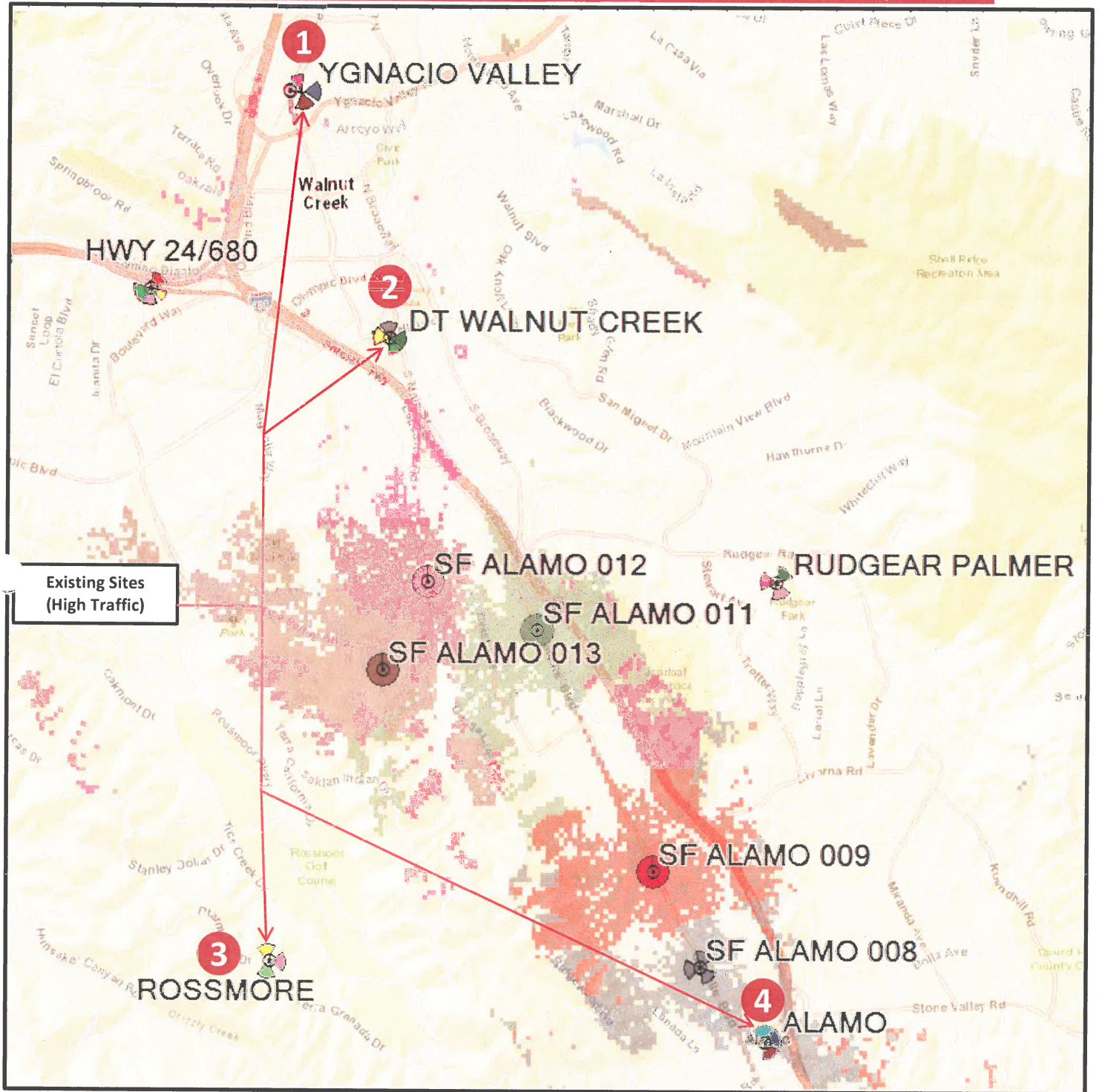
Signal strengths shown in this graphic are Green (-75 dBM), Yellow (-85 dBM) and Red (-95 dBM). The graphic shows service provided by existing adjacent facilities.



Confidential and proprietary materials for authorized Verizon personnel and outside agencies only. Use, disclosure or distribution of this material is not permitted to any unauthorized persons or third parties except by written agreement.

# 5 ALAMO SMALL CELLS JUSTIFICATION

## Propose BEST SERVER COVERAGE (Standalone)

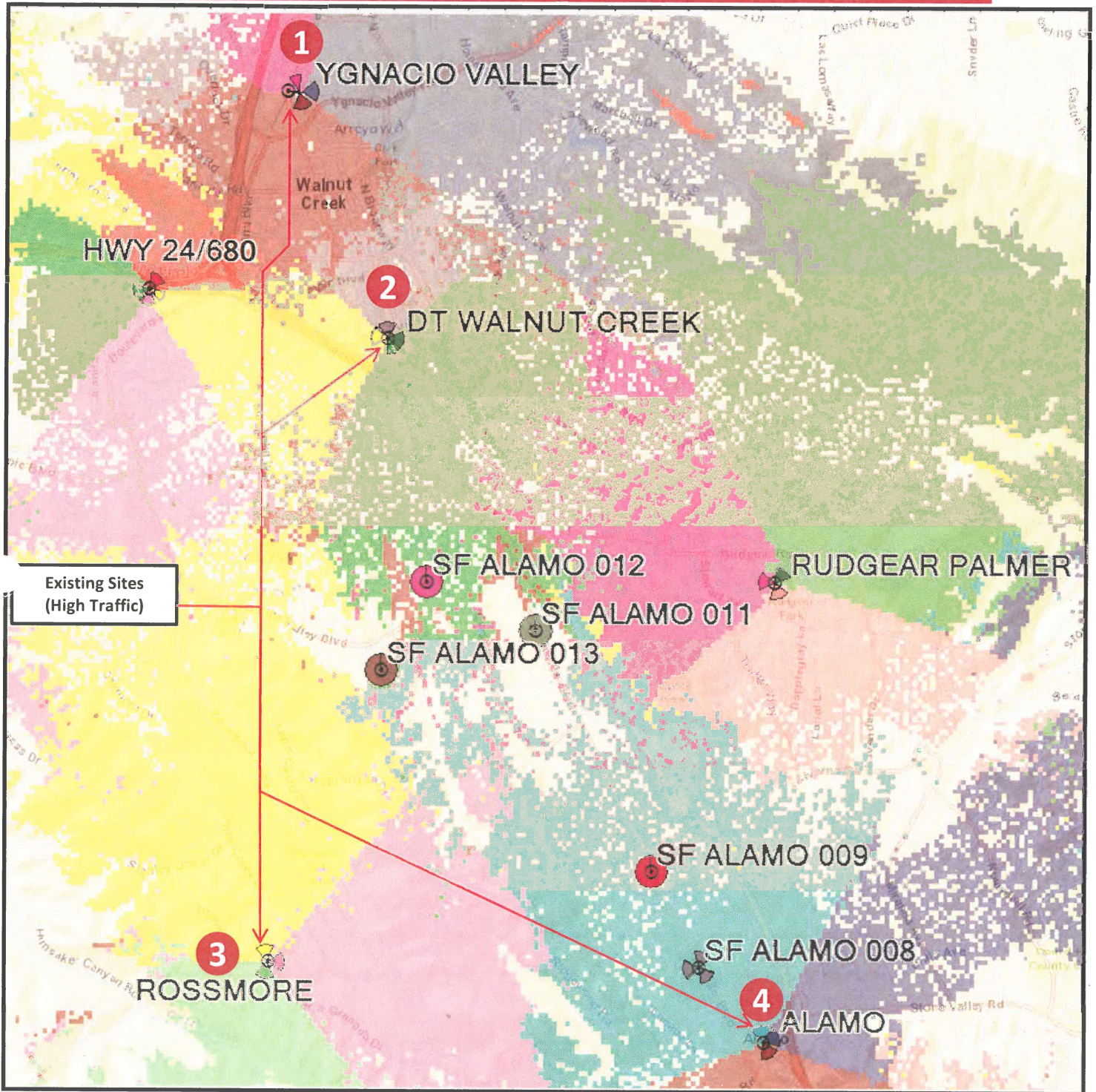


All of the signal strengths shown in this graphic are -95 dBm. Each color in the graphic shows the area of dominant signal at an equal power strength (-95 dBm).



Confidential and proprietary materials for authorized Verizon personnel and outside agencies only. Use, disclosure or distribution of this material is not permitted to any unauthorized persons or third parties except by written agreement.

# 5 ALAMO SMALL CELLS JUSTIFICATION EXISTING BEST SERVER COVERAGE (On-Air)



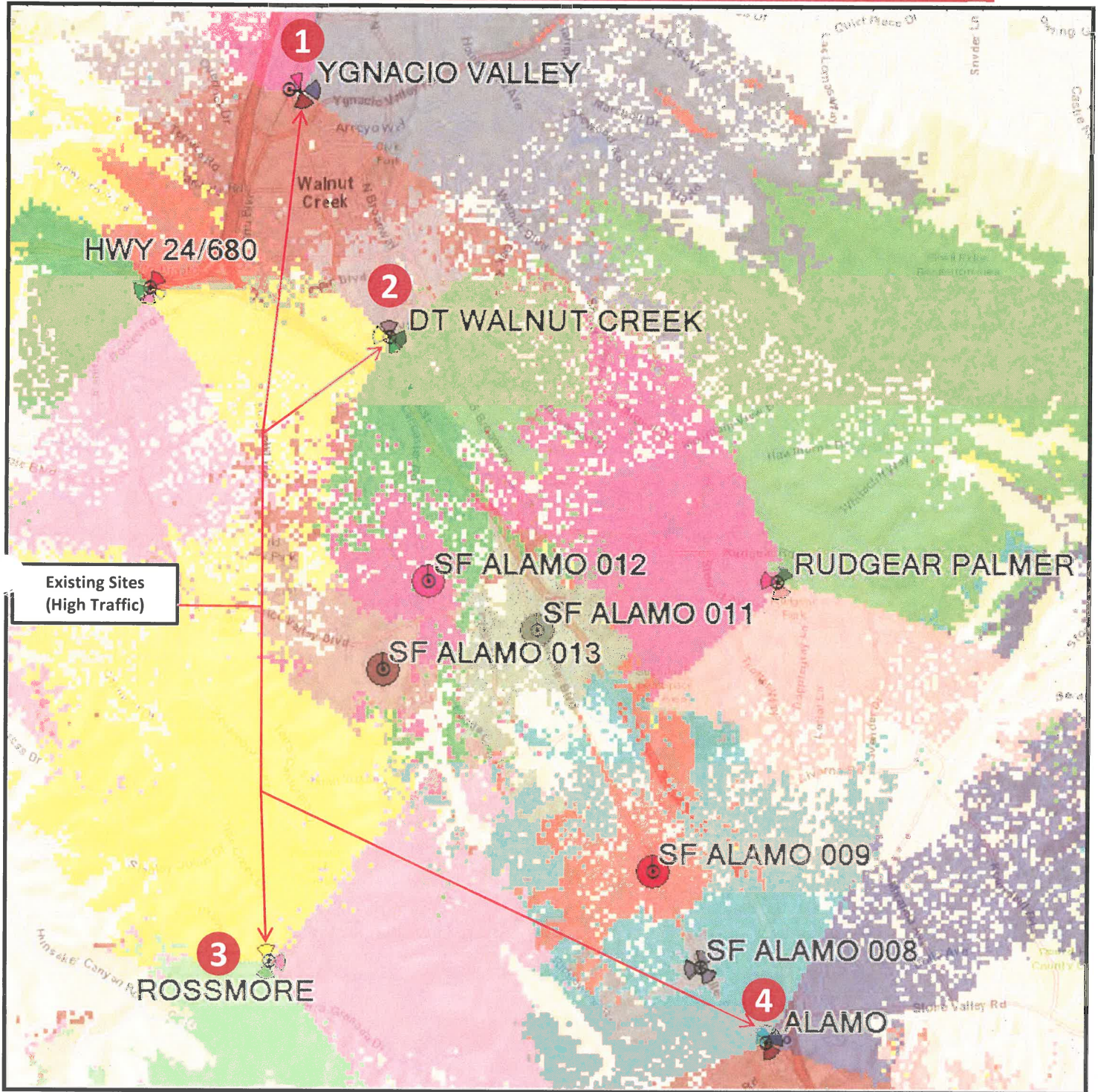
Above, best server map shows GREEN, BROWN, YELLOW-PINK, & BLUE are coverage from DT WALNUT CREEK, YGNACIO VALLEY, ROSSMORE, & ALAMO where SF ALAMO 008, 009, 011, 012, & 013 will cover as new dominant servers. Thus, offloading existing congested sites with new best server coverage shown on next page. All of the signal strengths shown in this graphic are -95 dBm. Each color in the graphic shows the area of dominant signal at an equal power strength (-95 dBm).



Confidential and proprietary materials for authorized Verizon personnel and outside agencies only. Use, disclosure or distribution of this material is not permitted to any unauthorized persons or third parties except by written agreement.

# 5 ALAMO SMALL CELLS JUSTIFICATION

## On-Air + Propose COMPOSITE COVERAGE



See note on previous slide.



Confidential and proprietary materials for authorized Verizon personnel and outside agencies only. Use, disclosure or distribution of this material is not permitted to any unauthorized persons or third parties except by written agreement.

**verizon**<sup>v</sup>

**Verizon Wireless**

15505 Sand Canyon Ave, Bldg. D  
Irvine, CA 92618

March 12, 2018

Planning Commission  
Contra Costa County  
30 Muir Road  
Martinez, California 94553

Re: 255 Supporters for Verizon Wireless Small Cells  
Alamo Area, Contra Costa County

To Whom It May Concern:

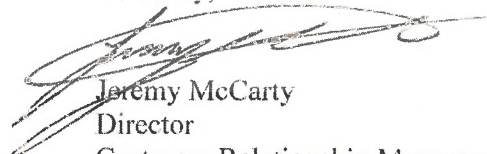
I am the Verizon Wireless Marketing Director over the team that maintains and manages all data and information messages that are sent to Verizon Wireless customers in California. In connection with the application referred to above, Verizon Wireless arranged for a text message to be sent to customers with billing addresses within ZIP codes 94507 and 94595 in the Alamo area of Contra Costa County. The entire text message sent reads as follows:

Free Verizon Message: Reply YES to this text to show your support for improved Verizon Wireless service in Alamo. Add a message to tell the County that you support utility pole mounted small cells on select County streets. Include your email address for updates.

The text message above was sent on March 1, 2018. As of March 6, 2018, we have received 255 affirmative text message responses indicating support for the proposed facilities and 15 respondents opposed. Text messages received confirmed the need to provide improved Verizon Wireless service in the Alamo area. Samples of the text messages of support received from Verizon Wireless customers appear on the attached pages.

I am available to verify the above information as you may require.

Sincerely,



Jeremy McCarty  
Director  
Customer Relationship Management

Attachment

**Sample Text Messages of Support  
Verizon Wireless Small Cells  
Alamo Area, Contra Costa County**

I support it with heart!!! We NEED it!!

Please add more cellular sites in the east side of Alamo.

YES I support utility pole mounted small cells on select County streets! Germain Hauprich

Yes - I always get disconnected when driving in this area and it is very frustrating!

Yes, my wireless is weak at best please allow Verizon to improve service here Stan weissman Alamo

Yes And I agree with small cells

Yes Cells so important for fire and police safety

YES County: please approve efforts by Verizon to get more Verizon small cells on County streets.

Yes for utility pole mounted in Alamo

Yes go for it

Yes I approve wireless service in Alamo.

Yes I support better cell phone service by Verizon!

Yes I support small cells on utility poles in Alamo.

Yes I support small cells on utility poles in this county.

Yes Support utility pole mounted small cells on select County streets.

Yes we need better service

Yes, we support utility pole mounted small cells on select county streets,

Yes, I support this!

Yes, I support utility pole mounted small cells on select streets.



Yes, need more coverage! Thanks

YES, small cells ok,

Yes! By all means! We need them !!!

Yes. I support utility poles mounted on small cells

YES. I support small cell devices anywhere that service is spotty. Why would this even be an issue?

Yes. I support utility pole mounted small cells on county streets

Yes. We need more utility poles in Alamo. We presently cannot use our cell phones

YES. I have a hard time getting phone calls at my house and it is really frustrating. Please add more towers! Make them look like trees if you have to!

Yes. I support pole mounted small cells on County streets.

YES. Service is horrible and we've considered switching carriers just to be able to use our phones in our house

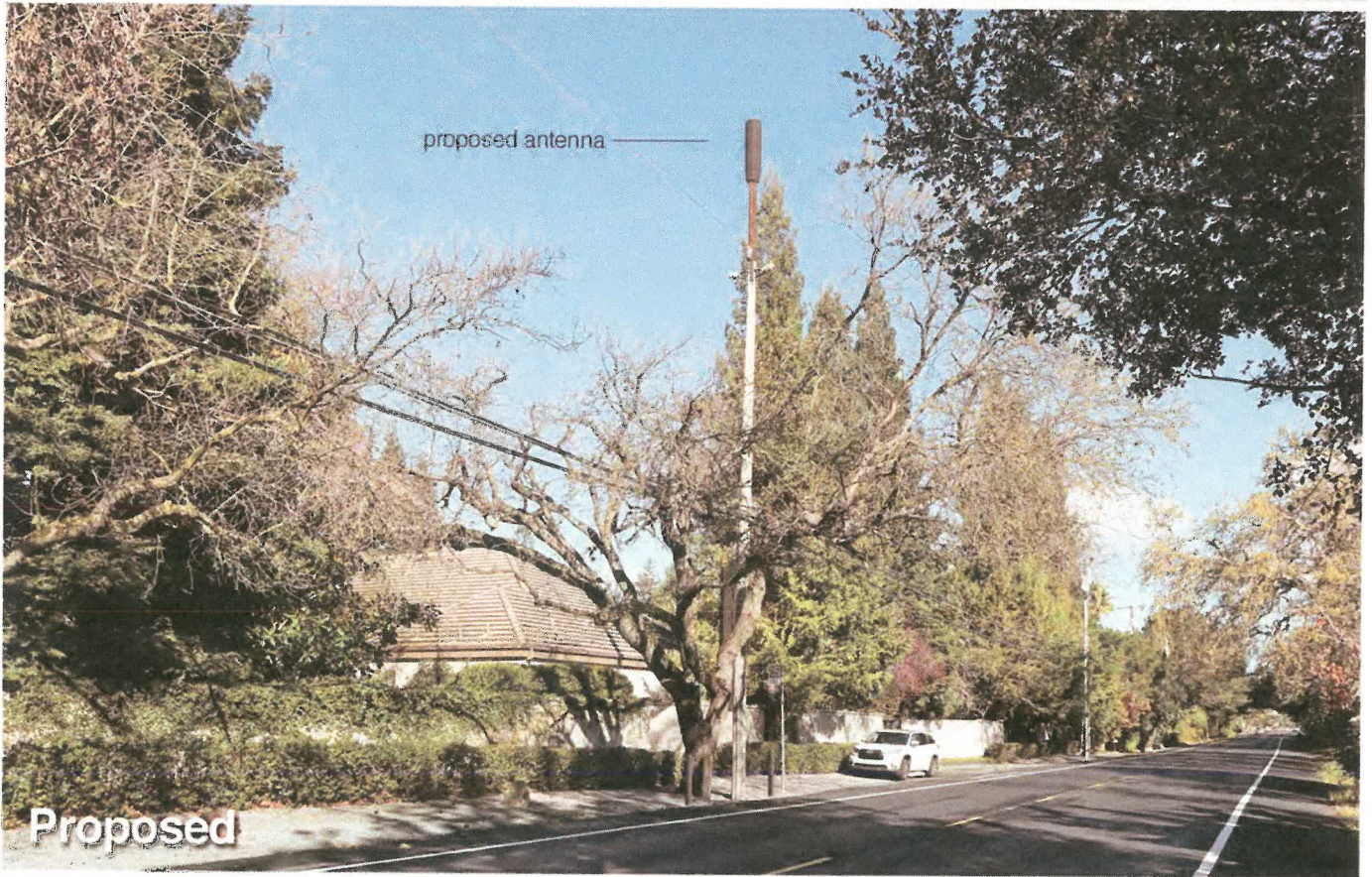
YES. We need better wireless coverage in Alamo.

Yes....I support utility pole mounted small cells

# Exhibit C



Existing



proposed antenna

Proposed



Existing



proposed antenna

Proposed



SF Alamo Site # 011

Looking South from Danville Blvd.

8/15/18

(near) 401 Horsetrail Ct.  
Alamo, CA

View #2

Applied Imagination 510 914-0500

**Verizon Wireless • Proposed Small Cell (No. 433677 “SF Alamo 011”)  
Near 401 Horsetrail Court • Alamo, California**

**Statement of Hammett & Edison, Inc., Consulting Engineers**

The firm of Hammett & Edison, Inc., Consulting Engineers, has been retained on behalf of Verizon Wireless, a personal wireless telecommunications carrier, to evaluate its small cell (No. 433677 “SF Alamo 011”) proposed to be sited in Alamo, California, for compliance with appropriate guidelines limiting human exposure to radio frequency (“RF”) electromagnetic fields.

**Executive Summary**

Verizon proposes to install a cylindrical antenna on the utility pole sited in the public right-of-way near 401 Horsetrail Court in Alamo. The proposed operation will comply with the FCC guidelines limiting public exposure to RF energy.

**Prevailing Exposure Standard**

The U.S. Congress requires that the Federal Communications Commission (“FCC”) evaluate its actions for possible significant impact on the environment. A summary of the FCC’s human exposure limits is shown in Figure 1. These limits apply for continuous exposures and are intended to provide a prudent margin of safety for all persons, regardless of age, gender, size, or health. The FCC limit for exposures of unlimited duration to radio frequency energy for various wireless services are as follows:

Wireless Service	Frequency Band	Occupational Limit	Public Limit
Microwave (Point-to-Point)	5–80 GHz	5.00 mW/cm <sup>2</sup>	1.00 mW/cm <sup>2</sup>
WiFi (and unlicensed uses)	2–6	5.00	1.00
BRS (Broadband Radio)	2,600 MHz	5.00	1.00
WCS (Wireless Communication)	2,300	5.00	1.00
AWS (Advanced Wireless)	2,100	5.00	1.00
PCS (Personal Communication)	1,950	5.00	1.00
Cellular	870	2.90	0.58
SMR (Specialized Mobile Radio)	855	2.85	0.57
700 MHz	700	2.40	0.48
[most restrictive frequency range]	30–300	1.00	0.20

Power line frequencies (60 Hz) are well below the applicable range of this standard, and there is considered to be no compounding effect from simultaneous exposure to power line and radio frequency fields.

**General Facility Requirements**

Small cells typically consist of two distinct parts: the electronic transceivers (also called “radios”) that are connected to the traditional wired telephone lines, and the passive antennas that send the wireless signals created by the radios out to be received by individual subscriber units. The transceivers are

**Verizon Wireless • Proposed Small Cell (No. 433677 “SF Alamo 011”)  
Near 401 Horsetrail Court • Alamo, California**

typically mounted on the support pole or placed in a cabinet at ground level. Because of the short wavelength of the frequencies assigned by the FCC for wireless services, the antennas require line-of-sight paths for their signals to propagate well and so are installed at some height above ground. The antennas are designed to concentrate their energy toward the horizon, with very little energy wasted toward the sky or the ground. This means that it is generally not possible for exposure conditions to approach the maximum permissible exposure limits without being physically in front of the antennas.

**Computer Modeling Method**

The FCC provides direction for determining compliance in its Office of Engineering and Technology Bulletin No. 65, “Evaluating Compliance with FCC-Specified Guidelines for Human Exposure to Radio Frequency Radiation,” dated August 1997. Figure 2 describes the calculation methodologies, reflecting the facts that a directional antenna’s radiation pattern is not fully formed at locations very close by (the “near-field” effect) and that at greater distances the power level from an energy source decreases with the square of the distance from it (the “inverse square law”). The conservative nature of this method for evaluating exposure conditions has been verified by numerous field tests.

**Site and Facility Description**

Based upon information provided by Verizon, including drawings by Meridian Management, Inc., dated April 3, 2018, it is proposed to install one Amphenol Model CUUT360X12F, 4-foot tall omnidirectional antenna on an extension above the top of the utility pole sited in the public right-of-way on the southwest side of Danville Boulevard, about 100 feet southeast of Horsetrail Court in Alamo. The antenna would employ no downtilt and would be mounted at an effective height of about 49½ feet above ground. The maximum effective radiated power in any direction would be 1,580 watts, representing simultaneous operation at 840 watts for AWS and 740 watts for PCS service. There are reported no other wireless telecommunications base stations at this site or nearby.

**Study Results**

For a person anywhere at ground, the maximum RF exposure level due to the proposed Verizon operation is calculated to be 0.0012 mW/cm<sup>2</sup>, which is 0.12% of the applicable public exposure limit. The maximum calculated level at the second-floor elevation of any nearby building is 0.14% of the public exposure limit. It should be noted that these results include several “worst-case” assumptions and therefore are expected to overstate actual power density levels from the proposed operation.

**Recommended Mitigation Measures**

Due to its mounting location and height, the Verizon antenna would not be accessible to unauthorized persons, and so no mitigation measures are necessary to comply with the FCC public exposure

**Verizon Wireless • Proposed Small Cell (No. 433677 “SF Alamo 011”)  
Near 401 Horsetrail Court • Alamo, California**

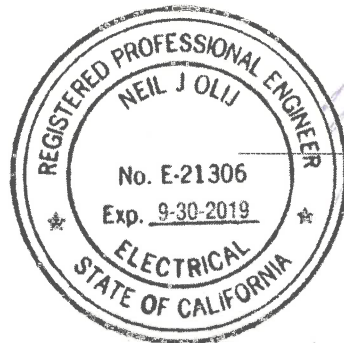
guidelines. To prevent occupational exposures in excess of the FCC guidelines, it is recommended that appropriate RF safety training, to include review of personal monitor use, be provided to all authorized personnel who have access to the antenna. No access within 3 feet at the same height as the antenna, such as might occur during certain maintenance activities at the top of the pole, should be allowed while the small cell is in operation, unless other measures can be demonstrated to ensure that occupational protection requirements are met. It is recommended that an explanatory sign\* be posted at the antenna and/or on the pole below the antenna, readily visible to persons who might need to work within that distance.

**Conclusion**

Based on the information and analysis above, it is the undersigned’s professional opinion that operation of the small cell proposed by Verizon Wireless near 401 Horsetrail Court in Alamo, California, will comply with the prevailing standards for limiting public exposure to radio frequency energy and, therefore, will not for this reason cause a significant impact on the environment. The highest calculated level in publicly accessible areas is much less than the prevailing standards allow for exposures of unlimited duration. This finding is consistent with measurements of actual exposure conditions taken at other operating small cells. Training authorized personnel and posting explanatory signs are recommended to establish compliance with occupational exposure limits.

**Authorship**

The undersigned author of this statement is a qualified Professional Engineer, holding California Registration No. E-21306, which expires on September 30, 2019. This work has been carried out under his direction, and all statements are true and correct of his own knowledge except, where noted, when data has been supplied by others, which data he believes to be correct.



Neil J. Olij, P.E.  
707/996-5200

April 13, 2018

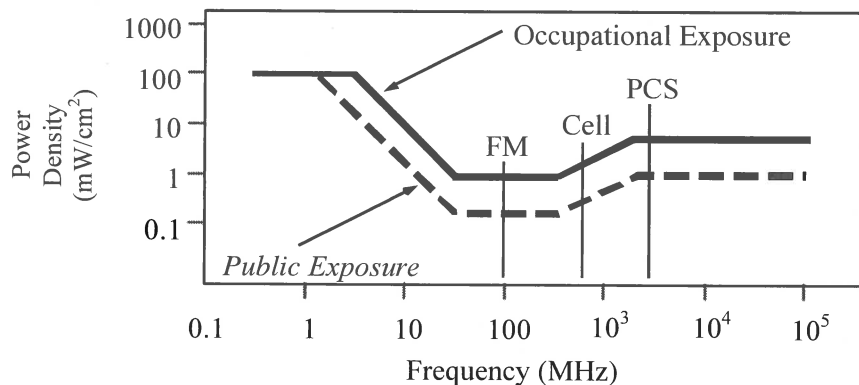
\* Signs should comply with OET-65 color, symbol, and content recommendations. Contact information should be provided (e.g., a telephone number) to arrange for access to restricted areas. The selection of language(s) is not an engineering matter, and guidance from the landlord, local zoning or health authority, or appropriate professionals may be required. Signage may also need to comply with the requirements of California Public Utilities Commission General Order No. 95.

## FCC Radio Frequency Protection Guide

The U.S. Congress required (1996 Telecom Act) the Federal Communications Commission (“FCC”) to adopt a nationwide human exposure standard to ensure that its licensees do not, cumulatively, have a significant impact on the environment. The FCC adopted the limits from Report No. 86, “Biological Effects and Exposure Criteria for Radiofrequency Electromagnetic Fields,” published in 1986 by the Congressionally chartered National Council on Radiation Protection and Measurements (“NCRP”). Separate limits apply for occupational and public exposure conditions, with the latter limits generally five times more restrictive. The more recent standard, developed by the Institute of Electrical and Electronics Engineers and approved as American National Standard ANSI/IEEE C95.1-2006, “Safety Levels with Respect to Human Exposure to Radio Frequency Electromagnetic Fields, 3 kHz to 300 GHz,” includes similar limits. These limits apply for continuous exposures from all sources and are intended to provide a prudent margin of safety for all persons, regardless of age, gender, size, or health.

As shown in the table and chart below, separate limits apply for occupational and public exposure conditions, with the latter limits (in *italics* and/or dashed) up to five times more restrictive:

Frequency Applicable Range (MHz)	Electromagnetic Fields (f is frequency of emission in MHz)					
	Electric Field Strength (V/m)		Magnetic Field Strength (A/m)		Equivalent Far-Field Power Density (mW/cm <sup>2</sup> )	
0.3 – 1.34	614	<i>614</i>	1.63	<i>1.63</i>	100	<i>100</i>
1.34 – 3.0	614	<i>823.8/f</i>	1.63	<i>2.19/f</i>	100	<i>180/f<sup>2</sup></i>
3.0 – 30	1842/f	<i>823.8/f</i>	4.89/f	<i>2.19/f</i>	900/f <sup>2</sup>	<i>180/f<sup>2</sup></i>
30 – 300	61.4	<i>27.5</i>	0.163	<i>0.0729</i>	1.0	<i>0.2</i>
300 – 1,500	3.54√f	<i>1.59√f</i>	√f/106	<i>√f/238</i>	f/300	<i>f/1500</i>
1,500 – 100,000	137	<i>61.4</i>	0.364	<i>0.163</i>	5.0	<i>1.0</i>



Higher levels are allowed for short periods of time, such that total exposure levels averaged over six or thirty minutes, for occupational or public settings, respectively, do not exceed the limits, and higher levels also are allowed for exposures to small areas, such that the spatially averaged levels do not exceed the limits. However, neither of these allowances is incorporated in the conservative calculation formulas in the FCC Office of Engineering and Technology Bulletin No. 65 (August 1997) for projecting field levels. Hammett & Edison has built those formulas into a proprietary program that calculates, at each location on an arbitrary rectangular grid, the total expected power density from any number of individual radio sources. The program allows for the description of buildings and uneven terrain, if required to obtain more accurate projections.

## RFR.CALC™ Calculation Methodology

### Assessment by Calculation of Compliance with FCC Exposure Guidelines

The U.S. Congress required (1996 Telecom Act) the Federal Communications Commission (“FCC”) to adopt a nationwide human exposure standard to ensure that its licensees do not, cumulatively, have a significant impact on the environment. The maximum permissible exposure limits adopted by the FCC (see Figure 1) apply for continuous exposures from all sources and are intended to provide a prudent margin of safety for all persons, regardless of age, gender, size, or health. Higher levels are allowed for short periods of time, such that total exposure levels averaged over six or thirty minutes, for occupational or public settings, respectively, do not exceed the limits.

#### Near Field.

Prediction methods have been developed for the near field zone of panel (directional) and whip (omnidirectional) antennas, typical at wireless telecommunications base stations, as well as dish (aperture) antennas, typically used for microwave links. The antenna patterns are not fully formed in the near field at these antennas, and the FCC Office of Engineering and Technology Bulletin No. 65 (August 1997) gives suitable formulas for calculating power density within such zones.

For a panel or whip antenna, power density  $S = \frac{180}{\theta_{BW}} \times \frac{0.1 \times P_{net}}{\pi \times D \times h}$ , in mW/cm<sup>2</sup>,

and for an aperture antenna, maximum power density  $S_{max} = \frac{0.1 \times 16 \times \eta \times P_{net}}{\pi \times h^2}$ , in mW/cm<sup>2</sup>,

where  $\theta_{BW}$  = half-power beamwidth of the antenna, in degrees, and

$P_{net}$  = net power input to the antenna, in watts,

$D$  = distance from antenna, in meters,

$h$  = aperture height of the antenna, in meters, and

$\eta$  = aperture efficiency (unitless, typically 0.5-0.8).

The factor of 0.1 in the numerators converts to the desired units of power density.

#### Far Field.

OET-65 gives this formula for calculating power density in the far field of an individual RF source:

power density  $S = \frac{2.56 \times 1.64 \times 100 \times RFF^2 \times ERP}{4 \times \pi \times D^2}$ , in mW/cm<sup>2</sup>,

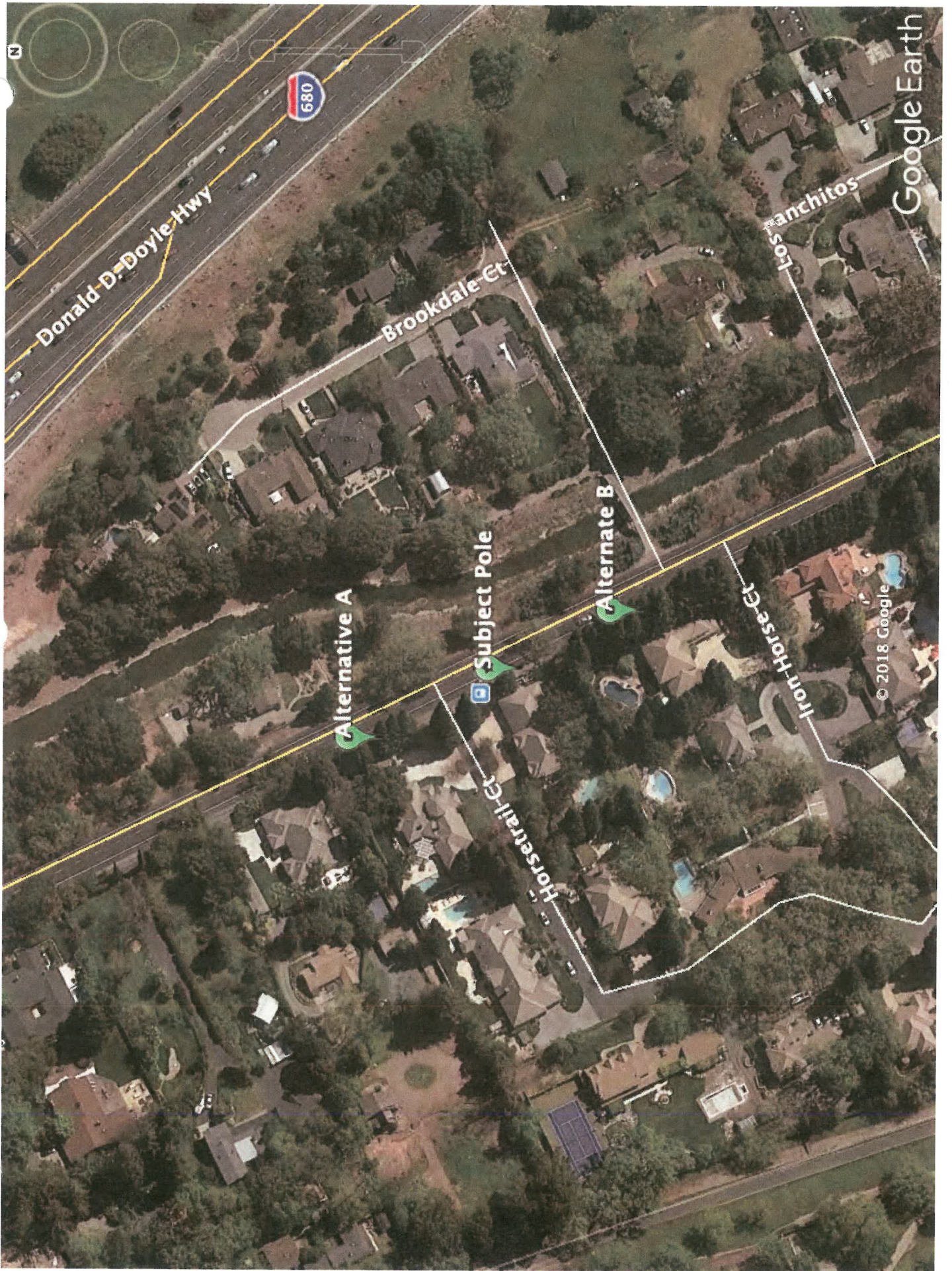
where ERP = total ERP (all polarizations), in kilowatts,

RFF = relative field factor at the direction to the actual point of calculation, and

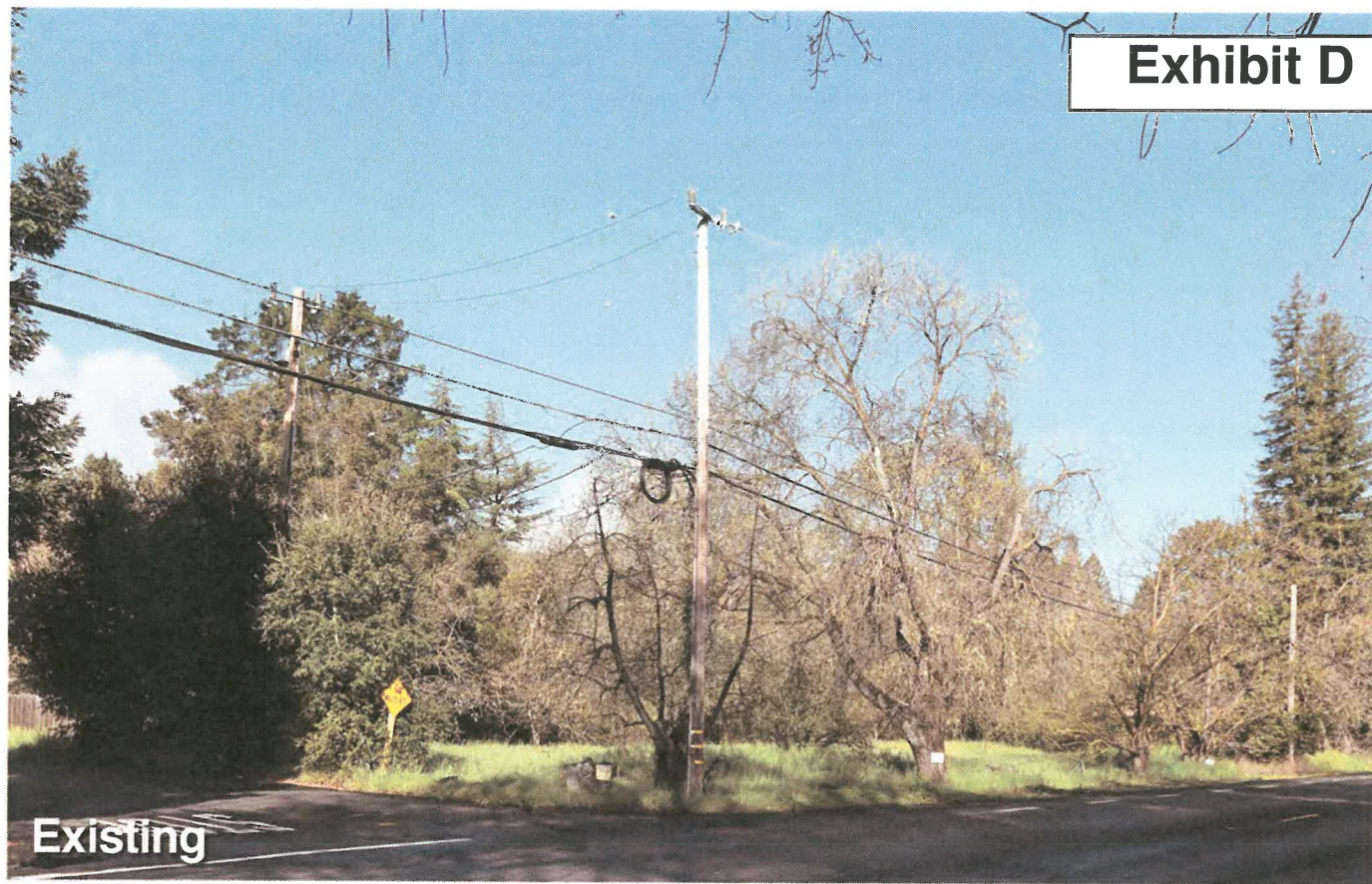
$D$  = distance from the center of radiation to the point of calculation, in meters.

The factor of 2.56 accounts for the increase in power density due to ground reflection, assuming a reflection coefficient of 1.6 (1.6 x 1.6 = 2.56). The factor of 1.64 is the gain of a half-wave dipole relative to an isotropic radiator. The factor of 100 in the numerator converts to the desired units of power density. This formula has been built into a proprietary program that calculates, at each location on an arbitrary rectangular grid, the total expected power density from any number of individual radiation sources. The program also allows for the description of uneven terrain in the vicinity, to obtain more accurate projections.





**Exhibit D**





Existing



Proposed

**Verizon Wireless • Proposed Small Cell (No. 433674 “SF Alamo 008”)  
1524 Alamo Way • Alamo, California**

**Statement of Hammett & Edison, Inc., Consulting Engineers**

The firm of Hammett & Edison, Inc., Consulting Engineers, has been retained on behalf of Verizon Wireless, a personal wireless telecommunications carrier, to evaluate its small cell (No. 433674 “SF Alamo 0008”) proposed to be sited in Alamo, California, for compliance with appropriate guidelines limiting human exposure to radio frequency (“RF”) electromagnetic fields.

**Executive Summary**

Verizon proposes to install a cylindrical antenna on a utility pole to be sited in the public right-of-way near 1524 Alamo Way in Alamo. The proposed operation will comply with the FCC guidelines limiting public exposure to RF energy.

**Prevailing Exposure Standard**

The U.S. Congress requires that the Federal Communications Commission (“FCC”) evaluate its actions for possible significant impact on the environment. A summary of the FCC’s human exposure limits is shown in Figure 1. These limits apply for continuous exposures and are intended to provide a prudent margin of safety for all persons, regardless of age, gender, size, or health. The FCC limit for exposures of unlimited duration to radio frequency energy for various wireless services are as follows:

Wireless Service	Frequency Band	Occupational Limit	Public Limit
Microwave (Point-to-Point)	5–80 GHz	5.00 mW/cm <sup>2</sup>	1.00 mW/cm <sup>2</sup>
WiFi (and unlicensed uses)	2–6	5.00	1.00
BRS (Broadband Radio)	2,600 MHz	5.00	1.00
WCS (Wireless Communication)	2,300	5.00	1.00
AWS (Advanced Wireless)	2,100	5.00	1.00
PCS (Personal Communication)	1,950	5.00	1.00
Cellular	870	2.90	0.58
SMR (Specialized Mobile Radio)	855	2.85	0.57
700 MHz	700	2.40	0.48
[most restrictive frequency range]	30–300	1.00	0.20

Power line frequencies (60 Hz) are well below the applicable range of this standard, and there is considered to be no compounding effect from simultaneous exposure to power line and radio frequency fields.

**General Facility Requirements**

Small cells typically consist of two distinct parts: the electronic transceivers (also called “radios”) that are connected to the traditional wired telephone lines, and the passive antennas that send the wireless signals created by the radios out to be received by individual subscriber units. The transceivers are typically mounted on the support pole or placed in a cabinet at ground level, and they are connected to

**Verizon Wireless • Proposed Small Cell (No. 433674 “SF Alamo 008”)  
1524 Alamo Way • Alamo, California**

the antennas by coaxial cables. Because of the short wavelength of the frequencies assigned by the FCC for wireless services, the antennas require line-of-sight paths for their signals to propagate well and so are installed at some height above ground. The antennas are designed to concentrate their energy toward the horizon, with very little energy wasted toward the sky or the ground. This means that it is generally not possible for exposure conditions to approach the maximum permissible exposure limits without being physically very near the antennas.

**Computer Modeling Method**

The FCC provides direction for determining compliance in its Office of Engineering and Technology Bulletin No. 65, “Evaluating Compliance with FCC-Specified Guidelines for Human Exposure to Radio Frequency Radiation,” dated August 1997. Figure 2 describes the calculation methodologies, reflecting the facts that a directional antenna’s radiation pattern is not fully formed at locations very close by (the “near-field” effect) and that at greater distances the power level from an energy source decreases with the square of the distance from it (the “inverse square law”). The conservative nature of this method for evaluating exposure conditions has been verified by numerous field tests.

**Site and Facility Description**

Based upon information provided by Verizon, including drawings by Meridian Management, Inc., dated April 3, 2018, it is proposed to install one Amphenol Model CUUT070X06F 2-foot tall, tri-directional cylindrical antenna, with three directions activated, on top of a new utility pole, to replace the existing utility pole sited in the public right-of-way at the northwest corner of Alamo Way and Danville Boulevard in Alamo. The antenna would employ no downtilt, would be mounted at an effective height of about 47½ feet above ground, and would have its principal directions oriented toward 20°T, 140°T, and 260°T. The maximum effective radiated power in any direction would be 1,200 watts, representing simultaneous operation at 630 watts for AWS and 570 watts for PCS service. There are reported no other wireless base stations at the site or nearby.

**Study Results**

For a person anywhere at ground, the maximum RF exposure level due to the proposed Verizon operation is calculated to be 0.0056 mW/cm<sup>2</sup>, which is 0.56% of the applicable public exposure limit. The maximum calculated level at the second-floor elevation of any nearby building, located at least 80 feet away, is 0.94% of the public exposure limit. It should be noted that these results include several “worst-case” assumptions and therefore are expected to overstate actual power density levels from the proposed operation.

**Verizon Wireless • Proposed Small Cell (No. 433674 “SF Alamo 008”)  
1524 Alamo Way • Alamo, California**

**Recommended Mitigation Measures**

Due to its mounting location and height, the Verizon antenna would not be accessible to unauthorized persons, and so no mitigation measures are necessary to comply with the FCC public exposure guidelines. To prevent occupational exposures in excess of the FCC guidelines, it is recommended that appropriate RF safety training, to include review of personal monitor use, be provided to all authorized personnel who have access to the antenna. No access within 8 feet at the same height as the antenna, such as might occur during certain maintenance activities at the top of the pole, should be allowed while the small cell is in operation, unless other measures can be demonstrated to ensure that occupational protection requirements are met. It is recommended that an explanatory sign\* be posted at the antenna and/or on the pole below the antenna, readily visible from any angle of approach to persons who might need to work within that distance.

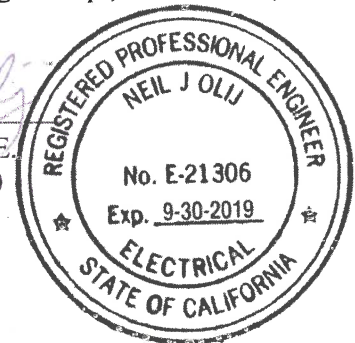
**Conclusion**

Based on the information and analysis above, it is the undersigned’s professional opinion that operation of the small cell proposed by Verizon Wireless near 1524 Alamo Way in Alamo, California, will comply with the prevailing standards for limiting public exposure to radio frequency energy and, therefore, will not for this reason cause a significant impact on the environment. The highest calculated level in publicly accessible areas is much less than the prevailing standards allow for exposures of unlimited duration. This finding is consistent with measurements of actual exposure conditions taken at other operating small cells. Training authorized personnel and posting explanatory signs are recommended to establish compliance with occupational exposure limits.

**Authorship**

The undersigned author of this statement is a qualified Professional Engineer, holding California Registration No. E-21306, which expires on September 30, 2019. This work has been carried out under his direction, and all statements are true and correct of his own knowledge except, where noted, when data has been supplied by others, which data he believes to be correct.

*Neil J. Olij*  
Neil J. Olij, P.E.  
707/996-5200



April 13, 2018

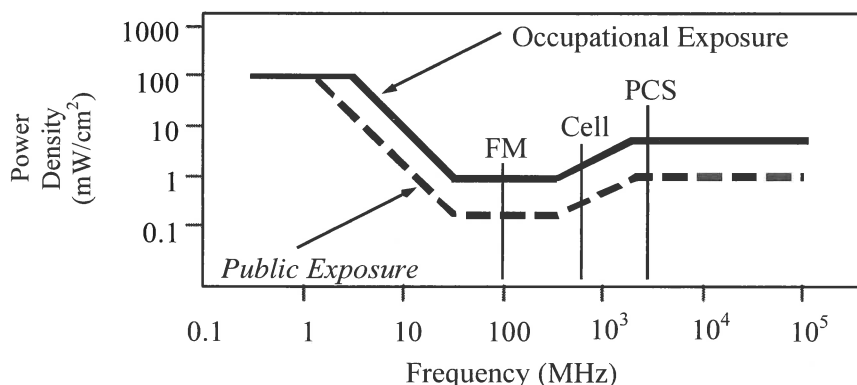
\* Signs should comply with OET-65 color, symbol, and content recommendations. Contact information should be provided (e.g., a telephone number) to arrange for access to restricted areas. The selection of language(s) is not an engineering matter, and guidance from the landlord, local zoning or health authority, or appropriate professionals may be required. Signage may also need to comply with the requirements of California Public Utilities Commission General Order No. 95.

## FCC Radio Frequency Protection Guide

The U.S. Congress required (1996 Telecom Act) the Federal Communications Commission (“FCC”) to adopt a nationwide human exposure standard to ensure that its licensees do not, cumulatively, have a significant impact on the environment. The FCC adopted the limits from Report No. 86, “Biological Effects and Exposure Criteria for Radiofrequency Electromagnetic Fields,” published in 1986 by the Congressionally chartered National Council on Radiation Protection and Measurements (“NCRP”). Separate limits apply for occupational and public exposure conditions, with the latter limits generally five times more restrictive. The more recent standard, developed by the Institute of Electrical and Electronics Engineers and approved as American National Standard ANSI/IEEE C95.1-2006, “Safety Levels with Respect to Human Exposure to Radio Frequency Electromagnetic Fields, 3 kHz to 300 GHz,” includes similar limits. These limits apply for continuous exposures from all sources and are intended to provide a prudent margin of safety for all persons, regardless of age, gender, size, or health.

As shown in the table and chart below, separate limits apply for occupational and public exposure conditions, with the latter limits (in *italics* and/or dashed) up to five times more restrictive:

Frequency Applicable Range (MHz)	Electromagnetic Fields ( <i>f</i> is frequency of emission in MHz)					
	Electric Field Strength (V/m)		Magnetic Field Strength (A/m)		Equivalent Far-Field Power Density (mW/cm <sup>2</sup> )	
0.3 – 1.34	614	<i>614</i>	1.63	<i>1.63</i>	100	<i>100</i>
1.34 – 3.0	614	<i>823.8/f</i>	1.63	<i>2.19/f</i>	100	<i>180/f<sup>2</sup></i>
3.0 – 30	1842/f	<i>823.8/f</i>	4.89/f	<i>2.19/f</i>	900/f <sup>2</sup>	<i>180/f<sup>2</sup></i>
30 – 300	61.4	<i>27.5</i>	0.163	<i>0.0729</i>	1.0	<i>0.2</i>
300 – 1,500	3.54√ <i>f</i>	<i>1.59√f</i>	√ <i>f</i> /106	<i>√f/238</i>	<i>f/300</i>	<i>f/1500</i>
1,500 – 100,000	137	<i>61.4</i>	0.364	<i>0.163</i>	5.0	<i>1.0</i>



Higher levels are allowed for short periods of time, such that total exposure levels averaged over six or thirty minutes, for occupational or public settings, respectively, do not exceed the limits, and higher levels also are allowed for exposures to small areas, such that the spatially averaged levels do not exceed the limits. However, neither of these allowances is incorporated in the conservative calculation formulas in the FCC Office of Engineering and Technology Bulletin No. 65 (August 1997) for projecting field levels. Hammett & Edison has built those formulas into a proprietary program that calculates, at each location on an arbitrary rectangular grid, the total expected power density from any number of individual radio sources. The program allows for the description of buildings and uneven terrain, if required to obtain more accurate projections.

## RFR.CALC™ Calculation Methodology

### Assessment by Calculation of Compliance with FCC Exposure Guidelines

The U.S. Congress required (1996 Telecom Act) the Federal Communications Commission (“FCC”) to adopt a nationwide human exposure standard to ensure that its licensees do not, cumulatively, have a significant impact on the environment. The maximum permissible exposure limits adopted by the FCC (see Figure 1) apply for continuous exposures from all sources and are intended to provide a prudent margin of safety for all persons, regardless of age, gender, size, or health. Higher levels are allowed for short periods of time, such that total exposure levels averaged over six or thirty minutes, for occupational or public settings, respectively, do not exceed the limits.

#### Near Field.

Prediction methods have been developed for the near field zone of panel (directional) and whip (omnidirectional) antennas, typical at wireless telecommunications base stations, as well as dish (aperture) antennas, typically used for microwave links. The antenna patterns are not fully formed in the near field at these antennas, and the FCC Office of Engineering and Technology Bulletin No. 65 (August 1997) gives suitable formulas for calculating power density within such zones.

For a panel or whip antenna, power density  $S = \frac{180}{\theta_{BW}} \times \frac{0.1 \times P_{net}}{\pi \times D \times h}$ , in mW/cm<sup>2</sup>,

and for an aperture antenna, maximum power density  $S_{max} = \frac{0.1 \times 16 \times \eta \times P_{net}}{\pi \times h^2}$ , in mW/cm<sup>2</sup>,

where  $\theta_{BW}$  = half-power beamwidth of the antenna, in degrees, and

$P_{net}$  = net power input to the antenna, in watts,

$D$  = distance from antenna, in meters,

$h$  = aperture height of the antenna, in meters, and

$\eta$  = aperture efficiency (unitless, typically 0.5-0.8).

The factor of 0.1 in the numerators converts to the desired units of power density.

#### Far Field.

OET-65 gives this formula for calculating power density in the far field of an individual RF source:

power density  $S = \frac{2.56 \times 1.64 \times 100 \times RFF^2 \times ERP}{4 \times \pi \times D^2}$ , in mW/cm<sup>2</sup>,

where ERP = total ERP (all polarizations), in kilowatts,

RFF = relative field factor at the direction to the actual point of calculation, and

$D$  = distance from the center of radiation to the point of calculation, in meters.

The factor of 2.56 accounts for the increase in power density due to ground reflection, assuming a reflection coefficient of 1.6 (1.6 x 1.6 = 2.56). The factor of 1.64 is the gain of a half-wave dipole relative to an isotropic radiator. The factor of 100 in the numerator converts to the desired units of power density. This formula has been built into a proprietary program that calculates, at each location on an arbitrary rectangular grid, the total expected power density from any number of individual radiation sources. The program also allows for the description of uneven terrain in the vicinity, to obtain more accurate projections.





Google Earth

© 2018 Google

Alternate B

Subject Pole

Alternate A

Via Don Jose

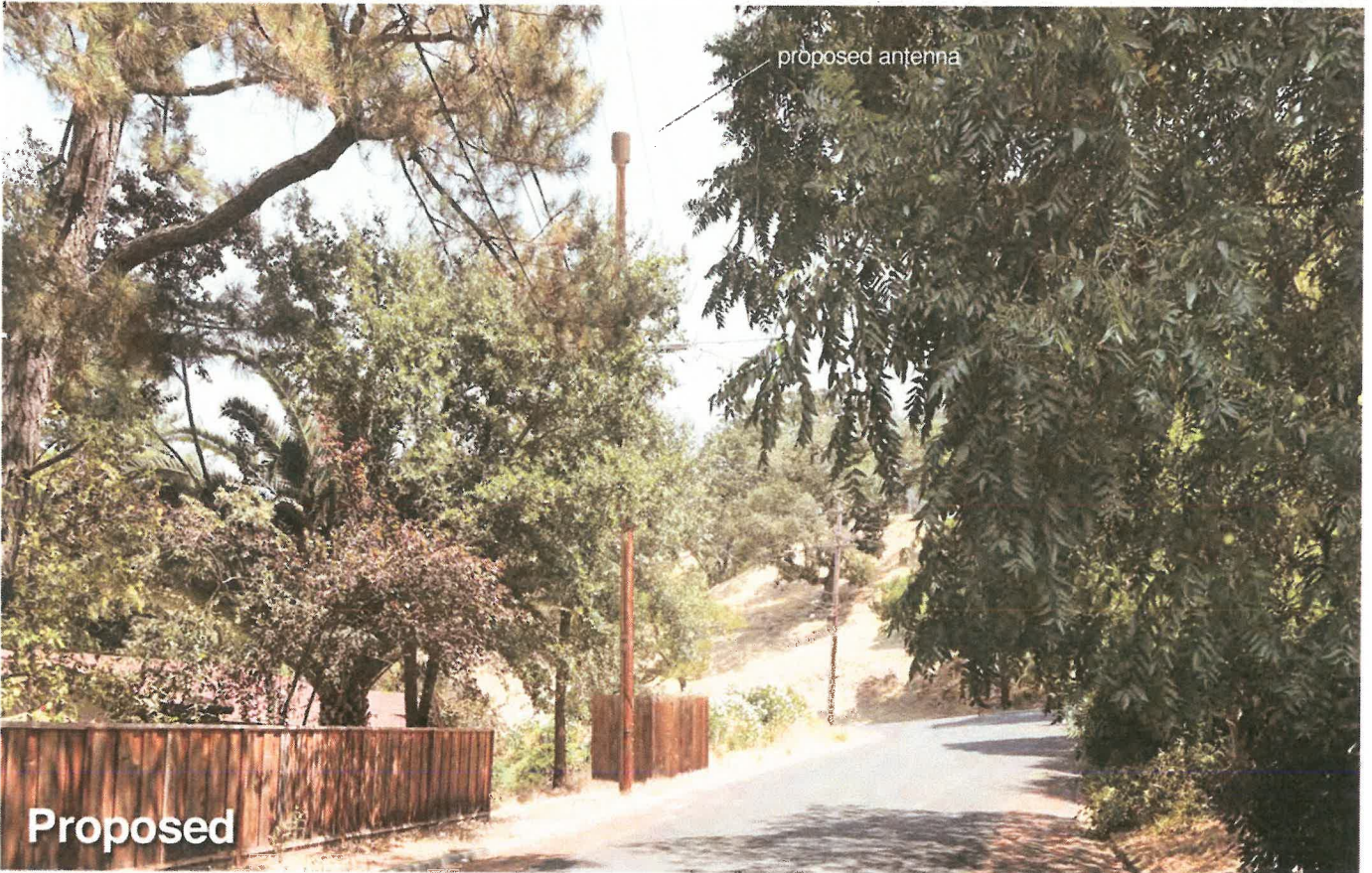
Alamo Way

**Exhibit E**





Existing



proposed antenna

Proposed

verizon

SF Alamo 013

Looking Northeast from Creekdale Road

6/26/18

(Near) 184 Creekdale Road  
Walnut Creek, CA

View #2

Applied Imagination 510 914-0500

**Verizon Wireless • Proposed Small Cell (No. 433679 “SF Alamo 013”)  
184 Creekdale Road • Walnut Creek, California**

**Statement of Hammett & Edison, Inc., Consulting Engineers**

The firm of Hammett & Edison, Inc., Consulting Engineers, has been retained on behalf of Verizon Wireless, a personal wireless telecommunications carrier, to evaluate its small cell (No. 433679 “SF Alamo 013”) proposed to be sited in Walnut Creek, California, for compliance with appropriate guidelines limiting human exposure to radio frequency (“RF”) electromagnetic fields.

**Executive Summary**

Verizon proposes to install one cylindrical antenna on a utility pole sited in the public right-of-way at 184 Creekdale Road in Walnut Creek. The proposed operation will comply with the FCC guidelines limiting public exposure to RF energy.

**Prevailing Exposure Standard**

The U.S. Congress requires that the Federal Communications Commission (“FCC”) evaluate its actions for possible significant impact on the environment. A summary of the FCC’s human exposure limits is shown in Figure 1. These limits apply for continuous exposures and are intended to provide a prudent margin of safety for all persons, regardless of age, gender, size, or health. The FCC limit for exposures of unlimited duration to radio frequency energy for various wireless services are as follows:

Wireless Service	Frequency Band	Occupational Limit	Public Limit
Microwave (Point-to-Point)	5–80 GHz	5.00 mW/cm <sup>2</sup>	1.00 mW/cm <sup>2</sup>
WiFi (and unlicensed uses)	2–6	5.00	1.00
BRS (Broadband Radio)	2,600 MHz	5.00	1.00
WCS (Wireless Communication)	2,300	5.00	1.00
AWS (Advanced Wireless)	2,100	5.00	1.00
PCS (Personal Communication)	1,950	5.00	1.00
Cellular	870	2.90	0.58
SMR (Specialized Mobile Radio)	855	2.85	0.57
700 MHz	700	2.40	0.48
[most restrictive frequency range]	30–300	1.00	0.20

Power line frequencies (60 Hz) are well below the applicable range of this standard, and there is considered to be no compounding effect from simultaneous exposure to power line and radio frequency fields.

**General Facility Requirements**

Small cells typically consist of two distinct parts: the electronic transceivers (also called “radios”) that are connected to the traditional wired telephone lines, and the passive antennas that send the wireless signals created by the radios out to be received by individual subscriber units. The transceivers are typically mounted on the support pole or placed in a cabinet at ground level, and they are connected to

**Verizon Wireless • Proposed Small Cell (No. 433679 “SF Alamo 013”)  
184 Creekdale Road • Walnut Creek, California**

the antennas by coaxial cables. Because of the short wavelength of the frequencies assigned by the FCC for wireless services, the antennas require line-of-sight paths for their signals to propagate well and so are installed at some height above ground. The antennas are designed to concentrate their energy toward the horizon, with very little energy wasted toward the sky or the ground. This means that it is generally not possible for exposure conditions to approach the maximum permissible exposure limits without being physically very near the antennas.

**Computer Modeling Method**

The FCC provides direction for determining compliance in its Office of Engineering and Technology Bulletin No. 65, “Evaluating Compliance with FCC-Specified Guidelines for Human Exposure to Radio Frequency Radiation,” dated August 1997. Figure 2 describes the calculation methodologies, reflecting the facts that a directional antenna’s radiation pattern is not fully formed at locations very close by (the “near-field” effect) and that at greater distances the power level from an energy source decreases with the square of the distance from it (the “inverse square law”). The conservative nature of this method for evaluating exposure conditions has been verified by numerous field tests.

**Site and Facility Description**

Based upon information provided by Verizon, including drawings by Meridian Management, LLC, dated June 4, 2018, it is proposed to install one Amphenol Model CUUT360X06F omnidirectional cylindrical antenna on an extension above the utility pole sited in the public right-of-way in front of the residence at 184 Creekdale Road in Walnut Creek. The antenna would employ no downtilt and would be mounted at an effective height of about 46½ feet above ground. The maximum effective radiated power in any direction would be 980 watts, representing simultaneous operation at 560 watts for AWS and 420 watts for PCS service. There are reported no other wireless base stations at the site or nearby.

**Study Results**

For a person anywhere at ground, the maximum RF exposure level due to the proposed Verizon operation is calculated to be 0.015 mW/cm<sup>2</sup>, which is 1.5% of the applicable public exposure limit. The maximum calculated level at the second-floor elevation of any nearby building is 1.1% of the public exposure limit. It should be noted that these results include several “worst-case” assumptions and therefore are expected to overstate actual power density levels from the proposed operation.

**Verizon Wireless • Proposed Small Cell (No. 433679 “SF Alamo 013”)  
184 Creekdale Road • Walnut Creek, California**

**Recommended Mitigation Measures**

Due to its mounting location and height, the Verizon antenna would not be accessible to unauthorized persons, and so no mitigation measures are necessary to comply with the FCC public exposure guidelines. To prevent occupational exposures in excess of the FCC guidelines, it is recommended that appropriate RF safety training, to include review of personal monitor use, be provided to all authorized personnel who have access to the antenna. No access within 5 feet at the same height as the Verizon antenna, such as might occur during certain maintenance activities at the top of the pole, should be allowed while the small cell is in operation, unless other measures can be demonstrated to ensure that occupational protection requirements are met. It is recommended that an explanatory sign\* be posted at the antenna and/or on the pole below the antenna, readily visible from any angle of approach to persons who might need to work within that distance.

**Conclusion**

Based on the information and analysis above, it is the undersigned’s professional opinion that operation of the small cell proposed by Verizon Wireless near 184 Creekdale Road in Walnut Creek, California, will comply with the prevailing standards for limiting public exposure to radio frequency energy and, therefore, will not for this reason cause a significant impact on the environment. The highest calculated level in publicly accessible areas is much less than the prevailing standards allow for exposures of unlimited duration. This finding is consistent with measurements of actual exposure conditions taken at other operating small cells. Training authorized personnel and posting an explanatory sign are recommended to establish compliance with occupational exposure limits.

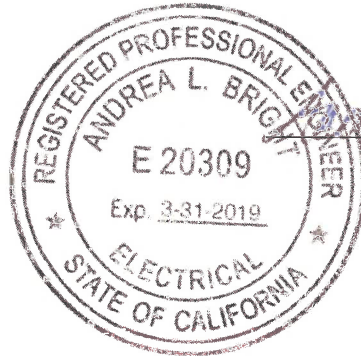
---

\* Signs should comply with OET-65 color, symbol, and content recommendations. Contact information should be provided (*e.g.*, a telephone number) to arrange for access to restricted areas. The selection of language(s) is not an engineering matter, and guidance from the landlord, local zoning or health authority, or appropriate professionals may be required. Signage may also need to comply with the requirements of California Public Utilities Commission General Order No. 95.

Verizon Wireless • Proposed Small Cell (No. 433679 "SF Alamo 013")  
184 Creekdale Road • Walnut Creek, California

Authorship

The undersigned author of this statement is a qualified Professional Engineer, holding California Registration No. E-20309, which expires on March 31, 2019. This work has been carried out under her direction, and all statements are true and correct of her own knowledge except, where noted, when data has been supplied by others, which data she believes to be correct.



*Andrea L. Bright*  
\_\_\_\_\_  
Andrea L. Bright, P.E.  
707/996-5200

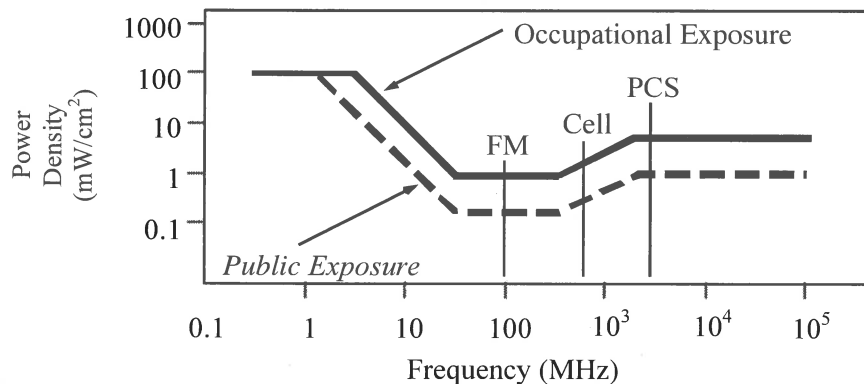
June 29, 2018

## FCC Radio Frequency Protection Guide

The U.S. Congress required (1996 Telecom Act) the Federal Communications Commission (“FCC”) to adopt a nationwide human exposure standard to ensure that its licensees do not, cumulatively, have a significant impact on the environment. The FCC adopted the limits from Report No. 86, “Biological Effects and Exposure Criteria for Radiofrequency Electromagnetic Fields,” published in 1986 by the Congressionally chartered National Council on Radiation Protection and Measurements (“NCRP”). Separate limits apply for occupational and public exposure conditions, with the latter limits generally five times more restrictive. The more recent standard, developed by the Institute of Electrical and Electronics Engineers and approved as American National Standard ANSI/IEEE C95.1-2006, “Safety Levels with Respect to Human Exposure to Radio Frequency Electromagnetic Fields, 3 kHz to 300 GHz,” includes similar limits. These limits apply for continuous exposures from all sources and are intended to provide a prudent margin of safety for all persons, regardless of age, gender, size, or health.

As shown in the table and chart below, separate limits apply for occupational and public exposure conditions, with the latter limits (in *italics* and/or dashed) up to five times more restrictive:

Frequency Applicable Range (MHz)	Electromagnetic Fields ( <i>f</i> is frequency of emission in MHz)					
	Electric Field Strength (V/m)		Magnetic Field Strength (A/m)		Equivalent Far-Field Power Density (mW/cm <sup>2</sup> )	
0.3 – 1.34	614	<i>614</i>	1.63	<i>1.63</i>	100	<i>100</i>
1.34 – 3.0	614	<i>823.8/f</i>	1.63	<i>2.19/f</i>	100	<i>180/f<sup>2</sup></i>
3.0 – 30	1842/ <i>f</i>	<i>823.8/f</i>	4.89/ <i>f</i>	<i>2.19/f</i>	900/ <i>f<sup>2</sup></i>	<i>180/f<sup>2</sup></i>
30 – 300	61.4	<i>27.5</i>	0.163	<i>0.0729</i>	1.0	<i>0.2</i>
300 – 1,500	3.54√ <i>f</i>	<i>1.59√f</i>	√ <i>f</i> /106	<i>√f/238</i>	<i>f/300</i>	<i>f/1500</i>
1,500 – 100,000	137	<i>61.4</i>	0.364	<i>0.163</i>	5.0	<i>1.0</i>



Higher levels are allowed for short periods of time, such that total exposure levels averaged over six or thirty minutes, for occupational or public settings, respectively, do not exceed the limits, and higher levels also are allowed for exposures to small areas, such that the spatially averaged levels do not exceed the limits. However, neither of these allowances is incorporated in the conservative calculation formulas in the FCC Office of Engineering and Technology Bulletin No. 65 (August 1997) for projecting field levels. Hammett & Edison has built those formulas into a proprietary program that calculates, at each location on an arbitrary rectangular grid, the total expected power density from any number of individual radio sources. The program allows for the description of buildings and uneven terrain, if required to obtain more accurate projections.



## RFR.CALC™ Calculation Methodology

### Assessment by Calculation of Compliance with FCC Exposure Guidelines

The U.S. Congress required (1996 Telecom Act) the Federal Communications Commission (“FCC”) to adopt a nationwide human exposure standard to ensure that its licensees do not, cumulatively, have a significant impact on the environment. The maximum permissible exposure limits adopted by the FCC (see Figure 1) apply for continuous exposures from all sources and are intended to provide a prudent margin of safety for all persons, regardless of age, gender, size, or health. Higher levels are allowed for short periods of time, such that total exposure levels averaged over six or thirty minutes, for occupational or public settings, respectively, do not exceed the limits.

#### Near Field.

Prediction methods have been developed for the near field zone of panel (directional) and whip (omnidirectional) antennas, typical at wireless telecommunications base stations, as well as dish (aperture) antennas, typically used for microwave links. The antenna patterns are not fully formed in the near field at these antennas, and the FCC Office of Engineering and Technology Bulletin No. 65 (August 1997) gives suitable formulas for calculating power density within such zones.

For a panel or whip antenna, power density  $S = \frac{180}{\theta_{BW}} \times \frac{0.1 \times P_{net}}{\pi \times D \times h}$ , in mW/cm<sup>2</sup>,

and for an aperture antenna, maximum power density  $S_{max} = \frac{0.1 \times 16 \times \eta \times P_{net}}{\pi \times h^2}$ , in mW/cm<sup>2</sup>,

where  $\theta_{BW}$  = half-power beamwidth of the antenna, in degrees, and

$P_{net}$  = net power input to the antenna, in watts,

$D$  = distance from antenna, in meters,

$h$  = aperture height of the antenna, in meters, and

$\eta$  = aperture efficiency (unitless, typically 0.5-0.8).

The factor of 0.1 in the numerators converts to the desired units of power density.

#### Far Field.

OET-65 gives this formula for calculating power density in the far field of an individual RF source:

power density  $S = \frac{2.56 \times 1.64 \times 100 \times RFF^2 \times ERP}{4 \times \pi \times D^2}$ , in mW/cm<sup>2</sup>,

where ERP = total ERP (all polarizations), in kilowatts,

RFF = relative field factor at the direction to the actual point of calculation, and

$D$  = distance from the center of radiation to the point of calculation, in meters.

The factor of 2.56 accounts for the increase in power density due to ground reflection, assuming a reflection coefficient of 1.6 (1.6 x 1.6 = 2.56). The factor of 1.64 is the gain of a half-wave dipole relative to an isotropic radiator. The factor of 100 in the numerator converts to the desired units of power density. This formula has been built into a proprietary program that calculates, at each location on an arbitrary rectangular grid, the total expected power density from any number of individual radiation sources. The program also allows for the description of uneven terrain in the vicinity, to obtain more accurate projections.



Alternative B

Subject Pole

Alternative A

Castle-Glen-Rd

**Exhibit F**



**Existing**



proposed antenna ———

**Proposed**



**SF Alamo Site # 012**  
(near) 1955 Meadow Road  
Alamo, CA

Looking North from Meadow Road

View #1

3/27/18

Applied Imagination 510 914-0500



Existing



proposed antenna

Proposed

**Verizon Wireless • Proposed Small Cell (No. 433678 “SF Alamo 012”)  
1955 Meadow Road • Walnut Creek, California**

**Statement of Hammett & Edison, Inc., Consulting Engineers**

The firm of Hammett & Edison, Inc., Consulting Engineers, has been retained on behalf of Verizon Wireless, a personal wireless telecommunications carrier, to evaluate its small cell (No. 433678 “SF Alamo 012”) proposed to be sited in Walnut Creek, California, for compliance with appropriate guidelines limiting human exposure to radio frequency (“RF”) electromagnetic fields.

**Executive Summary**

Verizon proposes to install a cylindrical antenna on a utility pole sited in the public right-of-way near 1955 Meadow Road in Walnut Creek. The proposed operation will comply with the FCC guidelines limiting public exposure to RF energy.

**Prevailing Exposure Standard**

The U.S. Congress requires that the Federal Communications Commission (“FCC”) evaluate its actions for possible significant impact on the environment. A summary of the FCC’s human exposure limits is shown in Figure 1. These limits apply for continuous exposures and are intended to provide a prudent margin of safety for all persons, regardless of age, gender, size, or health. The FCC limit for exposures of unlimited duration to radio frequency energy for various wireless services are as follows:

Wireless Service	Frequency Band	Occupational Limit	Public Limit
Microwave (Point-to-Point)	5–80 GHz	5.00 mW/cm <sup>2</sup>	1.00 mW/cm <sup>2</sup>
WiFi (and unlicensed uses)	2–6	5.00	1.00
BRS (Broadband Radio)	2,600 MHz	5.00	1.00
WCS (Wireless Communication)	2,300	5.00	1.00
AWS (Advanced Wireless)	2,100	5.00	1.00
PCS (Personal Communication)	1,950	5.00	1.00
Cellular	870	2.90	0.58
SMR (Specialized Mobile Radio)	855	2.85	0.57
700 MHz	700	2.40	0.48
[most restrictive frequency range]	30–300	1.00	0.20

Power line frequencies (60 Hz) are well below the applicable range of this standard, and there is considered to be no compounding effect from simultaneous exposure to power line and radio frequency fields.

**General Facility Requirements**

Small cells typically consist of two distinct parts: the electronic transceivers (also called “radios”) that are connected to the traditional wired telephone lines, and the passive antennas that send the wireless signals created by the radios out to be received by individual subscriber units. The transceivers are

**Verizon Wireless • Proposed Small Cell (No. 433678 “SF Alamo 012”)  
1955 Meadow Road • Walnut Creek, California**

typically mounted on the support pole or placed in a cabinet at ground level. Because of the short wavelength of the frequencies assigned by the FCC for wireless services, the antennas require line-of-sight paths for their signals to propagate well and so are installed at some height above ground. The antennas are designed to concentrate their energy toward the horizon, with very little energy wasted toward the sky or the ground. This means that it is generally not possible for exposure conditions to approach the maximum permissible exposure limits without being physically in front of the antennas.

**Computer Modeling Method**

The FCC provides direction for determining compliance in its Office of Engineering and Technology Bulletin No. 65, “Evaluating Compliance with FCC-Specified Guidelines for Human Exposure to Radio Frequency Radiation,” dated August 1997. Figure 2 describes the calculation methodologies, reflecting the facts that a directional antenna’s radiation pattern is not fully formed at locations very close by (the “near-field” effect) and that at greater distances the power level from an energy source decreases with the square of the distance from it (the “inverse square law”). The conservative nature of this method for evaluating exposure conditions has been verified by numerous field tests.

**Site and Facility Description**

Based upon information provided by Verizon, including drawings by Meridian Management, Inc., dated March 14, 2018, it is proposed to install one Amphenol Model CUUT360X12F, 4-foot tall omnidirectional antenna on an extension above the top of the utility pole sited in the public right-of-way on the east side of Meadow Road, opposite the single-story residence located at 1955 Meadow Road in Walnut Creek. The antenna would employ no downtilt and would be mounted at an effective height of about 57 feet above ground. The maximum effective radiated power in any direction would be 1,580 watts, representing simultaneous operation at 840 watts for AWS and 740 watts for PCS service. There are reported no other wireless telecommunications base stations at this site or nearby.

**Study Results**

For a person anywhere at ground, the maximum RF exposure level due to the proposed Verizon operation is calculated to be 0.0016 mW/cm<sup>2</sup>, which is 0.16% of the applicable public exposure limit. The maximum calculated level at any nearby building is 2.2% of the public exposure limit. It should be noted that these results include several “worst-case” assumptions and therefore are expected to overstate actual power density levels from the proposed operation.

**Verizon Wireless • Proposed Small Cell (No. 433678 “SF Alamo 012”)  
1955 Meadow Road • Walnut Creek, California**

**Recommended Mitigation Measures**

Due to its mounting location and height, the Verizon antenna would not be accessible to unauthorized persons, and so no mitigation measures are necessary to comply with the FCC public exposure guidelines. To prevent occupational exposures in excess of the FCC guidelines, it is recommended that appropriate RF safety training, to include review of personal monitor use, be provided to all authorized personnel who have access to the antenna. No access within 3 feet at the same height as the antenna, such as might occur during certain maintenance activities at the top of the pole, should be allowed while the small cell is in operation, unless other measures can be demonstrated to ensure that occupational protection requirements are met. It is recommended that an explanatory sign\* be posted at the antenna and/or on the pole below the antenna, readily visible to persons who might need to work within that distance.

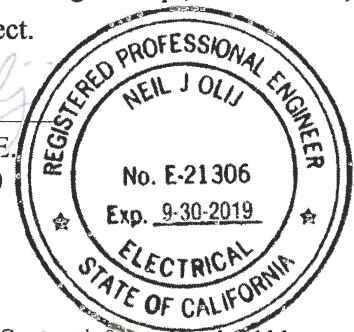
**Conclusion**

Based on the information and analysis above, it is the undersigned’s professional opinion that operation of the small cell proposed by Verizon Wireless near 1955 Meadow Road in Walnut Creek, California, will comply with the prevailing standards for limiting public exposure to radio frequency energy and, therefore, will not for this reason cause a significant impact on the environment. The highest calculated level in publicly accessible areas is much less than the prevailing standards allow for exposures of unlimited duration. This finding is consistent with measurements of actual exposure conditions taken at other operating small cells. Training authorized personnel and posting explanatory signs are recommended to establish compliance with occupational exposure limits.

**Authorship**

The undersigned author of this statement is a qualified Professional Engineer, holding California Registration No. E-21306, which expires on September 30, 2019. This work has been carried out under his direction, and all statements are true and correct of his own knowledge except, where noted, when data has been supplied by others, which data he believes to be correct.

Neil J. Olij, P.E.  
707/996-5200



April 13, 2018

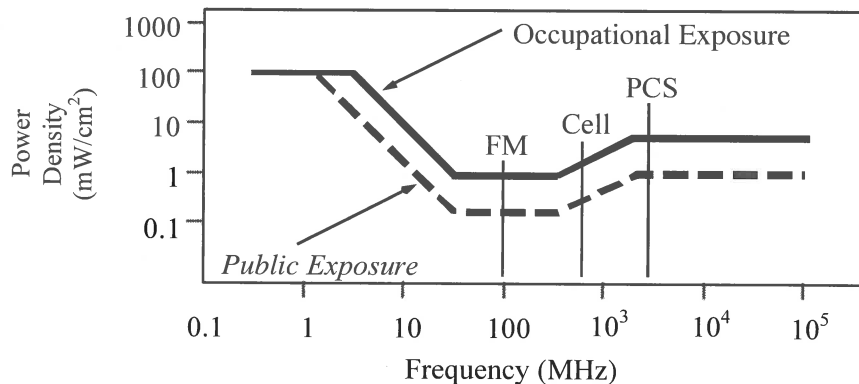
\* Signs should comply with OET-65 color, symbol, and content recommendations. Contact information should be provided (e.g., a telephone number) to arrange for access to restricted areas. The selection of language(s) is not an engineering matter, and guidance from the landlord, local zoning or health authority, or appropriate professionals may be required. Signage may also need to comply with the requirements of California Public Utilities Commission General Order No. 95.

## FCC Radio Frequency Protection Guide

The U.S. Congress required (1996 Telecom Act) the Federal Communications Commission (“FCC”) to adopt a nationwide human exposure standard to ensure that its licensees do not, cumulatively, have a significant impact on the environment. The FCC adopted the limits from Report No. 86, “Biological Effects and Exposure Criteria for Radiofrequency Electromagnetic Fields,” published in 1986 by the Congressionally chartered National Council on Radiation Protection and Measurements (“NCRP”). Separate limits apply for occupational and public exposure conditions, with the latter limits generally five times more restrictive. The more recent standard, developed by the Institute of Electrical and Electronics Engineers and approved as American National Standard ANSI/IEEE C95.1-2006, “Safety Levels with Respect to Human Exposure to Radio Frequency Electromagnetic Fields, 3 kHz to 300 GHz,” includes similar limits. These limits apply for continuous exposures from all sources and are intended to provide a prudent margin of safety for all persons, regardless of age, gender, size, or health.

As shown in the table and chart below, separate limits apply for occupational and public exposure conditions, with the latter limits (in *italics* and/or dashed) up to five times more restrictive:

Frequency Applicable Range (MHz)	Electromagnetic Fields ( <i>f</i> is frequency of emission in MHz)					
	Electric Field Strength (V/m)		Magnetic Field Strength (A/m)		Equivalent Far-Field Power Density (mW/cm <sup>2</sup> )	
0.3 – 1.34	614	<i>614</i>	1.63	<i>1.63</i>	100	<i>100</i>
1.34 – 3.0	614	<i>823.8/f</i>	1.63	<i>2.19/f</i>	100	<i>180/f<sup>2</sup></i>
3.0 – 30	1842/f	<i>823.8/f</i>	4.89/f	<i>2.19/f</i>	900/f <sup>2</sup>	<i>180/f<sup>2</sup></i>
30 – 300	61.4	<i>27.5</i>	0.163	<i>0.0729</i>	1.0	<i>0.2</i>
300 – 1,500	3.54√ <i>f</i>	<i>1.59√f</i>	√ <i>f</i> /106	<i>√f/238</i>	<i>f/300</i>	<i>f/1500</i>
1,500 – 100,000	137	<i>61.4</i>	0.364	<i>0.163</i>	5.0	<i>1.0</i>



Higher levels are allowed for short periods of time, such that total exposure levels averaged over six or thirty minutes, for occupational or public settings, respectively, do not exceed the limits, and higher levels also are allowed for exposures to small areas, such that the spatially averaged levels do not exceed the limits. However, neither of these allowances is incorporated in the conservative calculation formulas in the FCC Office of Engineering and Technology Bulletin No. 65 (August 1997) for projecting field levels. Hammett & Edison has built those formulas into a proprietary program that calculates, at each location on an arbitrary rectangular grid, the total expected power density from any number of individual radio sources. The program allows for the description of buildings and uneven terrain, if required to obtain more accurate projections.



## RFR.CALC™ Calculation Methodology

### Assessment by Calculation of Compliance with FCC Exposure Guidelines

The U.S. Congress required (1996 Telecom Act) the Federal Communications Commission (“FCC”) to adopt a nationwide human exposure standard to ensure that its licensees do not, cumulatively, have a significant impact on the environment. The maximum permissible exposure limits adopted by the FCC (see Figure 1) apply for continuous exposures from all sources and are intended to provide a prudent margin of safety for all persons, regardless of age, gender, size, or health. Higher levels are allowed for short periods of time, such that total exposure levels averaged over six or thirty minutes, for occupational or public settings, respectively, do not exceed the limits.

#### Near Field.

Prediction methods have been developed for the near field zone of panel (directional) and whip (omnidirectional) antennas, typical at wireless telecommunications base stations, as well as dish (aperture) antennas, typically used for microwave links. The antenna patterns are not fully formed in the near field at these antennas, and the FCC Office of Engineering and Technology Bulletin No. 65 (August 1997) gives suitable formulas for calculating power density within such zones.

For a panel or whip antenna, power density  $S = \frac{180}{\theta_{BW}} \times \frac{0.1 \times P_{net}}{\pi \times D \times h}$ , in mW/cm<sup>2</sup>,

and for an aperture antenna, maximum power density  $S_{max} = \frac{0.1 \times 16 \times \eta \times P_{net}}{\pi \times h^2}$ , in mW/cm<sup>2</sup>,

where  $\theta_{BW}$  = half-power beamwidth of the antenna, in degrees, and

$P_{net}$  = net power input to the antenna, in watts,

$D$  = distance from antenna, in meters,

$h$  = aperture height of the antenna, in meters, and

$\eta$  = aperture efficiency (unitless, typically 0.5-0.8).

The factor of 0.1 in the numerators converts to the desired units of power density.

#### Far Field.

OET-65 gives this formula for calculating power density in the far field of an individual RF source:

power density  $S = \frac{2.56 \times 1.64 \times 100 \times RFF^2 \times ERP}{4 \times \pi \times D^2}$ , in mW/cm<sup>2</sup>,

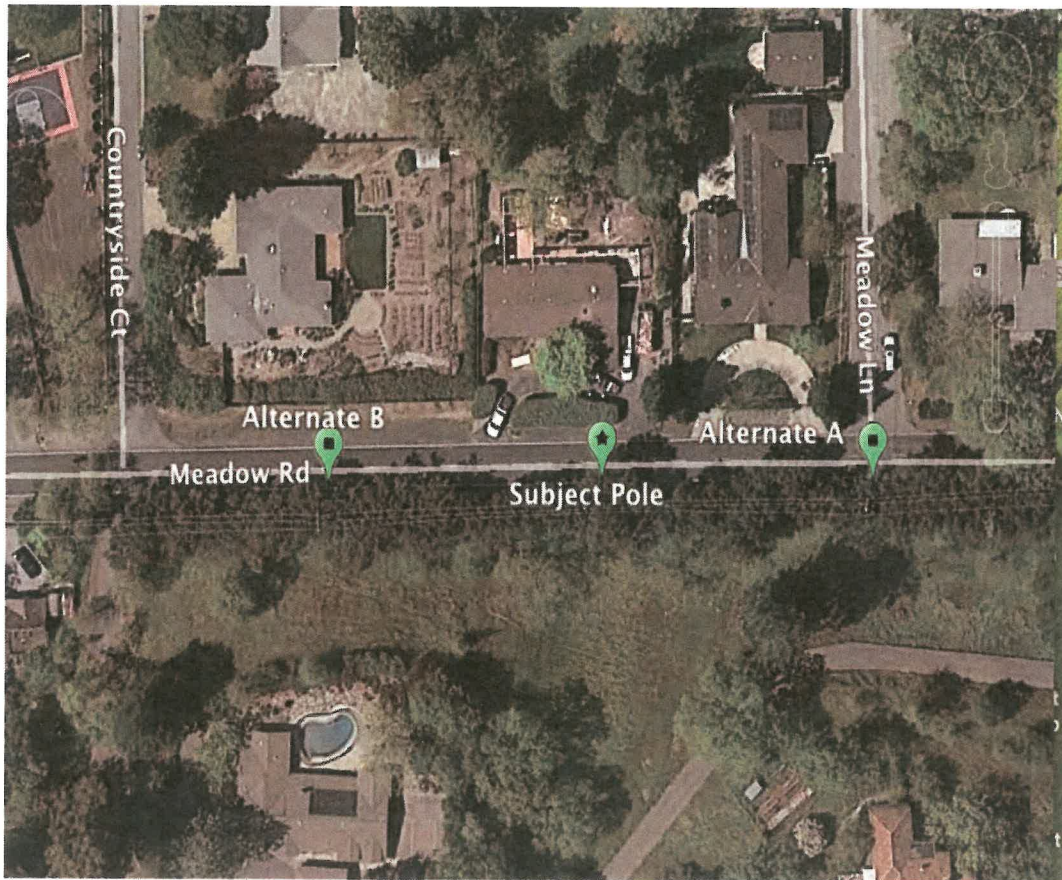
where ERP = total ERP (all polarizations), in kilowatts,

RFF = relative field factor at the direction to the actual point of calculation, and

$D$  = distance from the center of radiation to the point of calculation, in meters.

The factor of 2.56 accounts for the increase in power density due to ground reflection, assuming a reflection coefficient of 1.6 (1.6 x 1.6 = 2.56). The factor of 1.64 is the gain of a half-wave dipole relative to an isotropic radiator. The factor of 100 in the numerator converts to the desired units of power density. This formula has been built into a proprietary program that calculates, at each location on an arbitrary rectangular grid, the total expected power density from any number of individual radiation sources. The program also allows for the description of uneven terrain in the vicinity, to obtain more accurate projections.

Aerial Map

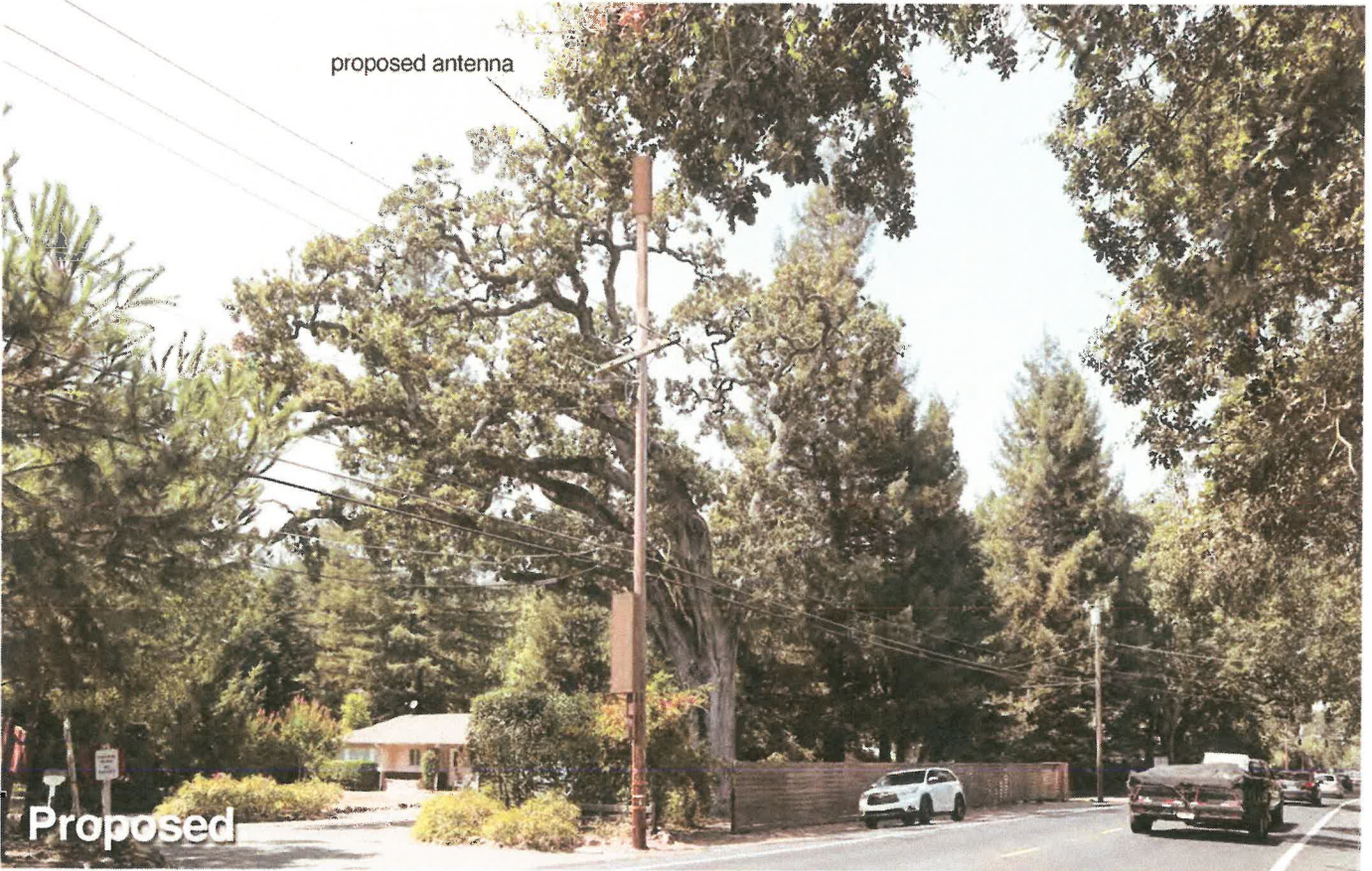


# Exhibit G





Existing



proposed antenna

Proposed

verizon

SF Alamo 009

Looking Northwest from Danville Blvd.

6/26/18

(Near) 21 Francesca Lane  
Alamo, CA

View #2

Applied Imagination 510 914-0500



Existing



Proposed



Existing



Proposed



SF Alamo 009

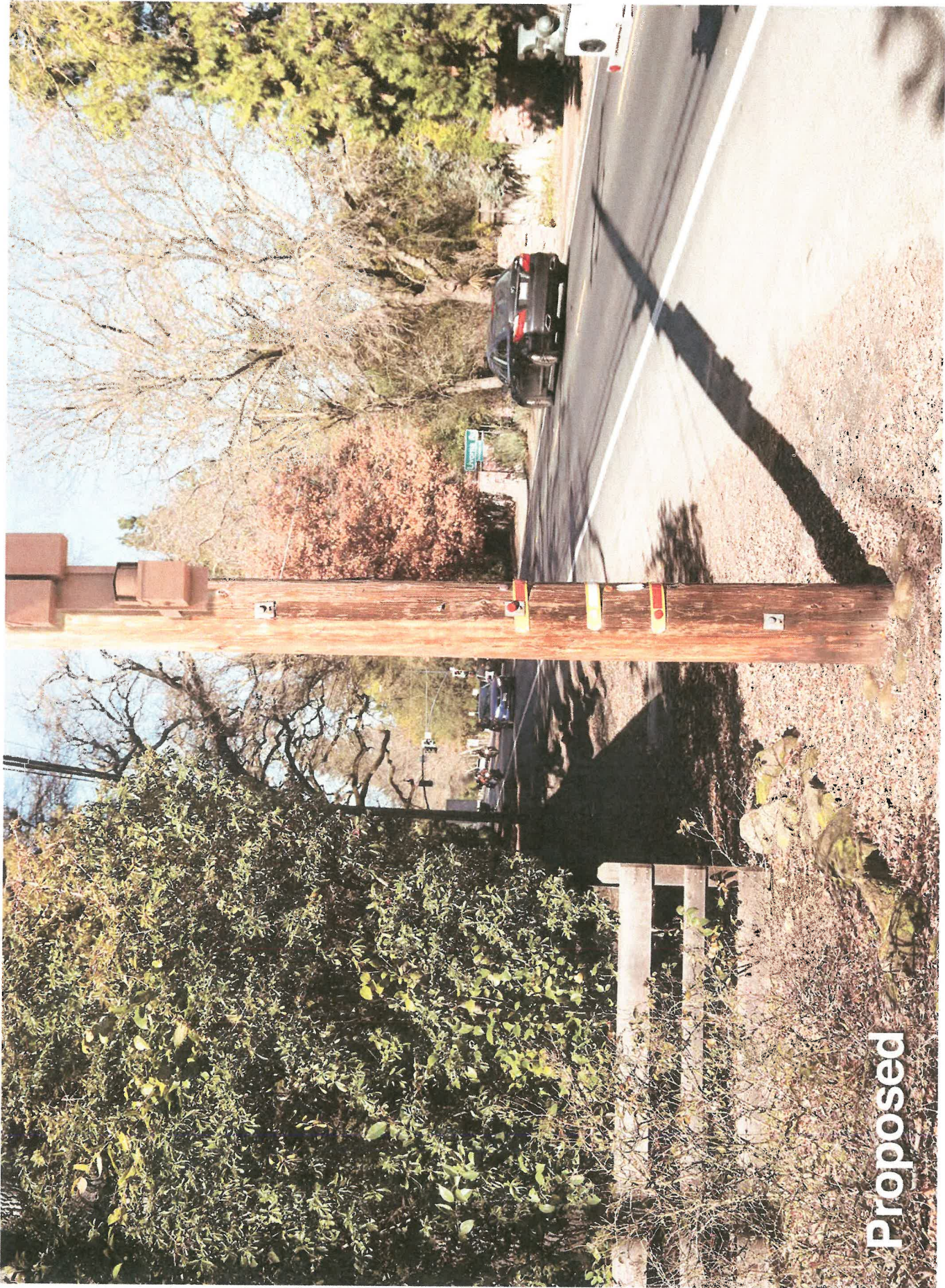
Looking North from Francesca Lane

1/22/19

(Near) 21 Francesca Lane  
Alamo, CA

View #3

Applied Imagination 510 914-9500



Proposed

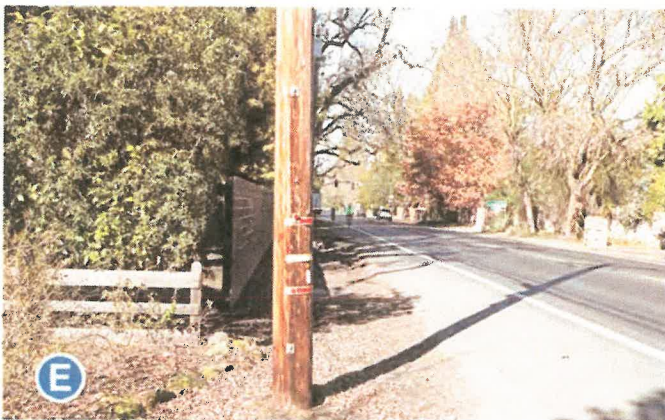
Drive Series - turning left from Francesca Lane to Danville Blvd.

verizon SF Alamo 009

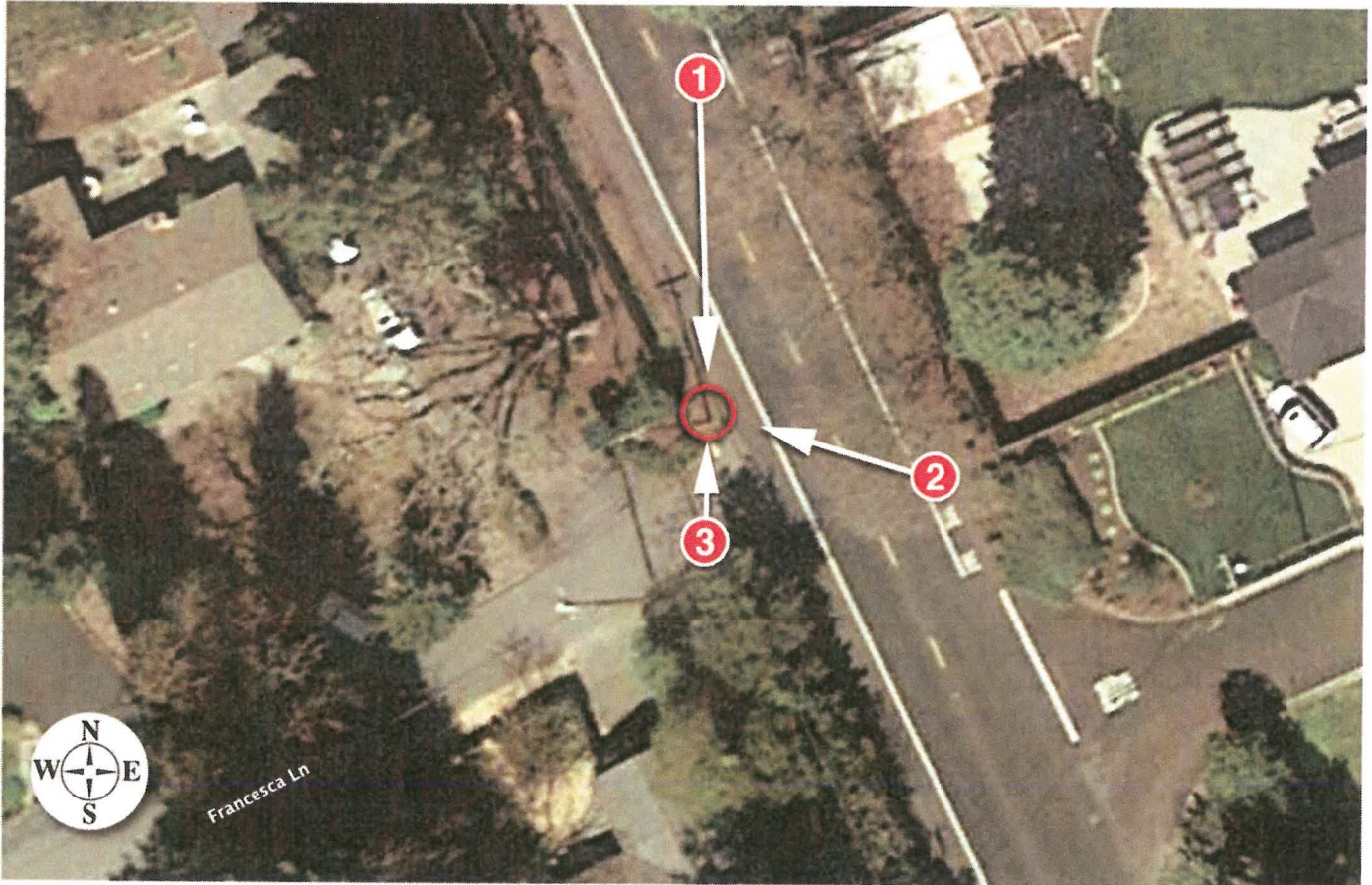
(Near) 21 Francesca Lane  
Alamo, CA

1/22/19

Applied Imagination 510 914-0500







**Verizon Wireless • Proposed Small Cell (No. 433675 “SF Alamo 009”)  
20 Francesca Way • Alamo, California**

**Statement of Hammett & Edison, Inc., Consulting Engineers**

The firm of Hammett & Edison, Inc., Consulting Engineers, has been retained on behalf of Verizon Wireless, a personal wireless telecommunications carrier, to evaluate its small cell (No. 433675 “SF Alamo 009”) proposed to be sited in Alamo, California, for compliance with appropriate guidelines limiting human exposure to radio frequency (“RF”) electromagnetic fields.

**Executive Summary**

Verizon proposes to install a cylindrical antenna on the utility pole sited in the public right-of-way near 20 Francesca Way in Alamo. The proposed operation will comply with the FCC guidelines limiting public exposure to RF energy.

**Prevailing Exposure Standard**

The U.S. Congress requires that the Federal Communications Commission (“FCC”) evaluate its actions for possible significant impact on the environment. A summary of the FCC’s human exposure limits is shown in Figure 1. These limits apply for continuous exposures and are intended to provide a prudent margin of safety for all persons, regardless of age, gender, size, or health. The FCC limit for exposures of unlimited duration to radio frequency energy for various wireless services are as follows:

Wireless Service	Frequency Band	Occupational Limit	Public Limit
Microwave (Point-to-Point)	5–80 GHz	5.00 mW/cm <sup>2</sup>	1.00 mW/cm <sup>2</sup>
WiFi (and unlicensed uses)	2–6	5.00	1.00
BRS (Broadband Radio)	2,600 MHz	5.00	1.00
WCS (Wireless Communication)	2,300	5.00	1.00
AWS (Advanced Wireless)	2,100	5.00	1.00
PCS (Personal Communication)	1,950	5.00	1.00
Cellular	870	2.90	0.58
SMR (Specialized Mobile Radio)	855	2.85	0.57
700 MHz	700	2.40	0.48
[most restrictive frequency range]	30–300	1.00	0.20

Power line frequencies (60 Hz) are well below the applicable range of this standard, and there is considered to be no compounding effect from simultaneous exposure to power line and radio frequency fields.

**General Facility Requirements**

Small cells typically consist of two distinct parts: the electronic transceivers (also called “radios”) that are connected to the traditional wired telephone lines, and the passive antennas that send the wireless signals created by the radios out to be received by individual subscriber units. The transceivers are

**Verizon Wireless • Proposed Small Cell (No. 433675 “SF Alamo 009”)  
20 Francesca Way • Alamo, California**

typically mounted on the support pole or placed in a cabinet at ground level. Because of the short wavelength of the frequencies assigned by the FCC for wireless services, the antennas require line-of-sight paths for their signals to propagate well and so are installed at some height above ground. The antennas are designed to concentrate their energy toward the horizon, with very little energy wasted toward the sky or the ground. This means that it is generally not possible for exposure conditions to approach the maximum permissible exposure limits without being physically in front of the antennas.

**Computer Modeling Method**

The FCC provides direction for determining compliance in its Office of Engineering and Technology Bulletin No. 65, “Evaluating Compliance with FCC-Specified Guidelines for Human Exposure to Radio Frequency Radiation,” dated August 1997. Figure 2 describes the calculation methodologies, reflecting the facts that a directional antenna’s radiation pattern is not fully formed at locations very close by (the “near-field” effect) and that at greater distances the power level from an energy source decreases with the square of the distance from it (the “inverse square law”). The conservative nature of this method for evaluating exposure conditions has been verified by numerous field tests.

**Site and Facility Description**

Based upon information provided by Verizon, including drawings by Meridian Management LLC, dated April 9, 2018, it is proposed to install one Amphenol Model CUUT360X12F, 4-foot tall omnidirectional antenna on an extension above the top of the utility pole sited in the public right-of-way at the northwest corner of Francesca Way and Danville Boulevard in Alamo. The antenna would employ no downtilt and would be mounted at an effective height of about 45½ feet above ground. The maximum effective radiated power in any direction would be 1,580 watts, representing simultaneous operation at 840 watts for AWS and 740 watts for PCS service. There are reported no other wireless telecommunications base stations at this site or nearby.

**Study Results**

For a person anywhere at ground, the maximum RF exposure level due to the proposed Verizon operation is calculated to be 0.0010 mW/cm<sup>2</sup>, which is 0.10% of the applicable public exposure limit. The maximum calculated level at the second-floor elevation of any nearby building is 0.18% of the public exposure limit. It should be noted that these results include several “worst-case” assumptions and therefore are expected to overstate actual power density levels from the proposed operation.

**Recommended Mitigation Measures**

Due to its mounting location and height, the Verizon antenna would not be accessible to unauthorized persons, and so no mitigation measures are necessary to comply with the FCC public exposure

**Verizon Wireless • Proposed Small Cell (No. 433675 “SF Alamo 009”)  
20 Francesca Way • Alamo, California**

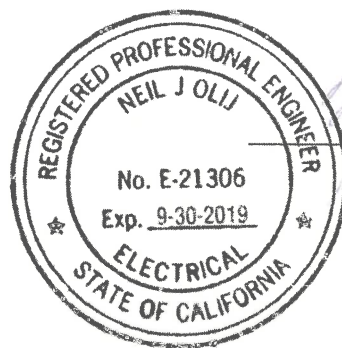
guidelines. To prevent occupational exposures in excess of the FCC guidelines, it is recommended that appropriate RF safety training, to include review of personal monitor use, be provided to all authorized personnel who have access to the antenna. No access within 3 feet at the same height as the antenna, such as might occur during certain maintenance activities at the top of the pole, should be allowed while the small cell is in operation, unless other measures can be demonstrated to ensure that occupational protection requirements are met. It is recommended that an explanatory sign\* be posted at the antenna and/or on the pole below the antenna, readily visible to persons who might need to work within that distance.

**Conclusion**

Based on the information and analysis above, it is the undersigned’s professional opinion that operation of the small cell proposed by Verizon Wireless near 20 Francesca Way in Alamo, California, will comply with the prevailing standards for limiting public exposure to radio frequency energy and, therefore, will not for this reason cause a significant impact on the environment. The highest calculated level in publicly accessible areas is much less than the prevailing standards allow for exposures of unlimited duration. This finding is consistent with measurements of actual exposure conditions taken at other operating small cells. Training authorized personnel and posting explanatory signs are recommended to establish compliance with occupational exposure limits.

**Authorship**

The undersigned author of this statement is a qualified Professional Engineer, holding California Registration No. E-21306, which expires on September 30, 2019. This work has been carried out under his direction, and all statements are true and correct of his own knowledge except, where noted, when data has been supplied by others, which data he believes to be correct.



Neil J. Olij, P.E.  
707/996-5200

July 12, 2018

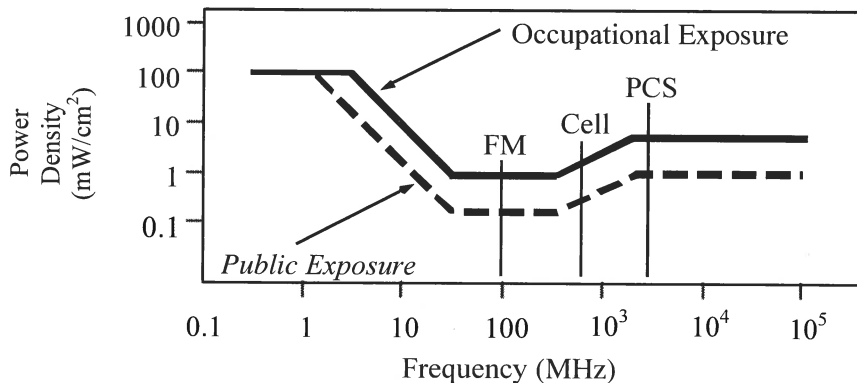
\* Signs should comply with OET-65 color, symbol, and content recommendations. Contact information should be provided (e.g., a telephone number) to arrange for access to restricted areas. The selection of language(s) is not an engineering matter, and guidance from the landlord, local zoning or health authority, or appropriate professionals may be required. Signage may also need to comply with the requirements of California Public Utilities Commission General Order No. 95.

## FCC Radio Frequency Protection Guide

The U.S. Congress required (1996 Telecom Act) the Federal Communications Commission (“FCC”) to adopt a nationwide human exposure standard to ensure that its licensees do not, cumulatively, have a significant impact on the environment. The FCC adopted the limits from Report No. 86, “Biological Effects and Exposure Criteria for Radiofrequency Electromagnetic Fields,” published in 1986 by the Congressionally chartered National Council on Radiation Protection and Measurements (“NCRP”). Separate limits apply for occupational and public exposure conditions, with the latter limits generally five times more restrictive. The more recent standard, developed by the Institute of Electrical and Electronics Engineers and approved as American National Standard ANSI/IEEE C95.1-2006, “Safety Levels with Respect to Human Exposure to Radio Frequency Electromagnetic Fields, 3 kHz to 300 GHz,” includes similar limits. These limits apply for continuous exposures from all sources and are intended to provide a prudent margin of safety for all persons, regardless of age, gender, size, or health.

As shown in the table and chart below, separate limits apply for occupational and public exposure conditions, with the latter limits (in *italics* and/or dashed) up to five times more restrictive:

Frequency Applicable Range (MHz)	Electromagnetic Fields ( <i>f</i> is frequency of emission in MHz)					
	Electric Field Strength (V/m)		Magnetic Field Strength (A/m)		Equivalent Far-Field Power Density (mW/cm <sup>2</sup> )	
0.3 – 1.34	614	<i>614</i>	1.63	<i>1.63</i>	100	<i>100</i>
1.34 – 3.0	614	<i>823.8/f</i>	1.63	<i>2.19/f</i>	100	<i>180/f<sup>2</sup></i>
3.0 – 30	1842/f	<i>823.8/f</i>	4.89/f	<i>2.19/f</i>	900/f <sup>2</sup>	<i>180/f<sup>2</sup></i>
30 – 300	61.4	<i>27.5</i>	0.163	<i>0.0729</i>	1.0	<i>0.2</i>
300 – 1,500	3.54√ <i>f</i>	<i>1.59√f</i>	√ <i>f</i> /106	<i>√f/238</i>	f/300	<i>f/1500</i>
1,500 – 100,000	137	<i>61.4</i>	0.364	<i>0.163</i>	5.0	<i>1.0</i>



Higher levels are allowed for short periods of time, such that total exposure levels averaged over six or thirty minutes, for occupational or public settings, respectively, do not exceed the limits, and higher levels also are allowed for exposures to small areas, such that the spatially averaged levels do not exceed the limits. However, neither of these allowances is incorporated in the conservative calculation formulas in the FCC Office of Engineering and Technology Bulletin No. 65 (August 1997) for projecting field levels. Hammett & Edison has built those formulas into a proprietary program that calculates, at each location on an arbitrary rectangular grid, the total expected power density from any number of individual radio sources. The program allows for the description of buildings and uneven terrain, if required to obtain more accurate projections.

## RFR.CALC™ Calculation Methodology

### Assessment by Calculation of Compliance with FCC Exposure Guidelines

The U.S. Congress required (1996 Telecom Act) the Federal Communications Commission (“FCC”) to adopt a nationwide human exposure standard to ensure that its licensees do not, cumulatively, have a significant impact on the environment. The maximum permissible exposure limits adopted by the FCC (see Figure 1) apply for continuous exposures from all sources and are intended to provide a prudent margin of safety for all persons, regardless of age, gender, size, or health. Higher levels are allowed for short periods of time, such that total exposure levels averaged over six or thirty minutes, for occupational or public settings, respectively, do not exceed the limits.

#### Near Field.

Prediction methods have been developed for the near field zone of panel (directional) and whip (omnidirectional) antennas, typical at wireless telecommunications base stations, as well as dish (aperture) antennas, typically used for microwave links. The antenna patterns are not fully formed in the near field at these antennas, and the FCC Office of Engineering and Technology Bulletin No. 65 (August 1997) gives suitable formulas for calculating power density within such zones.

For a panel or whip antenna, power density  $S = \frac{180}{\theta_{BW}} \times \frac{0.1 \times P_{net}}{\pi \times D \times h}$ , in mW/cm<sup>2</sup>,

and for an aperture antenna, maximum power density  $S_{max} = \frac{0.1 \times 16 \times \eta \times P_{net}}{\pi \times h^2}$ , in mW/cm<sup>2</sup>,

- where  $\theta_{BW}$  = half-power beamwidth of the antenna, in degrees, and  
 $P_{net}$  = net power input to the antenna, in watts,  
 $D$  = distance from antenna, in meters,  
 $h$  = aperture height of the antenna, in meters, and  
 $\eta$  = aperture efficiency (unitless, typically 0.5-0.8).

The factor of 0.1 in the numerators converts to the desired units of power density.

#### Far Field.

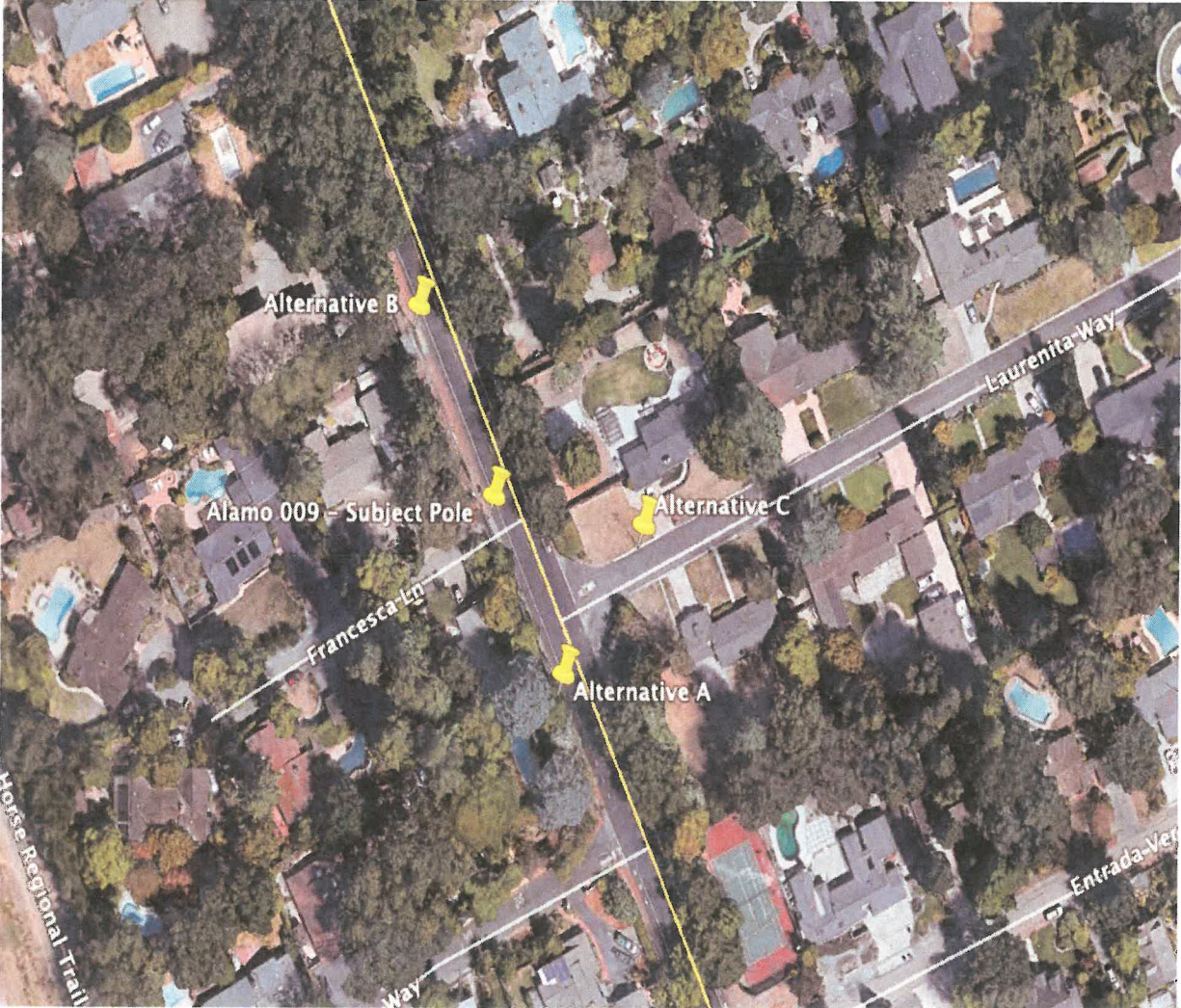
OET-65 gives this formula for calculating power density in the far field of an individual RF source:

$$\text{power density } S = \frac{2.56 \times 1.64 \times 100 \times \text{RFF}^2 \times \text{ERP}}{4 \times \pi \times D^2}, \text{ in mW/cm}^2,$$

- where ERP = total ERP (all polarizations), in kilowatts,  
RFF = relative field factor at the direction to the actual point of calculation, and  
D = distance from the center of radiation to the point of calculation, in meters.


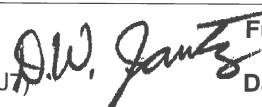
The factor of 2.56 accounts for the increase in power density due to ground reflection, assuming a reflection coefficient of 1.6 (1.6 x 1.6 = 2.56). The factor of 1.64 is the gain of a half-wave dipole relative to an isotropic radiator. The factor of 100 in the numerator converts to the desired units of power density. This formula has been built into a proprietary program that calculates, at each location on an arbitrary rectangular grid, the total expected power density from any number of individual radiation sources. The program also allows for the description of uneven terrain in the vicinity, to obtain more accurate projections.

Aerial View of Alternatives



**Exhibit H**

Prepared by: SXZO

	<b>INSTALLATION DETAILS FOR SERVICE TO POLE-MOUNTED COMMUNICATION EQUIPMENT</b>		<b>027911</b>
	<b>Asset Type:</b> Electric Distribution	<b>Function:</b> Construction	
<b>Issued by:</b> Daniel W. Jantz (DWJ)		<b>Date:</b> 11/01/18	
<b>Rev. #11:</b> This document replaces PG&E Document 027911, Rev. #10. For a description of the changes, see Page 14.			

**Purpose and Scope**

This document illustrates the minimum design and construction requirements for providing service, **supplied from overhead facilities**, to antenna and communication equipment installed above or below supply lines (primary, secondary or service) on PG&E or joint distribution wood poles and wood streetlight poles.

**General Information**

- Only service connections and arrangements described and shown in this document are approved design installations. Alternate connections, arrangements, or designs will not be allowed.**
- For the design and construction requirements for antenna and communication equipment installed on PG&E or Municipal owned steel streetlight poles served from an underground service, refer to [TD-027911B-003](#) and [TD-027911B-004](#) listed in the reference documents on page 2.
- It is the responsibility of the constructor to ensure the antenna installation meets the requirements of PG&E and CPUC General Order 95.**
- Before installation, the location of the equipment and the vertical run are to be mutually agreed upon between representatives of the communication company and PG&E.
- 3rd party (non-PG&E) owned antenna's are not allowed to be installed above the communication level on poles that have PG&E operable equipment installed and connected to the primary voltage lines.**

Operable equipment includes primary risers, cut outs, switches, as well as other types of equipment not listed here that can be operated.

- The metering provision contained herein is an exception to the Greenbook requirement and is designed primarily for CATV power supplies and other telecom equipment requiring metering. **The metering equipment must be mounted on the same pole as the PG&E service and communication equipment. Remote metering is not allowed.** Refer to TD-027911B-002 listed in the reference documents on page 2 for the SmartPole metering options. The potential exists for governmental entities to inquire as to metering for traffic or surveillance cameras, or possibly lighting load if mounted on PG&E or joint poles. In all cases, field representatives shall request the telecommunication company to provide documentation that authorizes them to occupy the space on the pole (e.g., contract permit issued by PG&E or joint owner for tenants).
- When pole metering is unacceptable because it does not meet the PG&E criteria and requirements, the alternative method is to install approved pad-mounted pedestal metering served from a PG&E underground service. Some examples of unacceptable situations include locations:
  - Where access to the meter is impaired.
  - Where meters may be subject to obvious traffic hazards or unsafe working conditions.
  - Where hillside pole locations render metering unsafe.
- It is not intended to serve communication equipment loads with voltages other than 120 V and 120/240 V. Other than single-phase, 2-wire, 120 V and 3-wire, 120/240 V are not to be pole-mounted for these applications.
- Pole steps shall be placed so that runs or risers do not interfere with their free use. Attention is directed to the following requirements of [General Order \(G.O.\) 95](#).



## Installation Details for Service to Pole-Mounted Communication Equipment

- A. The position of the climbing space shall not be shifted more than 90° around the pole within a vertical distance of less than 8 feet. Refer to [Rule 93](#) of [G.O. 95](#).
  - B. Vertical runs are not permitted in climbing spaces through conductors in rack construction.
  - C. Vertical runs of supply lines shall have a clearance of not less than 1-1/2 inches from vertical runs of communication lines.
  - D. The coaxial cable leads to and from amplifier units shall not be carried under the same protective covering with the 120/240 V supply conductors. The leads should be carried outside the molding in cable rings. The leads are not required to be covered unless they are within a vertical distance of 3 feet above or 6 feet below unprotected supply conductors.
  - E. The ground wire is required to be covered.
10. Units shall be fused or otherwise protected against short-circuit currents. A fused switch or circuit breaker, approved for service entrances, is required. Communication type fuses and fuse holders are not satisfactory means of disconnecting the power source.
11. Power Supply Units: Power supplies, or any amplifier which has or is connected to a backup power supply, must have a disconnecting device to separate it from PG&E's system. Power units are to have the communication company's name and emergency phone number on them.
12. Antennas: Antennas installed on distribution poles must have an ownership label with a contact number, site identification information, and a disconnect switch which will shut off RF transmission. The disconnect switch is to be used in an emergency when the normal practice of arranged power-down cannot be accomplished.

References	Location	Document
<a href="#">"Procedures for Working Around Antennas"</a> .....	<a href="#">TIL</a> .....	<a href="#">TD-2001P-01</a>
<a href="#">SmartPole Meter for Service to Pole-Mounted Communication Equipment</a> .....	<a href="#">TIL</a> .....	<a href="#">TD-027911B-002</a>
<a href="#">Service to Communication Equipment on PG&amp;E Owned Steel Streetlight Poles with Antenna Provisions</a> .....	<a href="#">TIL</a> .....	<a href="#">TD-027911B-003</a>
<a href="#">PG&amp;E Metering and Service Connections For Non-PG&amp;E Owned Steel Streetlight Poles With Antenna and Communication Equipment</a> .....	<a href="#">TIL</a> .....	<a href="#">TD-027911B-004</a>
<a href="#">Pole-Top Extension for Wood Poles</a> .....	<a href="#">OH:Framing</a> .....	<a href="#">028691</a>
<a href="#">Notification of Abnormal Conditions Caused by Third-Party Utility</a> .....	<a href="#">TIL</a> .....	<a href="#">TD-2014S</a>
<a href="#">Moldings, Conduits, and Attachments for Use on Wood Poles and Crossarms</a> .....	<a href="#">OH: Risers/ UG-1: Terminations</a> .....	<a href="#">021924</a>
<a href="#">Requirements for Customer-Owned Poles</a> .....	<a href="#">OH:Services/Greenbook/EMWP</a> .....	<a href="#">025055</a>
<a href="#">Compression-Type Connectors for Overhead Distribution and Transmission</a> .....	<a href="#">OH: Conductors</a> .....	<a href="#">041010</a>
<a href="#">Fired Wedge Connectors for Primary and Secondary Distribution Lines</a> .....	<a href="#">OH: Conductors</a> .....	<a href="#">066194</a>

**Design and Construction:**

13. The following requirements apply to antennas installed on solely owned, jointly owned, wood distribution poles.
- A. Antennas above supply lines: Third party antennas are only allowed above supply lines or at pole top (above supply facilities) under a license agreement and in accordance with the design and construction requirements outlined herein.
  - B. Antennas below supply and/or communication lines: Third party antennas are allowed in or below the communication space on joint use poles in accordance with the design and construction requirements outlined herein. When the requesting party is a member of the NCJPA and requests attachment to a PG&E solely-owned distribution wood pole, that party is required to submit a joint pole preliminary Form 2 intent. When the requesting party is not a member of the NCJPA, they must obtain a license agreement for pole attachments. Refer requests from non-members to PG&E's New Revenue Development Department (NRD).

## Installation Details for Service to Pole-Mounted Communication Equipment

C. PG&E owned antennas: Antennas associated with PG&E's SCADA system or the SmartMeter™ project shall be installed in accordance with the applicable engineering documents; [054422](#) PG&E Overhead SCADA and PDAC Installation, [068190](#) Antenna and DCU Installation Details for SmartMeter™ Network, [072145](#). SmartMeter™ Electric SSN Network Nodes on Distribution Infrastructure.

D. Third party antennas are not allowed on streamline poles. PG&E owned antennas are allowed on streamline poles on an exception basis when no other options are available.

### 14. Design and Construction Requirements for 3<sup>rd</sup> Party Antennas on Distribution Poles; Above or Below Supply Lines.

The following requirements apply to antennas installed on joint use poles supporting circuits up to 50 KV and are in accordance with G.O. 95 Rule 94. Antennas and their related crossarms, brackets, hardware, risers, control boxes, etc. shall meet the requirements detailed below.

#### A. Clearances (Also see illustrations in Figure 6 through Figure 10)

- (1) Antennas and supporting elements (e.g. crossarms, brackets) shall maintain a vertical clearance of 6 feet below Supply Conductors operating at 0 – 50kV.
- (2) Antennas and their support elements (e.g. crossarms, brackets) shall maintain a 2 ft. vertical separation from communication conductors and equipment. Antennas may be installed above or below communication conductors as long as the installation complies with the clearance requirements outlined in items (1) and (3) of this section.
- (3) Antennas, associated equipment (e.g. terminations, enclosures) and their support elements installed above supply lines and/or communication lines of different ownership shall maintain vertical clearances as specified in Rule 38 Table 2, Case 21 Columns A–H. These requirements are summarized below.
  - (a) Minimum vertical clearance of antennas and associated support elements from:
    - (i) Span wires, guys and messengers – 2 feet
    - (ii) Communication conductors – 2 feet
    - (iii) 0–750 volt conductors including service drops – 4 feet
    - (iv) 750–35,000 volt conductors – 6 feet
  - (b) Notes:
    - (i) Vertical runs or risers associated with the antenna(s) may terminate 1 foot below the antenna or support element for conditions (a) (i) or (a) (iii) above.
    - (ii) Service drops, that serve only the antenna, may terminate 10 inches below the antenna and its support elements.
- (4) Antennas, associated equipment and support elements, installed above supply or communication lines, shall maintain radial clearances from unattached supply and communication lines as specified in Rule 38, Table 2 Case 3. These requirements are summarized below.
  - (a) Minimum radial clearance of antennas, equipment and associated support elements from:
    - (i) Span wires, guys, messengers and communication conductors – 2 feet
    - (ii) 0–750 volt conductors including service drops – 4 feet
    - (iii) 750–7,500 volt conductors – 4 feet
    - (iv) 7,500–20,000 volt conductors – 6 feet
    - (v) 20,000 – 150,000 volt conductors – 8 feet
    - (vi) Above 150KV see G.O. 95.
  - (5) Antennas shall maintain a 2 foot horizontal clearance from centerline of pole when installed between supply and communication lines or below communication lines.
  - (6) There is no horizontal clearance from centerline of pole for antennas installed between supply lines or at the top of the pole, but the antenna and support elements must be arranged so that the pole can be safely climbed.

## Installation Details for Service to Pole-Mounted Communication Equipment

- (7) Antennas shall have a vertical clearance above ground as specified in Table 1, Column B Cases 1 to 6a of G.O. 95. This requires antennas that overhang buildings, walkable surfaces, roadways etc. meet the same vertical clearance requirements as communication conductors.

B. Climbing Space must be maintained except for the allowable climbing space obstructions. Reference G.O. 95 Rule 54.7 A (3). Antennas, associated equipment and support elements are not allowed in the climbing space. When antennas are installed above supply lines at the top of the pole, climbing space must be maintained to:

- (1) The bottom of the antenna (including associated support elements) if affixed less than 8 inches from the surface of the pole.
- (2) The top of the pole or pole top extension if the antennas are affixed more than 8 inches from the surface of the pole or pole top extension. When installing pole top extensions refer to document [028691 Pole-Top Extension for Wood Poles](#).

Note: Climbing space can be difficult to maintain with antenna installations due to antenna size, number, configuration, and orientation on the pole. In addition, most installations have multiple risers and vertical runs, grounds, equipment and metering enclosures. As always, good communication, up front, is essential to ensure adequate space is available to accommodate the antenna and all the associated equipment.

- (3) Pole Steps: Stepping must be in accordance with Rule 91.3. No pole steps are to be installed in the supply space or above supply lines except for any necessary steps associated with a pole top extension bracket.
- (4) Risers, grounds and vertical conductor runs on non-metallic structures:
  - (a) Risers, grounds and vertical runs passing supply lines and/or communication lines and/or their associated equipment shall be suitably covered throughout their length, shall be installed outside the climbing space and shall be constructed and maintained in accordance with Rule 54.6-D 1, 2, 3, and 5 (requirements for vertical runs for supply lines).
  - (b) The suitable protective covering (see Rule 22.8) for risers, grounds and vertical runs passing supply lines and/or equipment shall extend no less than:
    - (i) 3 feet above lines energized from 0 – 750 volts
    - (ii) 6 feet above lines energized from 750 – 35,000 volts
    - (iii) 9 feet above lines energized from 35,000 – 50,000 volts
- (5) Risers, grounds and vertical conductor runs on metallic structures that pass supply lines and/or communication lines and/or equipment shall occur on a single structure and shall be installed outside the climbing space in accordance with Rule 54.6-D4.
- (6) Signage: Antennas shall be marked with a sign or signs for each antenna installation. The sign
  - (a) Name / identification of the antenna operator
  - (b) A 24-hour contact number of antenna operator for emergency notification or other information
  - (c) Unique identifier of the antenna installation
  - (d) Indication that the antennas RF output is in compliance with the FCC General Population (G.P.) uncontrolled exposure limits or, if the antenna exceeds those limits indication of the minimum approach distance. See Utility Procedure [TD-2001P-01](#) Procedures for Working Around Antennas for examples of typical RF signage.

(7) Disconnect switch

- (a) Antennas that exceed the FCC's General Population (G.P.) Uncontrolled Limits
  - (i) Require the antenna owner to provide a disconnect switch that is readily accessible to PG&E. This switch must de-energize all sources of power to the antenna, both AC and any battery backup.
  - (ii) Require the antenna owner to establish a protocol, agreed to by PG&E, for powering down the antenna site.
  - (iii) Will be operated by mutual agreement except during emergencies.

Note: Minimum Approach Distances (MADs) must be indicated on the antenna signage.

- (b) Antennas that meet the FCC's General Population (G.P.) Uncontrolled Limits

## Installation Details for Service to Pole-Mounted Communication Equipment

---

- (i) Do not require a disconnect switch for these low power antennas.
  - (ii) Require the wireless company to submit documentation indicating the maximum RF output of the antenna meets the FCC requirements for General Population/Uncontrolled RF exposure.
15. Notification of Conditions to Third Party Utility: If an existing antenna installation is found that does not meet the design and construction requirements detailed in 1 thru 7 above, a 3rd party notification (Form -3447) should be created. Typical problems involve antennas, risers or other equipment installed in the climbing space, inadequate clearances or signage, and antennas installed in the Safety Clearance Zone on joint poles. These conditions present a hazard for workers and must be corrected within the timelines described in Utility Standard [TD-2014S](#) Notification of Conditions to Third-Party Utility.

Also see the, Design and Construction Checklist for Third Party Antennas, for requirements and typical deficiencies.

### 16. Design and Construction Requirements for Antennas and Other Equipment on Streetlight Poles

#### A. Antennas and other equipment on PG&E-owned streetlight poles

- (1) PG&E will not sell ownership interest in a streetlight-only pole. Third party attachments, antennas or other equipment (see note below) may be permitted under a license agreement. Requests from a NCJPA Member to become a joint pole owner (for street light only poles), via Form 2, should be rejected. Refer all requests to PG&E's NRD Department.
- (2) Licensing for third party antennas, gun shot detectors, government owned cameras, and other equipment will be managed by PG&E's NRD Department. Consult with NRD and Electric Distribution Standards for the applicable design, construction and other requirements.
- (3) Where applicable, unmetered attachments to streetlights must also meet the requirements outlined in Form 79-1078 - Agreement for unmetered electric service to devices connected to Pacific Gas and Electric Company's streetlight facilities.
- (4) Antennas are not allowed on poles with decorative, semi-decorative, or "Special facility" streetlights that the customer has chosen from our appliance product mix or outside of the normal product mix. Exceptions may be allowed when the streetlight customer of record states, in writing, that they have no objection to the installation. Refer any requests to PG&E's New Revenue Development (NRD) Department.

### 17. Antennas on customer owned streetlight poles.

- A. Antenna projects involving customer owned streetlight poles will be managed by PG&E's. Streetlight Program Manager. Streetlight poles installed under the following rate schedules are not owned by PG&E therefore any requests for attachment should be directed to the pole owner.
- (1) LS-1C, Customer owns pole and foundation
  - (2) LS-2A, B, and C
  - (3) OL-1
- B. Where the requesting party wants to attach to a PG&E owned streetlight mast arm on a customer owned pole, a letter of approval must be acquired by the requesting party from the PG&E customer receiving lighting service.
- C. A separate energy connection for the antenna must be made under the governing tariff in absence of any special CPUC approved agreement. The 79-1048 agreement (and Rate Schedule LS-2) allows antennas on city owned streetlight poles to utilize the streetlight photo control receptacle as the energy source where the installation meets the loading limitation and all other requirements of the agreement.

## Installation Details for Service to Pole-Mounted Communication Equipment

---

**Table 1 Bill of Material to Be Furnished by the Communication Company**

Item	Description
1	Conduit, Rigid, PVC, Schedule 80 <sup>1</sup> (size as required)
2	Pipe Straps, Galvanized
3	Conduit Fittings (as required)
4	Wire, 600 V, Size as Required
5	Service Weather Head, PVC
6	Meter Panel or SmartPole Meter Enclosure (TD-027911B-002), as required
7	Steps, Pole (if pole is unstepped)

<sup>1</sup> Use Schedule 80 for 1-1/2" or smaller, or Schedule 40 for 2".

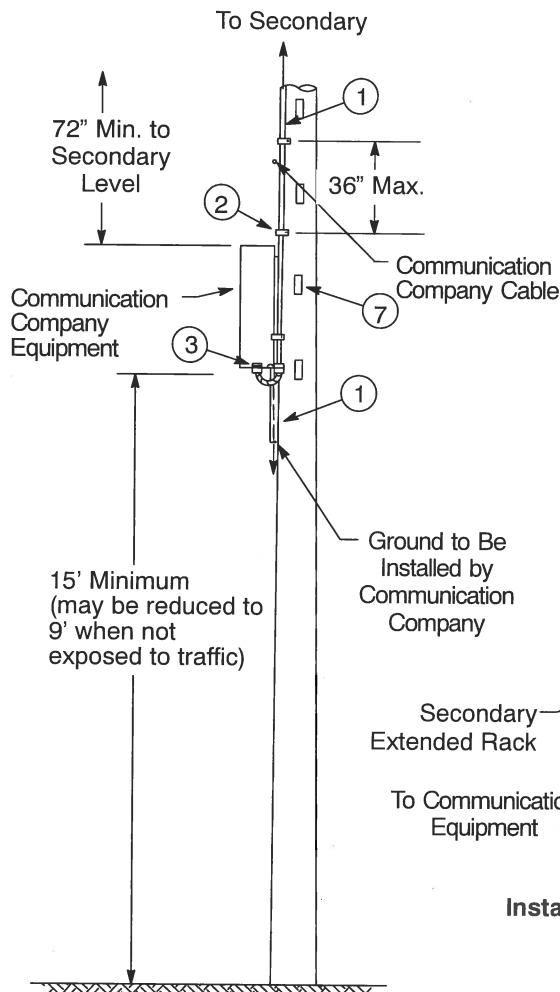
**Table 2 Bill of Material to Be Furnished and Installed by PG&E**

Item	Description	Code	Document
8	Connector, Compression or Wedge (as required)	-	<a href="#">041010</a>
9	Conduit, Rigid, PVC, 2"	360234	<a href="#">021924</a>
10	Meter, Watthour (as required)	-	-

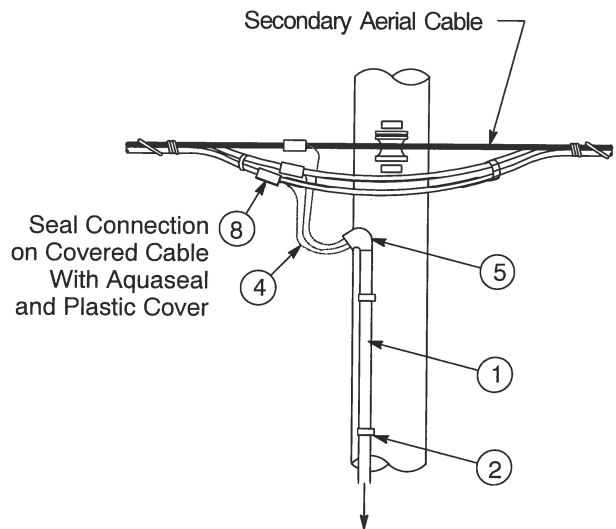
## Installation Details for Service to Pole-Mounted Communication Equipment

**Note**

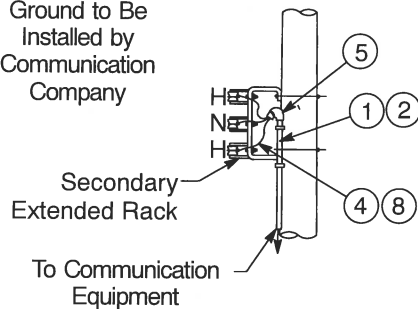
1. Unmetered load may be 2-wire, 120 V or 3-wire, 120/240 V.
2. If a SmartPole Meter is installed a 2-wire, 120 V service is required. See TD-027911B-002 SmartPole Meter for Service to Pole-Mounted Communication Equipment.



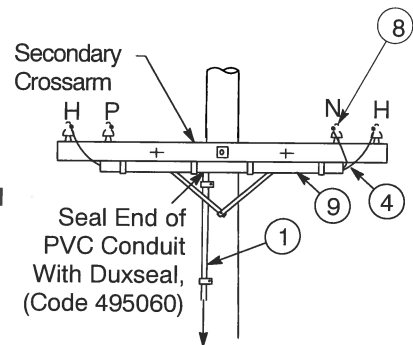
**Figure 1**  
Unmetered Service Connection  
to Communication Equipment



**Figure 2**  
Installation With Aerial  
Cable Secondary



**Figure 3**  
Installation With Extended  
Rack Secondary

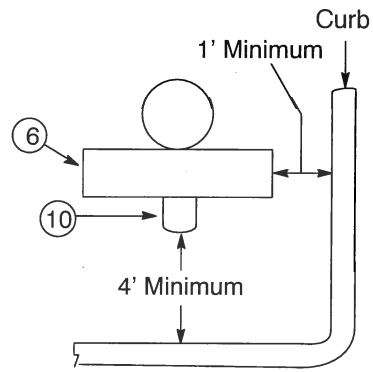
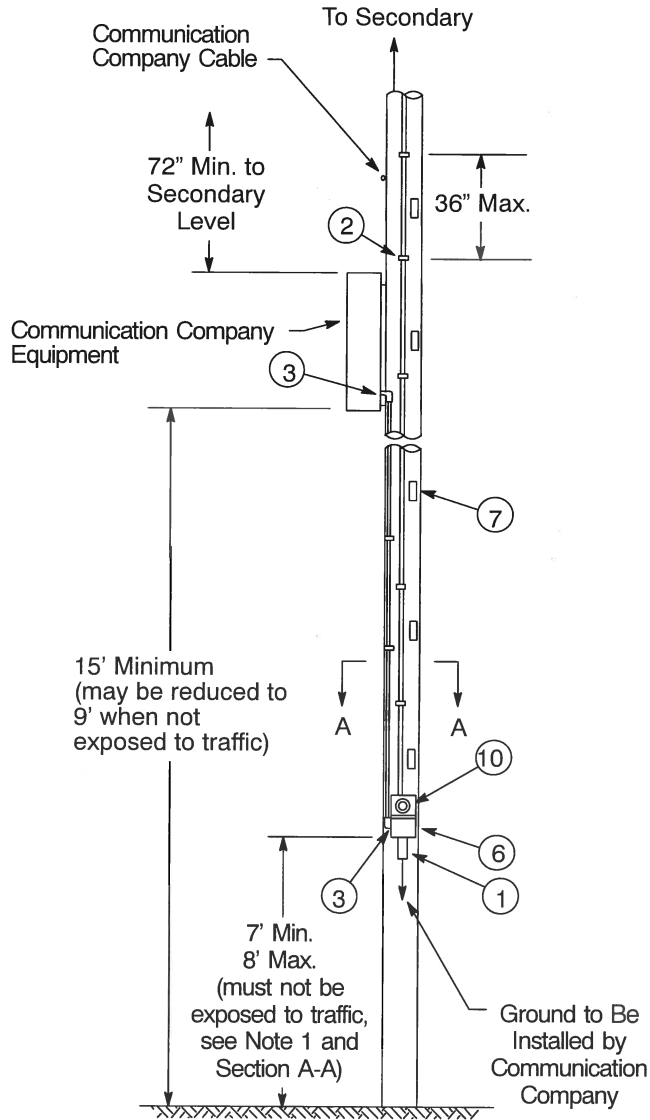


**Figure 4**  
Installation With Crossarm  
Secondary

# Installation Details for Service to Pole-Mounted Communication Equipment

## Notes

1. For poles close to curbs avoid exposure to equipment and personnel. It is best to place the meter on a side of the pole away from traffic. If this cannot be done, the following conditions must be met:
  - A. The meter must be no closer than 4 feet to a curb to provide safe access and reading.
  - B. If the meter panel extends to the side past the pole, it cannot be closer than 1 foot to a curb.



**Section A-A  
(Road with Curb)**  
Note: See Section B-B  
(Road without Curb) on Page 9

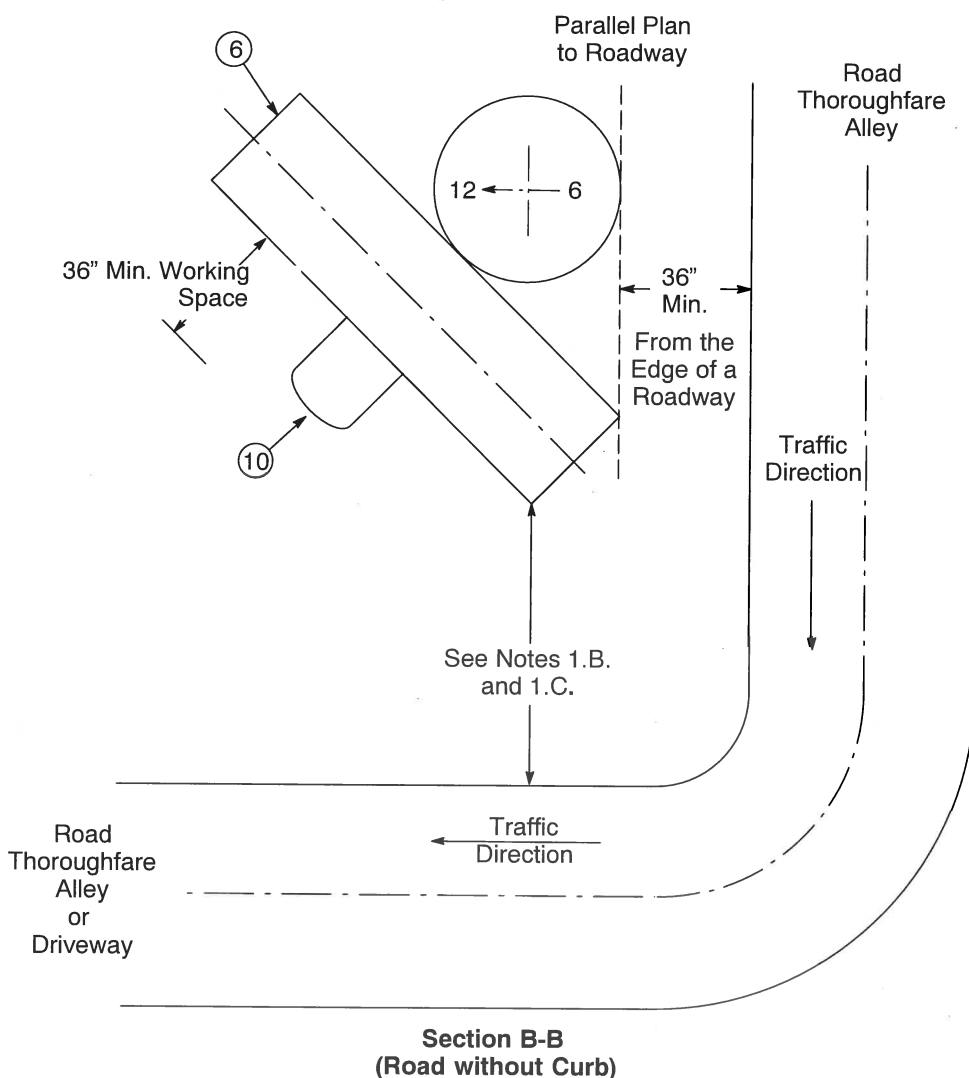
**Figure 5  
Pole-Metered Service Connection to  
Communication Equipment**

## Installation Details for Service to Pole-Mounted Communication Equipment

### Notes

For poles next to roads that have rolled curbs, ramps, or without any curb, avoid exposure to equipment and personnel by placing the meter panel on the back of the pole in the 12 O'clock position. If this cannot be done, one of the following conditions must be met:

1. If the pole is 36" or more away from the edge of the road the meter panel can be placed in a quadrant away from the flow of traffic. For example, in the 10:30 position as shown below. The meter panel must not;
  - A. Extend out past the parallel plane of the pole to the roadway.
  - B. Be closer than 8 feet (96 inches) away from adjacent roads or non-residential driveways.
  - C. Be closer than 4 feet (48 inches) away from residential driveways or sidewalk ramps.
2. Use an approved method of protection (i.e., barrier posts) to prevent contact from vehicles. Prior approval from the Authority Having Jurisdiction (City/County/State) and PG&E may be required.
3. Use a different pole.

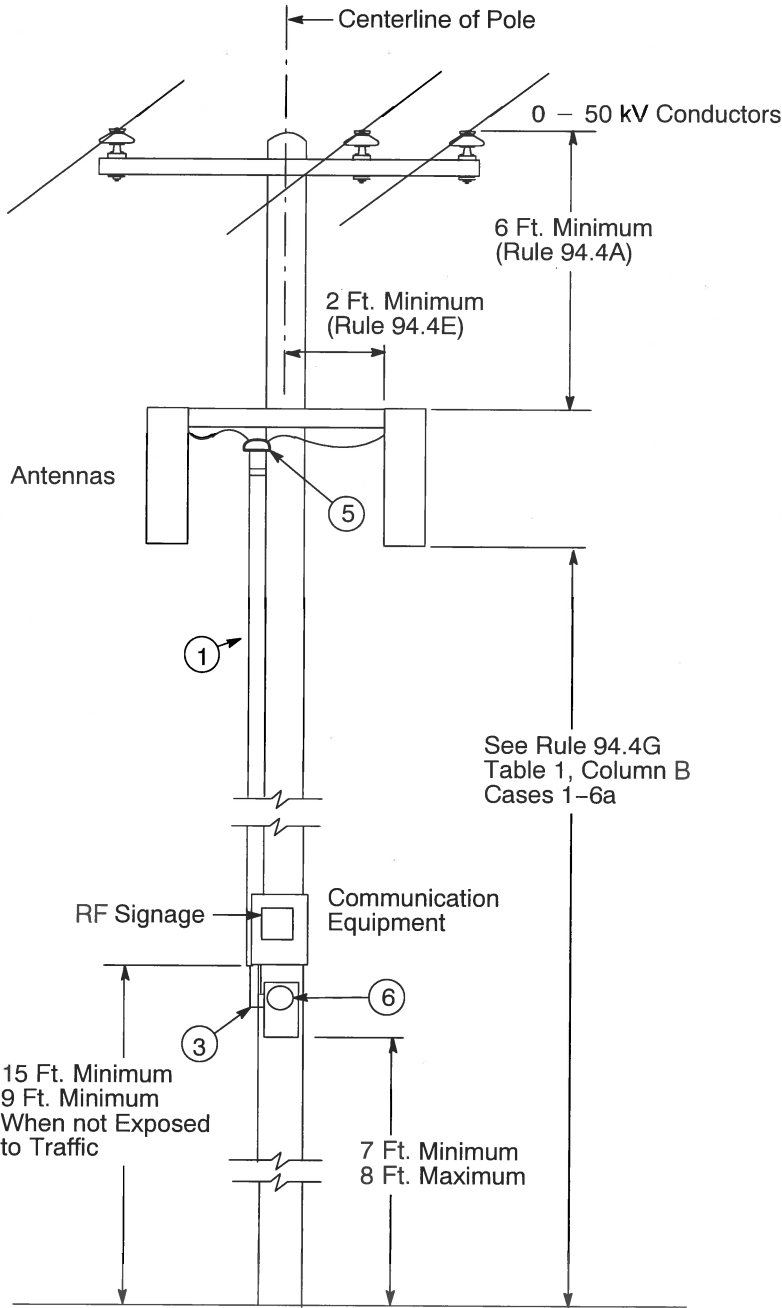




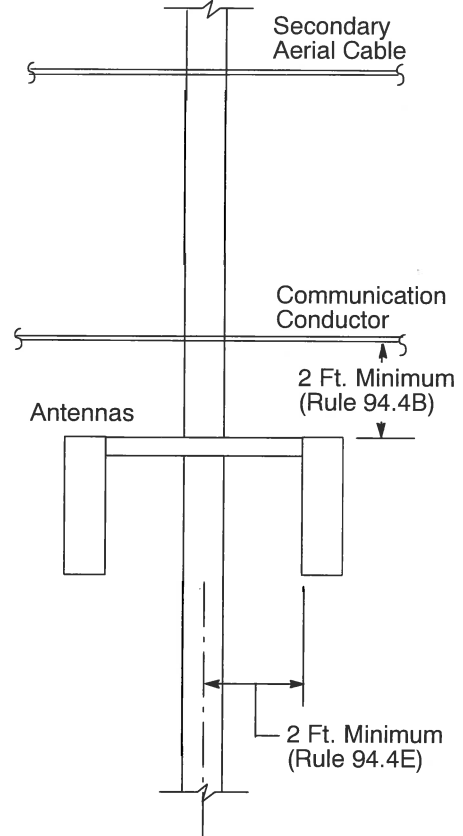
### Installation Details for Service to Pole-Mounted Communication Equipment

**Notes**

- 1. Consideration should be given on reserving additional space (> 6 Ft.) for proposed or future installation of PG&E wires and equipment.

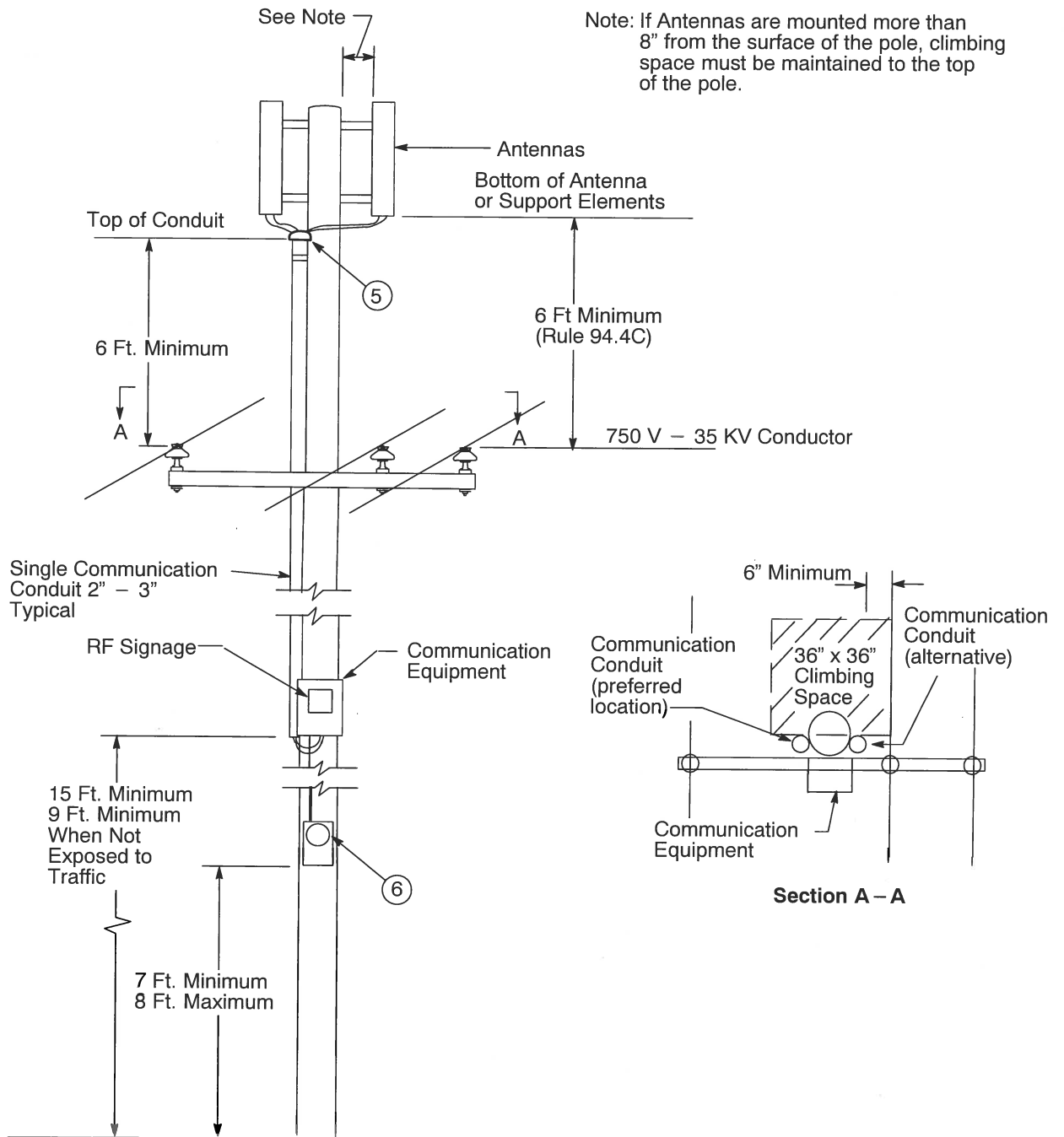


**Figure 6**  
**Antenna - Below Supply Lines**



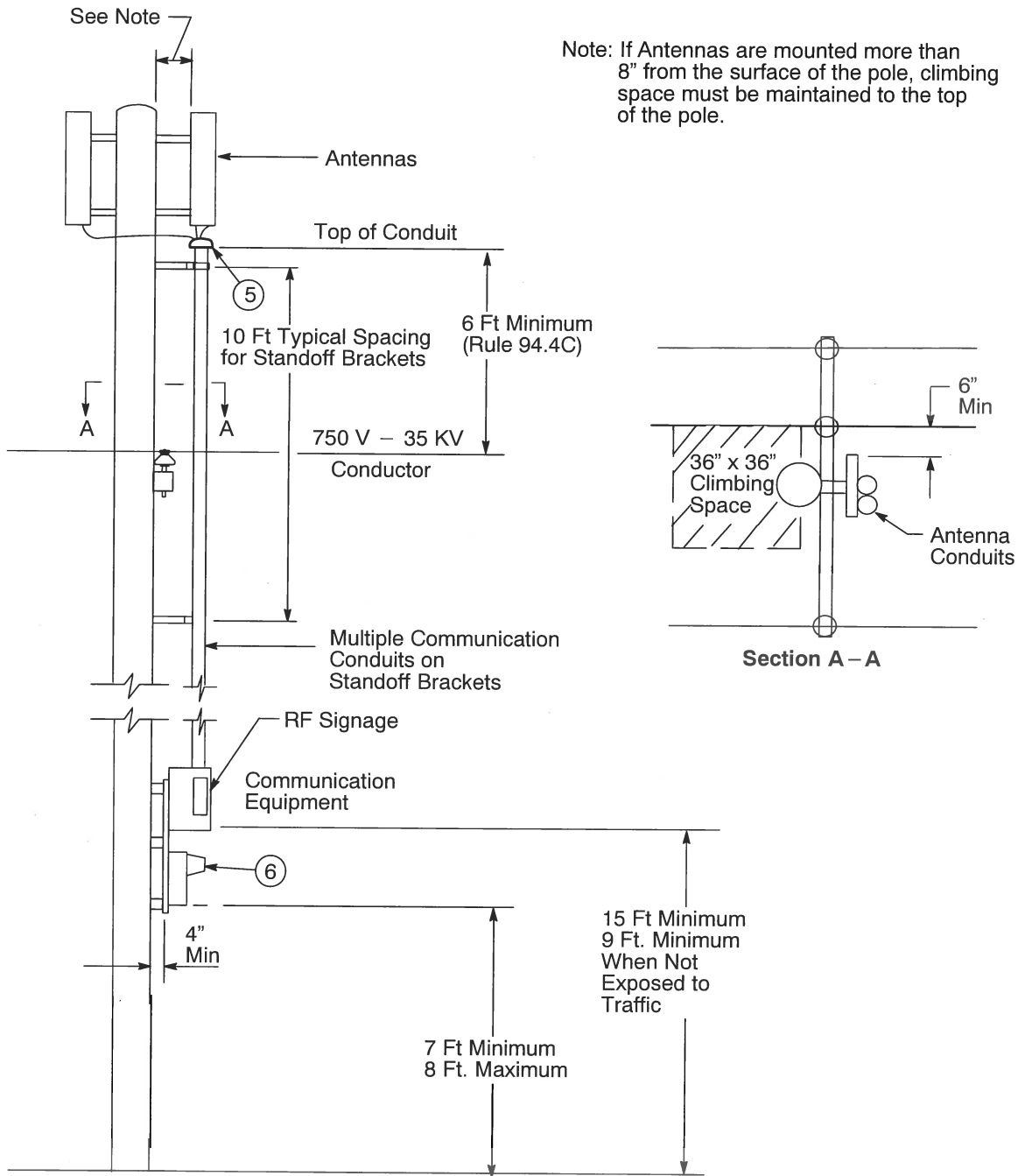
**Figure 7**  
**Antenna - Below**  
**Communication Lines**

### Installation Details for Service to Pole-Mounted Communication Equipment



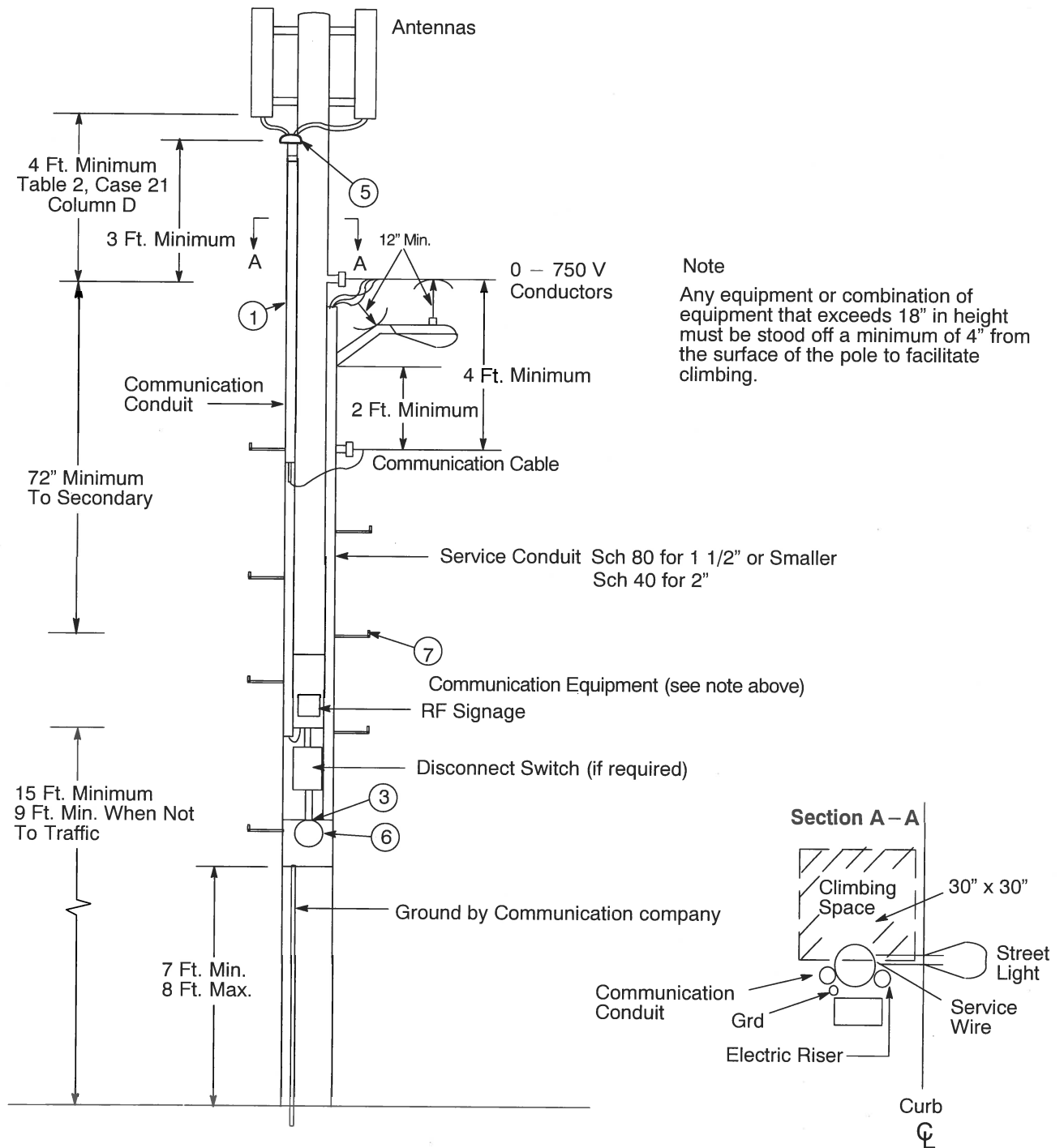
**Figure 8**  
**Pole Top Antenna - Single**  
**Communication Conduit Run**

### Installation Details for Service to Pole-Mounted Communication Equipment



**Figure 9**  
**Pole Top Antenna - Multiple Communication Conduits on Standoff Brackets**

### Installation Details for Service to Pole-Mounted Communication Equipment



**Figure 10**  
Pole Top Antenna - Streetlight Only Poles

**Revision Notes**

Revision 11 has the following changes:

1. Updated Section "Purpose and Scope" on Page 1.
2. Added new notes 1, 2, 5, and 7.
3. Added and updated "References" on Page 2.
4. Updated Note 15.
5. Updated Detail Section B-B on Page 9.